



WISNIOWSKI



Sliding gates | Double-leaf gates | Wickets | Segments | Sport fences

INDUSTRIAL FENCES



INDUSTRIAL FENCES

OVERVIEW 4 – 15

SLIDING GATES 16 – 33

FOLDING GATES 34 – 41

DOUBLE-LEAF GATES AND WICKETS 42 – 55

INDUSTRIAL SEGMENTS AND FENCES 56 – 75

PORTABLE SOLUTIONS 76 – 77

INSPIRATION 78 – 109

Why **WISNIOWSKI**?

We have been manufacturing our products with passion for 30 years.

The name of the WISNIOWSKI brand originates from the last name of the founder and owner of the manufacturing plant, Andrzej Wiśniowski. When products are branded with the last name of the founder, it is a testament to their quality and functionality.

The story began with a dream about remote-controlled garage doors. Today, across over 120,000 square metres of the production floor, we manufacture hundreds of thousands of products each year. Thanks to our advanced technologies, proven materials, and proprietary innovative engineering, our customers can be sure that they are making the right choice.

In our Quality Policy, we declare that we comply with all the regulations applicable to the products we manufacture, including those concerning safety and energy consumption, and with the requirements provided for in the procedures of accredited certification bodies that approve our products for their intended use. In order to fulfil these commitments, we maintain and constantly improve our Integrated Management System that complies with the requirements of the following standards: ISO 9001:2015, OHSAS 18001:2007, ISO 50001:2011.

Our experience guarantees product durability and the company's responsibility throughout the product's lifetime. It is also our promise of the highest quality and safety of use.

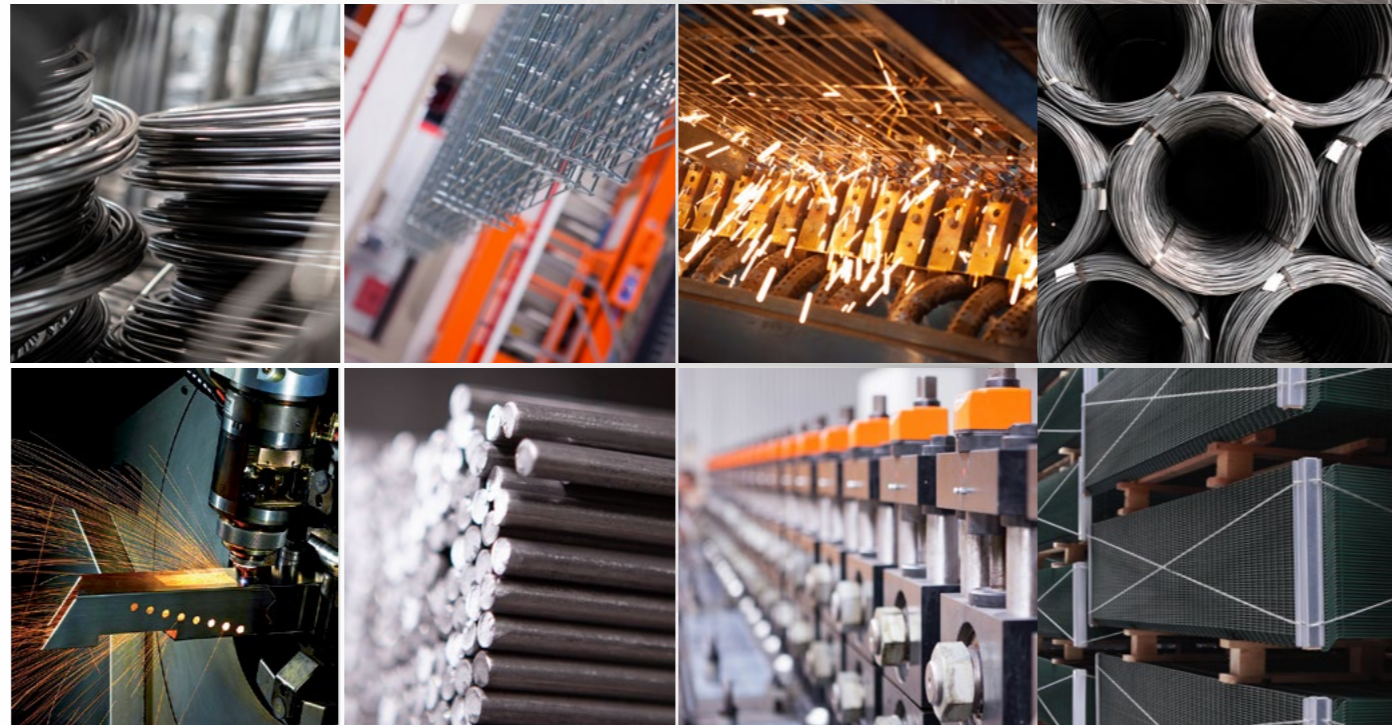

WISNIOWSKI Crowning your investment.

Welcome to the world of **WISNIOWSKI FENCES**

When choosing an industrial fence by WISNIOWSKI, you receive a product designed and manufactured using modern technology, based on the know-how and years of experience of our designers, construction engineers, and specialists.

We make our products out of passion for systems of well-thought-out solutions, and our diligence in making them guarantees top quality. All the system elements are checked and tested, safety-certified and provided with a 10-year corrosion protection warranty.



LONGEVITY

All WISNIOWSKI fencing system elements are rust-protected with top anticorrosive coating achieved by galvanising and powder painting. It is hot dip galvanising of a chemically cleaned construction that provides dozens of years of rust protection to WISNIOWSKI fencing system elements.



DUPLEX SYSTEM – DOUBLE PROTECTION

Combined galvanised and varnish coatings in the DUPLEX system make WISNIOWSKI fencing serve considerably longer. In all weather conditions WISNIOWSKI fencing will look attractive. RAL colour palette application makes a selection of polyester coating colour easy.



EFFICIENT PROTECTION

Galvanising is an efficient economically technique in terms of both production and maintenance. Galvanised fencing by WISNIOWSKI does not require surface maintenance for years. Rust-proofing no longer means expensive treatments as with traditional fencing. Galvanised steel may be recycled so it does not litter or burden the environment.



PROOFED IN EVERY CONDITIONS

Galvanising by WISNIOWSKI complies with the European norm PN-EN ISO 1461 which guarantees proper quality of galvanised products. Galvanised coating is resistant to both high and low temperatures and UV radiation for best protection of steel surfaces.

*WISNIOWSKI provides a 10-year warranty for corrosion protection of gates, wickets, segments, and posts processed by hot-dip galvanizing and powder coating.

Safety

of the fenced property is not just about the confidence that the premises are protected around the perimeter. WISNIOWSKI industrial fences guarantee full safety of use. All the gates fitted with control devices provide high safety of use thanks to safeguards such as photocells, safety edges, signal lights, and a warning signal light. All our gates carry a CE marking in accordance with the PN EN 13241-1 European standard.



SAFETY

Reliability

is the most important quality of moving elements whenever machine operation must be quick and effective. With WISNIOWSKI fence systems, you can be sure that the fence will provide everything it was designed to provide. It constitutes a protective enclosure, marks out the perimeter, and the automatic gates are an active barrier that operates efficiently as required by the user.



EFFICIENCY

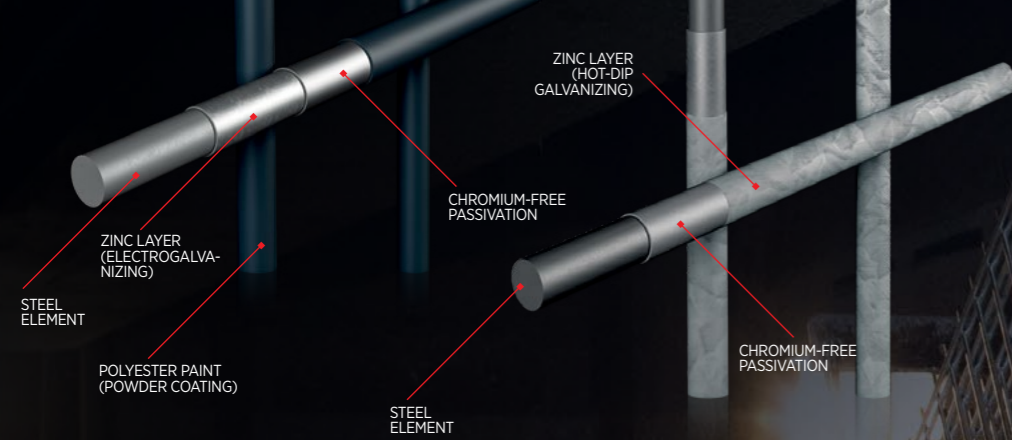

Mesh panel protected by: **electrogalvanizing and polyester coating**

Mesh panel protected by: **hot-dip galvanizing**

Effective protection

Corrosion treatments

Galvanizing is an economically efficient technology both at the manufacturing stage and in long-term use. Galvanized industrial fences by WISNIOWSKI do not require surface treatment for many years. When in use, their elements do not have to be coated with the use of expensive products and complex renovation methods that traditional fences need. Depending on the type of the fence element, two galvanizing methods are used: hot-dip galvanizing and electrogalvanizing, which provide a great substrate for powder coating.

Galvanized steel is recycled and does not place a burden on the environment.



ANTI-CORROSIVENESS

An abundance of colours

The range of RAL colours is a selection of over 200 catalogued traditional colours optionally available with WISNIOWSKI fences.

The paint coat is applied in automatic, modern, fence-specific powder paint shops. The special pre-treatment cycle for the substrate and a stable process of thermal fixing of the coating provides an exceptional finish. Yet above all, the powder coating technology provides high quality corrosion protection backed by our 10-year warranty for the WISNIOWSKI fences painted using the DUPLEX technology.



Blue RAL 5010 Green RAL 6005 Graphite RAL 7016 Grey RAL 7030 White RAL 9016

Standard colour range for industrial fences.



Standard RAL palette colours

Sliding gates

Reliable and efficient operation

A reliable and solid construction of the cantilever design lets you close off really big openings – up to 16 metres wide with a single sliding gate and up to 24 metres wide when two gates are installed opposite each other. Two opening directions are available: left and right, in manual or power operated versions. They are used when the forecourt is short, when the ground is elevated, and whenever double-leaf gates cannot be used.

Industrial sliding gates travel along the fence; for its installation and proper operation, free space is required on the side of the opening to enable free movement of the leaf.

WISNIOWSKI sliding gates are perfect for all types of private and industrial business activity. The gates are installed around industrial buildings, airports, ports, guarded car parks, around schools, kindergartens, shopping malls, etc.

Special features

The broad range of dimensions: opening from 3 to 16 m wide.

System-based product – can be infilled with 25x25, 25x25 Caro, 18x30, tube \varnothing 25 mm infills, VEGA B or VEGA 2D Super mesh panels.

Safety - available with the following operating modes: manual, Totmann, and Automatik.

1195



WISNIOWSKI



EFFICIENCY

WISNIOWSKI

Sliding gates

Gate types

Industrial sliding gates are made of steel box sections. This modular, cantilever design has no welds at the joints of gate elements, which made it possible to eliminate possible corrosion centres.

Depending on the required clear opening width, 3 types of track beams are used: PI 95 (95x85), PI 130 (130x115), and PI 200 (200x155).



PI 200 sliding gate
Gate with a drive in the high box

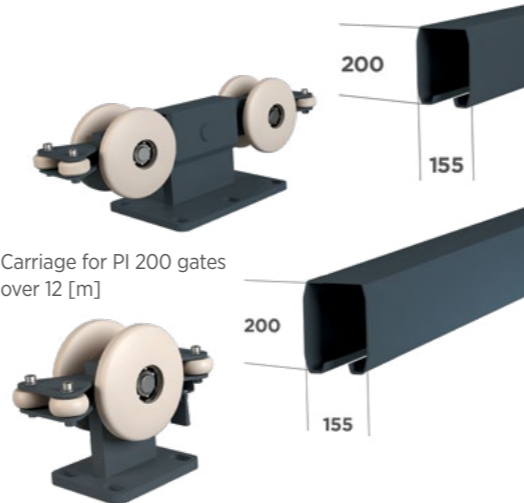

Carriage for PI 200 gates over 12 [m]

Carriage for PI 200 gates up to 12 [m]

PI 200

Available dimensions of PI 200 gates

Products are available in all sizes for the range provided in the table.

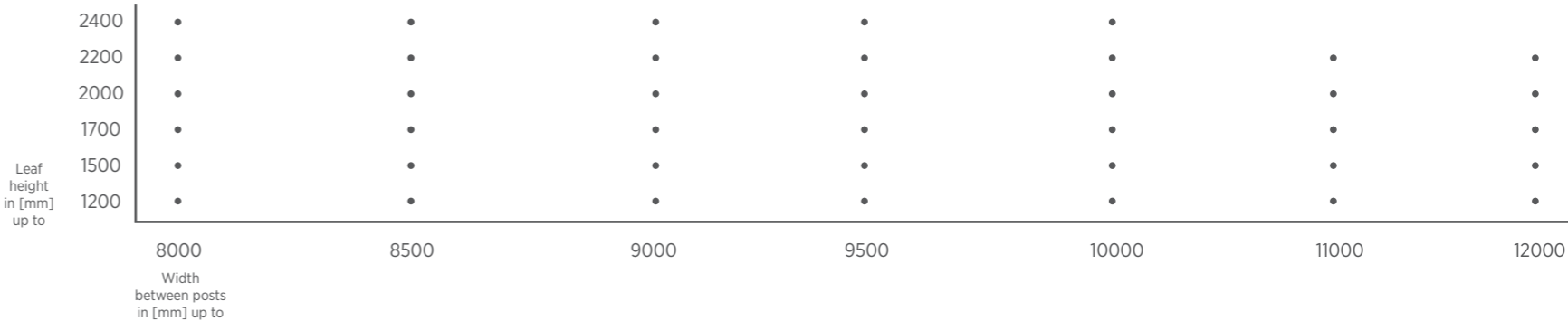

PI 200 sliding gate
Sliding gate with a drive in the low box



PI 200 sliding gate
Manually operated sliding gate

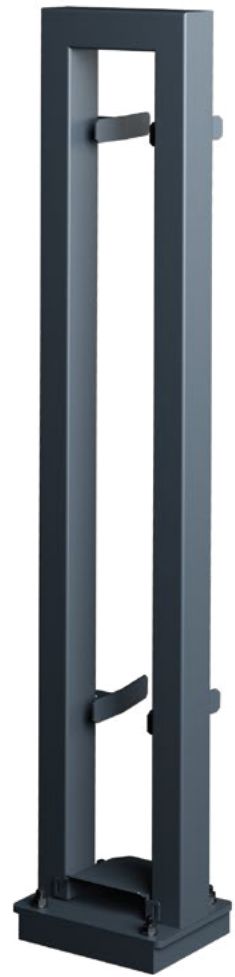

PI 130 sliding gate
Gate with a drive in the high box



Carriage for PI 130 gates

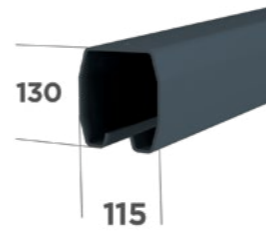

PI 130 sliding gate
Sliding gate with a drive in the low box



PI 130 sliding gate
Manually operated sliding gate

PI 130

Available dimensions of PI 130 gates

Products are available in all sizes for the range provided in the table.

| Leaf height in [mm] up to | 6000 | 6500 | 7000 | 7500 | 8000 | 8500 | 9000 |
|---------------------------|------|------|------|------|------|------|------|
| 2400 | • | • | • | | | | |
| 2150 | • | • | • | • | • | | |
| 1950 | • | • | • | • | • | • | |
| 1650 | • | • | • | • | • | • | • |
| 1450 | • | • | • | • | • | • | • |
| 1200 | • | • | • | • | • | • | • |
| 1000 | • | • | • | • | • | • | • |

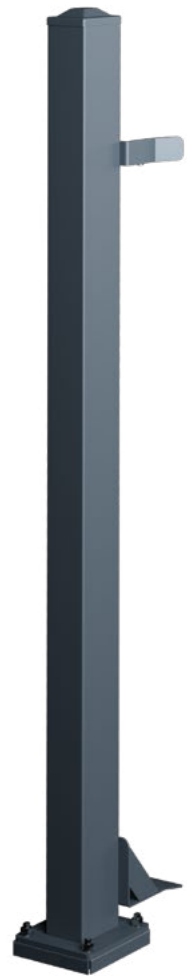

PI 95 sliding gate
Sliding gate with a drive in the post

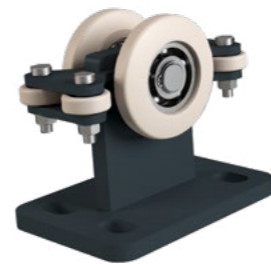

Carriage for PI 95 gates

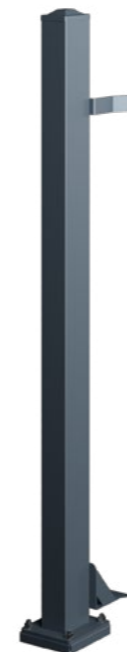
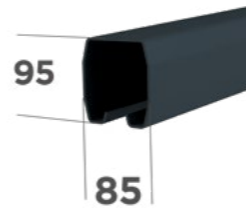

PI 95 sliding gate
Manually operated sliding gate

PI 95

Available dimensions of PI 95 gates

Products are available in all sizes for the range provided in the table.

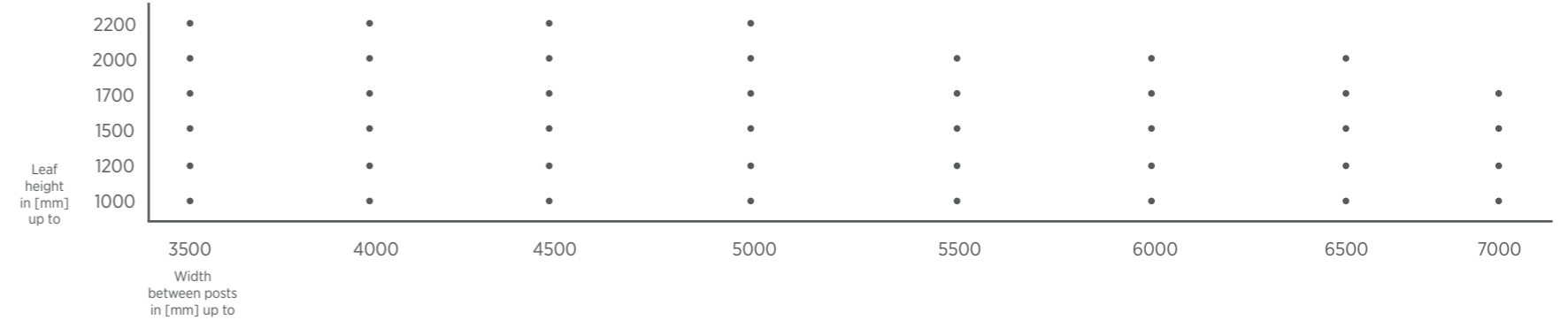

Sliding gates

Infill types



25x25 section infill

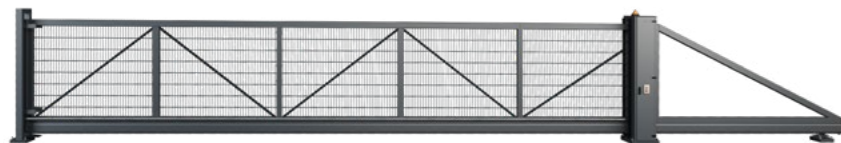

VEGA 2D Super panel infill (screwed panels)



Round tube section infill 25 [mm] (welded to the structure)



Profile infill 30x18 [mm] (welded to the structure)



NEW Horizontal sheet infill 1 [mm] thick with 20 [mm] spacing between the panels (residential infill design)

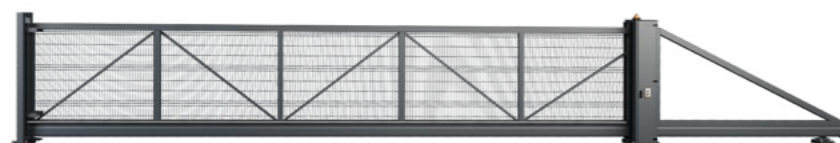

VEGA B mesh panel infill (screwed to the structure)



VEGA 2D Super panel infill (welded to the structure)



Section infill 25x25 [mm] in the Caro arrangement (welded to the structure)



NEW Horizontal infill (shutter infill) made of formed sheet 0.75 [mm] thick (residential infill design)

Sliding gates

Automation solutions

A wide selection of drive units depending on the gate size and intended purpose. Our range includes drive units with various power output, speed, and duty specifications.

All the automatic gates by WISNIOWSKI carry a CE marking confirming that the products comply with the PN EN 13241-1 standard.

Optional integration of the drive unit is an important feature of the WISNIOWSKI sliding gates. We offer integration of the drive unit with a post and a low or high box.

The integration of the drive unit guarantees reliable operation of both the drive unit and the controller. It is also a proven solution preventing theft.



SAFETY

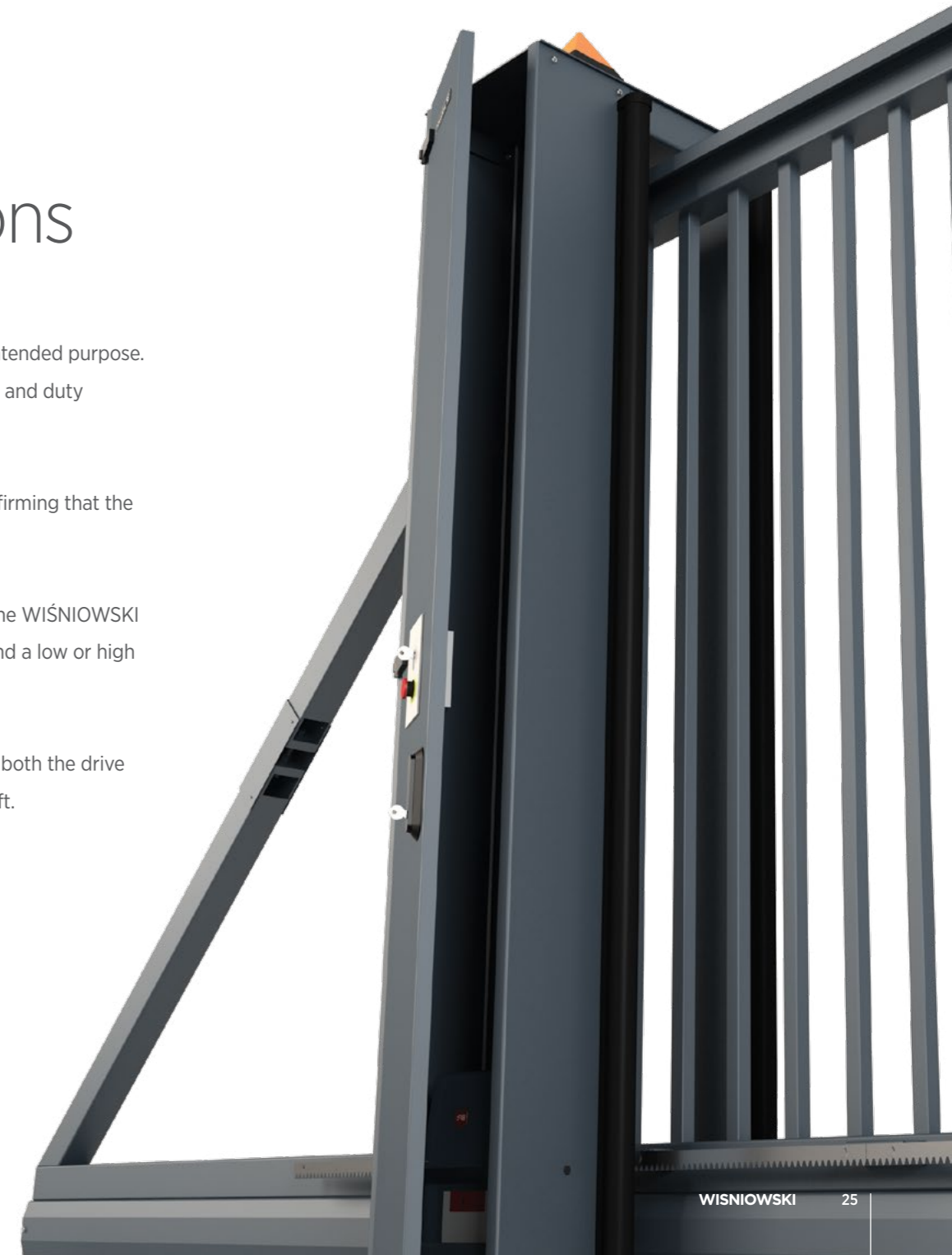

Accessories

Automation solutions

The PI 200 gates are available in the manually-operated and power-operated versions. The manually-operated version is fitted with a Locinox lock.

The automatic gate is not fitted with a lock, as the operating unit doubles up as a lock. The automatic gate is especially recommended for premises where the gate has to be frequently opened and closed. In this case, the automatic drive unit is a very convenient solution.

Depending on the required level of safety, the automatic gate is available in the Totmann (operated with a key switch) or the Automatik (operated with a remote control transmitter) version. Depending on the requirements, the automatic version is fitted with 3 safety edges (Automatik 1) or 5 safety edges (Automatik 2). The CE mark confirms safe operation of the PI 200 sliding gates in all conditions.



The Totmann version

- Actuator
- Central control unit
- Warning lamp
- Key switch with an emergency STOP switch



The Automatik 1 version

- Actuator
- Central control unit
- Radio receiver
- Transmitter for controlling the drive remotely
- Warning lamp
- External antenna
- Photocells
- Key switch with an emergency STOP switch
- **3 safety edges**
- Signal transmission system for transmitting the signal from the safety edge installed on the leaf



The Automatik 2 version

- Actuator
- Central control unit
- Radio receiver
- Transmitter for controlling the drive remotely
- Warning lamp
- External antenna
- Photocells
- Key switch with an emergency STOP switch
- **5 safety edges**
- Signal transmission system for transmitting the signal from the safety edge installed on the leaf

NEW

Sliding gates on wheels

Gate types

Sliding gates on wheels are structures made of steel box sections. The bottom section of the gate is reinforced with a beam to which running wheels are fitted. The gate moves along the running track fixed to the ground. Leaf with a system infill. The gates are available in a manually-operated and a power-operated version.



WI 200 sliding gate on wheels
Automatic sliding gate with external drive

Track for gates up to 10 [m] wide
Reinforced track for gates over 10 [m] wide

WI 200 | WI 120

Available dimensions of WI 200 and WI 120 gates

Products are available in all sizes for the range provided in the table.

| | WI 120 ON TRACKS 120x80x3 | | | | | WI 200 ON TRACKS 200x80x4 | | | | |
|-----------------------------------|---------------------------|------|------|------|------|---------------------------|------|-------|-------|-------|
| Leaf height in [mm] up to | 3000 | 4000 | 5000 | 6000 | 7500 | 8000 | 9000 | 10000 | 11000 | 12000 |
| Width between posts in [mm] up to | • | • | • | • | • | • | • | • | • | • |
| | • | • | • | • | • | • | • | • | • | • |
| | • | • | • | • | • | • | • | • | • | • |
| | • | • | • | • | • | • | • | • | • | • |
| | • | • | • | • | • | • | • | • | • | • |
| | • | • | • | • | • | • | • | • | • | • |



WI 120 sliding gate on wheels
Manually operated sliding gate



WI 120 sliding gate on wheels
Automatic sliding gate with external drive

Sliding gates on wheels

Infill types



25x25 section infill

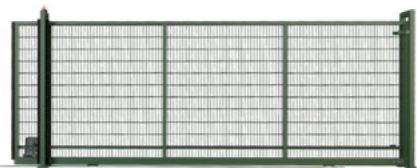

VEGA 2D Super panel infill (welded to the structure)



Profile infill 30x18 [mm] (welded to the structure)

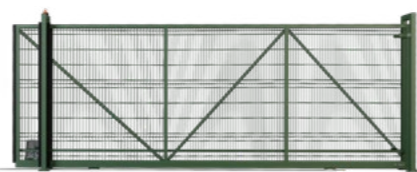

VEGA B mesh panel infill (screwed to the structure)



Round tube section infill 25 [mm] (welded to the structure)

Sliding gates on wheels

Automation solutions

A wide selection of drive units depending on the gate size and intended purpose. Our range includes drive units with various power output, speed, and duty specifications.

All the power operated gates in the WISNIOWSKI range were awarded the CE mark, which confirms the products' compliance with the provisions of PN-EN 13241-1.



Accessories

Automation solutions

Gates on wheels are available in a manually-operated and a power-operated version. The manually-operated version is fitted with a Locinox lock. The automatic gate is not fitted with a lock, as the operating unit doubles up as a lock. The power-operated gate is especially recommended for places where the gate has to be frequently opened and closed – an automatic operating unit is a convenient solution in such cases.

Depending on the required level of safety, the power-operated gate is available in the Totmann (operated with a key switch) or the Automatik (operated with a remote control transmitter) version. Depending on the requirements, the gate is fitted with 3 safety edges (Automatik 1) or 5 safety edges (Automatik 2).



The Totmann version

- Actuator
- Central control unit
- Warning lamp
- Key switch with an emergency STOP switch



The Automatik 1 version

- Actuator
- Central control unit
- Radio receiver
- Transmitter for controlling the drive remotely
- Warning lamp
- External antenna
- Photocells
- Key switch with an emergency STOP switch
- **3 safety edges**
- Signal transmission system for transmitting the signal from the safety edge installed on the leaf



The Automatik 2 version

- Actuator
- Central control unit
- Radio receiver
- Transmitter for controlling the drive remotely
- Warning lamp
- External antenna
- Photocells
- Key switch with an emergency STOP switch
- **5 safety edges**
- Signal transmission system for transmitting the signal from the safety edge installed on the leaf

Clear passage up to 10 m 20 m

V-KING gates

The V-King folding gates are dedicated for industries where quick, heavy duty, reliable, and safe operation is needed. This solution is perfect for logistics centres, ports, airports, and other industrial areas.

The V-King combines the advantages of a double-leaf gate and a barrier, enabling permanent access control or traffic control.

Special features

Reliable - top priority ever since the design concept stage. The structure, as well as the selection of accessories and the drive unit were all taken into consideration with a view to ensuring the highest reliability.

Safety. 10 safety edges come as standard. With emphasis on safety, the gate was fitted with systems preventing situations where property, e.g. a passing vehicle, could be damaged or a person could be injured.

High-speed - adjustable operating speed from 1 m/s, indispensable when a high level of perimeter protection is needed at sites with a high traffic volume. Moreover, drive units with the best reliability factor are used.

Heavy duty operation. The reinforced structure of the gate is designed for continuous operation.



Safety of use

of this ultramodern and high-speed gate is ensured by numerous safety systems. The standard accessories include 2 photocell kits, 10 safety edges, two emergency stops, and a LED warning light. The gates can be fitted with auxiliary infrared barriers and light barriers. All this to make sure that the gate can operate without additional supervision in high-volume vehicle or pedestrian traffic.

The V-King gate is available in a single-leaf and a double-leaf version. The gate can close off opening widths up to 10 [m] wide and 2.5 [m] high.

Confidence confirmed with a 5-year warranty for the complete product.



V-KING gates Automation solutions

Drive units with an oil bath gear are dedicated for heavy duty operation and are characterized by reliability and smooth operation – adjustable opening speed from 1 m/s. The reliability of the drive unit was proven by field tests.

500 000 cycle warranty.



Clear passage up to 6 m 10 m 20 m

TRAFFIC gates

The Traffic folding gate is a solution for users who value fast operation, reliability, security and safety. The operating speed of 0.6 m/s and as many as 250 cycles per day is a combination that is simply a must in some situations. The gates are proven in areas such as housing estates, car parks, and logistics centres. The Traffic gates were awarded the CE mark, which confirms the product's compliance with the provisions of PN-EN 13241-1. The gates are available with the Totmann and Automatik operating mode.

200 000 cycle warranty.



EFFICIENCY



Double-leaf gate and wicket system

BASTION

The BASTION gate and wicket system was conceptualized as a special design for all sorts of industrial operations, especially where simple form and functionality are required. The concept involved preparation of ready product kits. The gate or wicket kit includes load-bearing posts and the hinge and lock kit.

The BASTION is available with three types of infills: 25x25 [mm] closed box section, VEGA B mesh panel screwed to the structure or VEGA 2D Super mesh panel screwed or welded to the structure.

A wide range of optional accessories and dimensions makes the BASTION a versatile solution, which is ready to use without any extra elements. BASTION double-leaf gates carry a CE marking confirming their compliance with the PN EN 13241-1 standard. BASTION wickets can be fitted with a standard lock with a cylinder or an electromagnetic lock.

Special features

Ready-to-use kit. The gate or wicket kit is always paired with posts, it is available in a broad range of dimensions – you can choose any dimension from the available range.

A system solution. Can be infilled with 25x25, 25x25 Caro, 18x30, tube \varnothing 25 mm infills, VEGA B or VEGA 2D Super mesh panels.

A robust and heavy duty structure for industrial applications.



SAFETY

Double-leaf gate and wicket system

GARDIA

The GARDIA gate and wicket system was conceptualized as a comprehensive, lightweight, and very functional solution for moving fence elements, to be applied in single-family detached homes, public buildings, and industrial sites. The gate or wicket kit includes load-bearing posts and the LOCINOX hinge and lock kit with an interchangeable locking direction and up to 180° opening. The leaf is infilled with a 6/5/6 gauge wire VEGA 2D mesh panel welded to the structure or 8/6/8 VEGA 2D Super mesh panel.

The unique design of the GARDIA system makes it possible to have it open in any swing direction. Manual operation only.

Standard finish of the system: hot-dip galvanized or green (RAL 6005) or grey (RAL 7016) colour.

10 year corrosion protection warranty for gates treated with the DUPLEX powder coating system.

Special features

Robust structure with a lightweight infill. Robust structure with a lightweight infill. The combination of a solid structure with panel infills comprising VEGA 2D (6/5/6) and VEGA 2D Super (8/6/8) panels, as well as sturdy load-bearing posts.

Versatile application. The solution can be used in residential buildings and in recreational sites (parks and gardens), as well as in industrial sites thanks to the universal installation in demanding operating conditions, which is enabled by the 180° hinges.



DURABILITY

Double-leaf gate and wicket system

GARDIA Light

The Gardia Light single- and double-leaf gates and wickets constitute a system based on a light 40x40 mm construction with a VEGA 2D (6/5/6) panel infill.

The system is dedicated for residential areas, around properties, parks, allotment gardens, as well as smaller industrial buildings. Gates and wickets with posts and a hinge and lock kit.

Special features

A system-based solution. The Gardia Light system matches the VEGA 2D (6/5/6) and VEGA 2D Super (8/6/8) mesh panels and the Gardia system gate. This makes it possible to make up a complete fence in a single design.

A comprehensive solution. A set including load-bearing posts and a hinge and lock kit. Bolt for the single- and double-leaf gate.



SAFETY

Clear passage up to 6 m 20 m



Sliding gates system

GARDIA

The Gardia cantilever gate is a solution that constitutes an important element of access control for passages up to 6 m wide. The proven leaf structure infilled with a VEGA 2D (6/5/6) or VEGA 2D Super (8/6/8) panel is seated on a support plate fixed to the floor with 3 foundation anchors (B-3 installation). A gate set including the lock post fitted with a roller catcher.

Special features

A system-based solution. The Gardia sliding gate is part of a fence system that includes single- and double-leaf gates, as well as the Gardia wicket. In combination with the VEGA 2D or VEGA 2D Super mesh panels, it constitutes a uniform fence.

The Gardia gates are available in the following operating modes: manual, Totmann or Automatik. The gate was awarded the CE mark, which confirms the product's compliance with European directives and the PN-EN 13241-1 standard.



DURABILITY

Double-leaf gate and wicket system

MODEST

The MODEST gate and wicket system is dedicated for residential, public, industrial and recreational sites alike. Its distinctive feature is the possibility to match the gate and wicket infill with the fence made of WISNIOWSKI mesh panels. The gate and the wicket are infilled with welded-in mesh panels type VEGA B. The robust load-bearing posts and the hinge and lock kit form an integral part of the gate and wicket system. The double-leaf gate includes a deadbolt with a limiter.

Opening method – manual. Available swing directions: PW (right inswing) and LW (left inswing). The system also includes the MODEST sliding gates.

10 year corrosion protection warranty for gates treated with the DUPLEX powder coating system.

Special features

A harmonious line of fences. The VB panel infill welded to the structure perfectly matches the fence system with VEGA B or VEGA B Light mesh panels.

A comprehensive solution. A kit including load-bearing posts and a hinge and lock kit.

Classic colours. The system is available in the following finishes – hot-dip galvanized and in two standard colours: green (RAL 6005) or graphite (RAL 7016).



Clear passage up to 5 m

20 m

Sliding gates system

MODEST

The MODEST cantilever gate combines a durable structure with the VEGA B infill welded to the structure. Together with other elements of the system: a single- or double-leaf gate, wicket, and mesh panels, the gate can make up a complete fence for both residential and industrial areas. The gate is available with the following operating modes: manual, Totmann, and Automatik, and provides access control for passages up to 5 m wide.

Special features

Easy installation. Carriages seated on a support plate. B-3 installation type (with 3 foundation anchors). Catcher post with a roller catcher included.

A system-based solution. A gate system including a single- and a double-leaf gate, as well as the MODEST wicket and VEGA panels.



SAFETY

Double-leaf gate and wicket system

GARDEN

The GARDEN system includes gates and wickets with a lightweight mesh panel infill with a 4 [mm] wire gauge and 50x50 [mm] mesh. This unique solution makes it a perfect alternative or complement to chain-link fences.

Available in the following finishes – hot-dip galvanized and in two standard colours: green (RAL 6005) or graphite (RAL 7016).

10 year corrosion protection warranty for gates treated with the DUPLEX powder coating system.

Special features

Universal swing direction. The kit always includes load-bearing posts and a hinge and lock set enabling any swing direction to be obtained.

Simple, lightweight structure. A light mesh panel infill makes it possible to complement the classic lines of traditional chain link fences.

A ready-to-use kit or individual elements of the system. Gates and wickets are available as kits with load-bearing posts and the hinge and lock set. The leaves are also available individually to install to the existing posts.

Custom configuration and combination of gate and wicket leaves to create an asymmetrical division of leaves is available.



SAFETY

OPO OPZ OPZH OPR OPC OP INDUSTRIAL SEGMENTS

Industrial segments made of the OP series sections constitute yet another element of system solutions for industrial fences by WISNIEWSKI. They enable quick and efficient fencing of the area and form a complete solution with the system of load-bearing posts. We offer OPO open structure segments, where sections are pass-through welded or outer welded to crosspieces, as well as OPZ closed structure and OPZH semi-open structure industrial segments. They combine stability and robustness. With a range of industrial gates and wickets, these simple form segments make for a compact and functional system. They give the fenced area a modern and at the same time elegant look. Available in a number of standard dimensions or designed and custom made as required within the specified dimensions.

Available in all RAL palette colours. Up to 10 year corrosion protection warranty for gates treated with the DUPLEX powder coating system.

Special features

Simple form, solid structure. The classic design of segments with steel sections provides both top technical characteristics and a great appearance for industrial and special-purpose sites.

Tailored to your needs. Available in standard cost-effective dimensions or tailor-made within the specified dimensions.

Easy installation. Installation to steel or concrete load-bearing posts using specially designed system accessories by WISNIEWSKI.



ANTI-CORROSIVENESS

WISNIEWSKI

57

OPO OPZ OPZH OPR OPC OP

INDUSTRIAL SEGMENTS



OPO 201

OPO 201 segments are an industrial solution made of 20 x 20 [mm] box sections pass-through welded to 40 x 30 [mm] box section crosspieces.

Maximum height of segments: 2 [m].

Can be installed to steel or brick posts.



OPO 251

OPO 251 segments are an industrial solution made of 25 x 25 [mm] box sections outer welded to 40 x 27 [mm] box section crosspieces.

Maximum height of segments: 2 [m].

Can be installed to steel or brick posts.



OPZ 252

OPZ 252 segments are an industrial solution made of 25 x 25 [mm] box sections welded to the inside of the 40 x 40 [mm] box section frame.

Maximum height of segments: 2.4 [m].

Can be installed to steel or brick posts.



OPZH 253

OPZH 253 segments are an industrial solution made of 25 x 25 [mm] box sections outer welded to 40 x 27 [mm] box section crosspieces.

Maximum height of segments: 2.4 [m].

Can be installed to steel or brick posts.



OPR 25

OPR 25 segments are industrial segments made of round tube sections \varnothing 25 [mm] in a semi-closed construction welded to closed box sections 40x27 [mm].

Maximum height of segments: 2.4 [m].

Can be installed to steel or brick posts.



OPC 25

OPC 25 segments are industrial segments made of closed box sections 25 x 25 [mm] in the Caro arrangement with a semi-closed construction welded to closed box sections 40x27 [mm].

Maximum height of segments: 2.4 [m].

Can be installed to steel or brick posts.



OP 318

OP 318 segments are industrial segments made of closed box sections 18x30 [mm] in a semi-closed construction welded to closed box sections 40x27 [mm].

Maximum height of segments: 2.4 [m].

Can be installed to steel or brick posts.

MESH PANEL FENCES

WISNIOWSKI mesh panel systems are an excellent solution where durability, high quality, and safety are a priority.

Thanks to their functionality, appearance, and parameters, the mesh panel systems by WISNIOWSKI are a proven solution for any conditions. They can be used both in urban and industrial areas.

The mesh panel infill is a system solution for building a complete fence including a sliding or leaf gate with spans made of mesh panels and dedicated posts and accessories. Fences built this way have a harmonious appearance with consistent design.

WISNIOWSKI mesh panels are a high quality product. They are manufactured using state-of-the-art technology.

VEGA panels are welded using raw wire, then they are hot-dip galvanized or electrogalvanized and powder coated. Panels manufactured using this technology are characterized by reliable welds and elimination of possible corrosion centres.

We offer a 10-year warranty for the DUPLEX version.

Available in all RAL palette colours.



ANTI-CORROSIVENESS

VEGA 3D mesh panels for fences

VEGA B

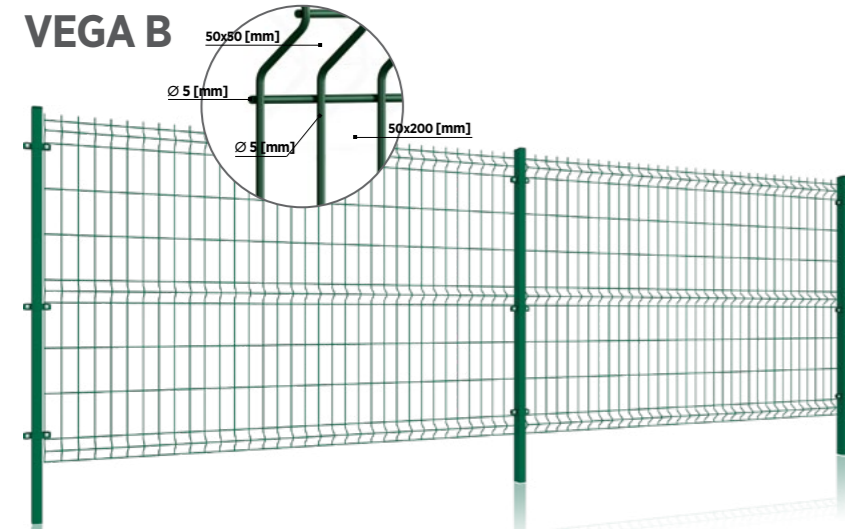

Panel width 2500 [mm]

Available panel heights

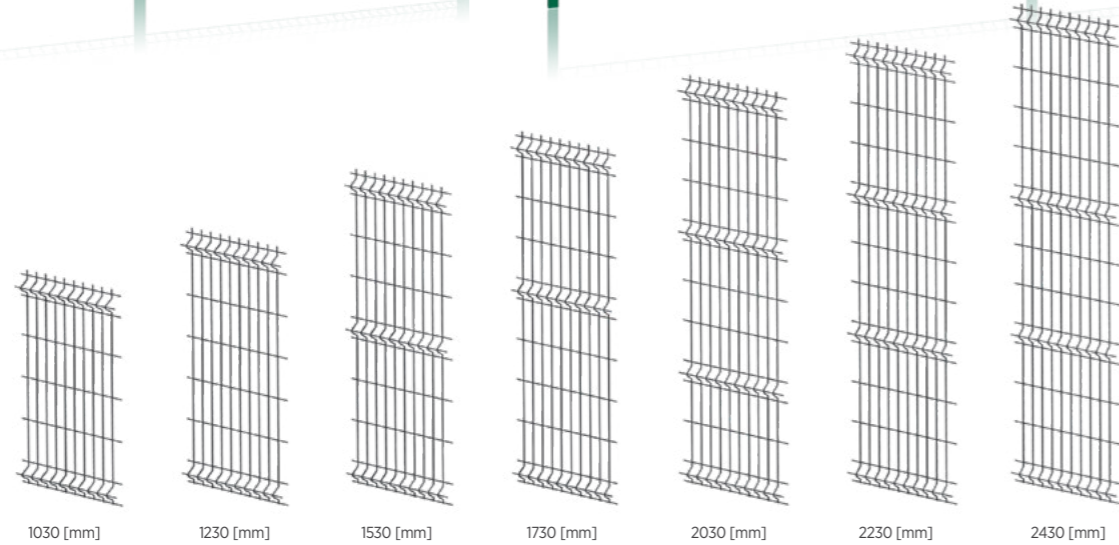

VEGA B Light

VEGA B

VEGA B Light

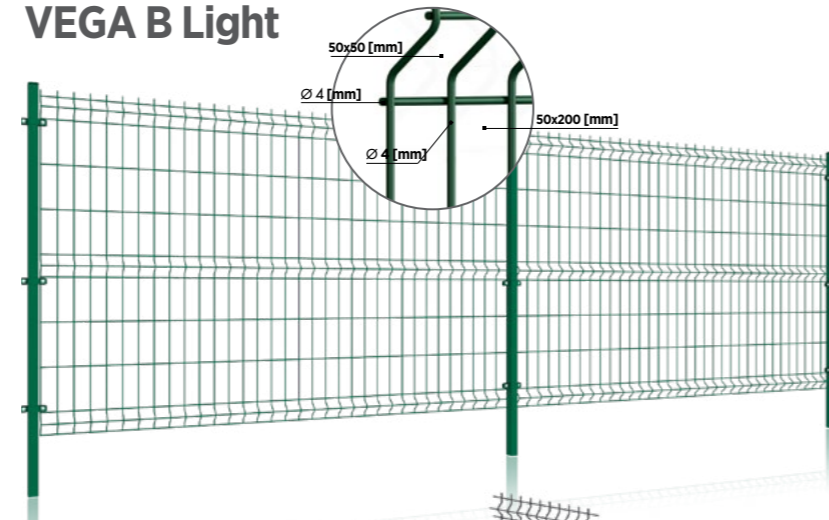

VEGA B 55x200



Available panel heights

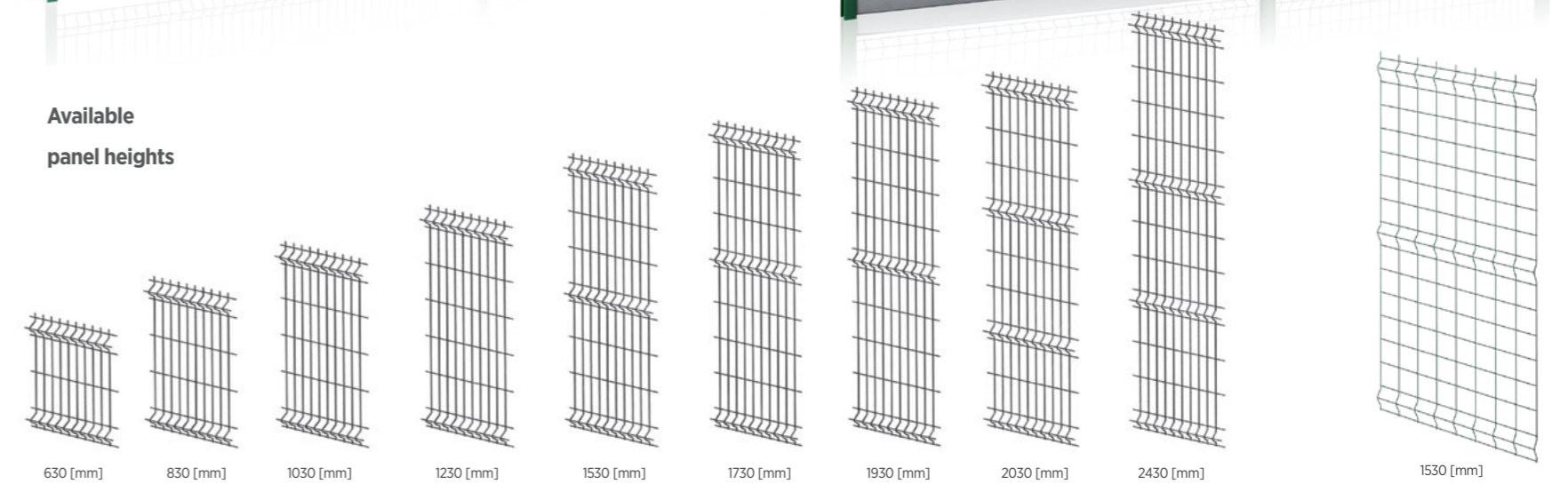

VEGA B 55x200

VEGA B Light II

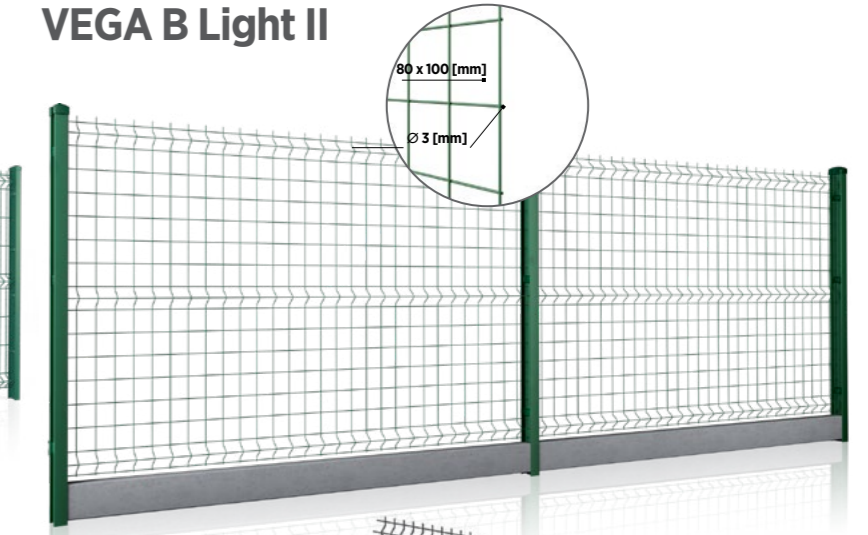

VEGA B Light II

VEGA 3D panel installation systems

The 3D mesh panel group is mounted using one of eight installation systems.

System availability for individual panel types

| | BETA | BETA Safe | BETA 48 | GAMMA |
|-----------------|------|-----------|---------|-------|
| VEGA B | ● | ● | ● | ● |
| VEGA B Light | ● | ● | ● | ● |
| VEGA B 55x200 | - | ● | - | ● |
| VEGA B Light II | - | - | - | ● |



BETA system

Post made of a 60x40x1.5 [mm] section, post h=3,200 [mm]

60x40x2 [mm].

The post is supplied with plastic caps and holes for easy installation. Installation is carried out with a hook screw.



BETA Safe system

Galvanized sheet profile post A proprietary solution by WISNIOWSKI. The post profile was designed to provide maximum safety to users (the nut is concealed in the profile recess of the post). The post is supplied with plastic caps and holes for easy installation. Installation is carried out with a hook screw.



BETA 48 system

Round post. Post diameter 48.3 [mm]. The post is supplied with a plastic cap and holes for easy installation. Installation is carried out with a hook screw.



GAMMA system

Galvanized sheet profile post coated with polyester paint. A proprietary solution by WISNIOWSKI. The post is supplied with plastic caps and holes for easy installation. Installation with screws and plastic clips.



OMEGA system

Post made of a 60x40x1.5 [mm] section, post h=3,200 [mm] 60x40x2 [mm]. The post is fitted with plastic caps. Installation with rectangular assembly clamps.

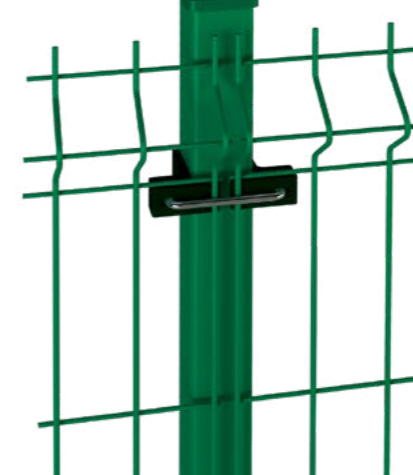

OMEGA D1 system

Post made of a 60x40x1.5 [mm] section, post h=3,200 [mm] 60x40x2 [mm]. The post is fitted with plastic caps. Installation with type D1 assembly clamps.

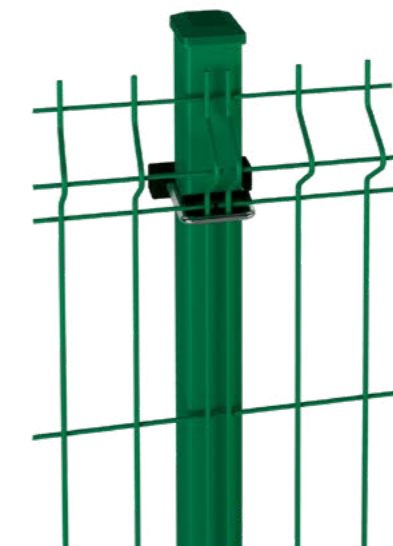

OMEGA D2 system

Post made of a 60x40x1.5 [mm] section, post h=3,200 [mm] 60x40x2 [mm]. The post is fitted with plastic caps. Installation with type D2 assembly clamps.



OMEGA 48 system

Round post. Post diameter 48.3 [mm]. The post is fitted with plastic caps. Installation with half-round assembly clamps.

System availability for individual panel types

| | OMEGA | OMEGA D1 | OMEGA D2 | OMEGA 48 |
|-----------------|-------|----------|----------|----------|
| VEGA B | ● | ● | ● | ● |
| VEGA B Light | ● | ● | ● | ● |
| VEGA B 55x200 | ● | ● | ● | - |
| VEGA B Light II | ● | - | - | ● |

VEGA 2D mesh panels for fences

VEGA 2D

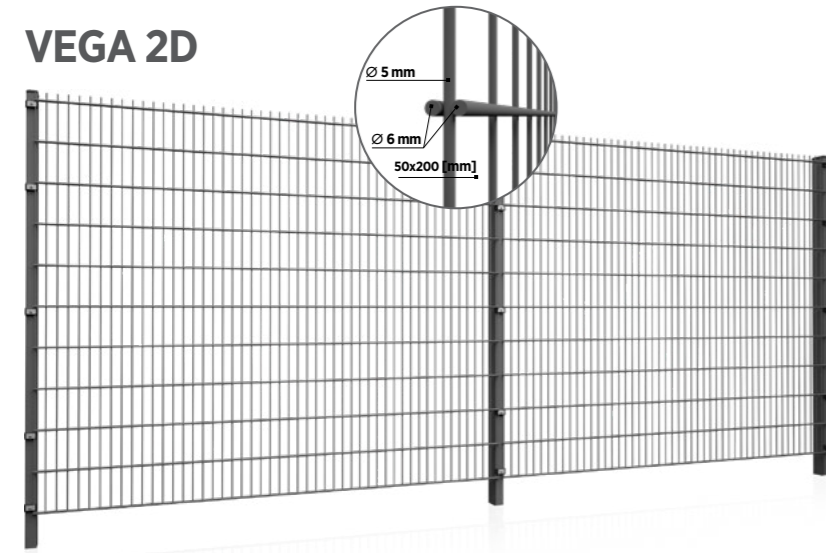

VEGA 2D Super

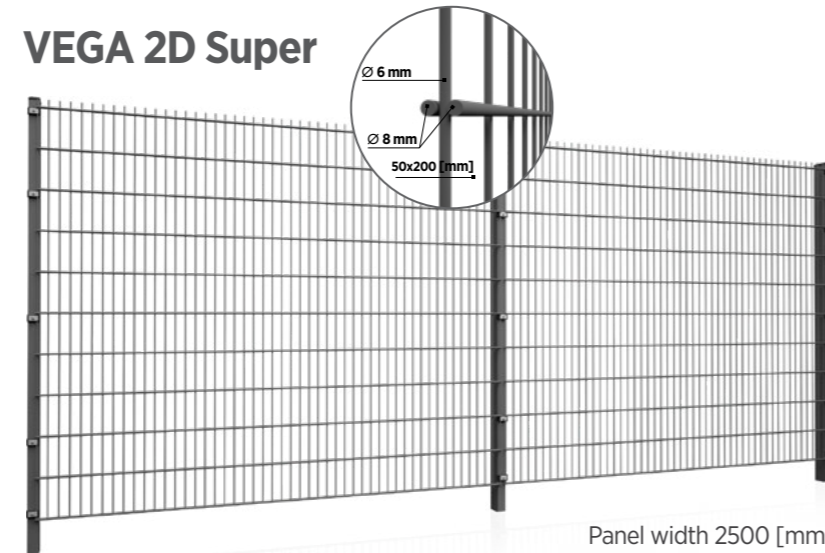

Panel width 2500 [mm]

Available
panel heights

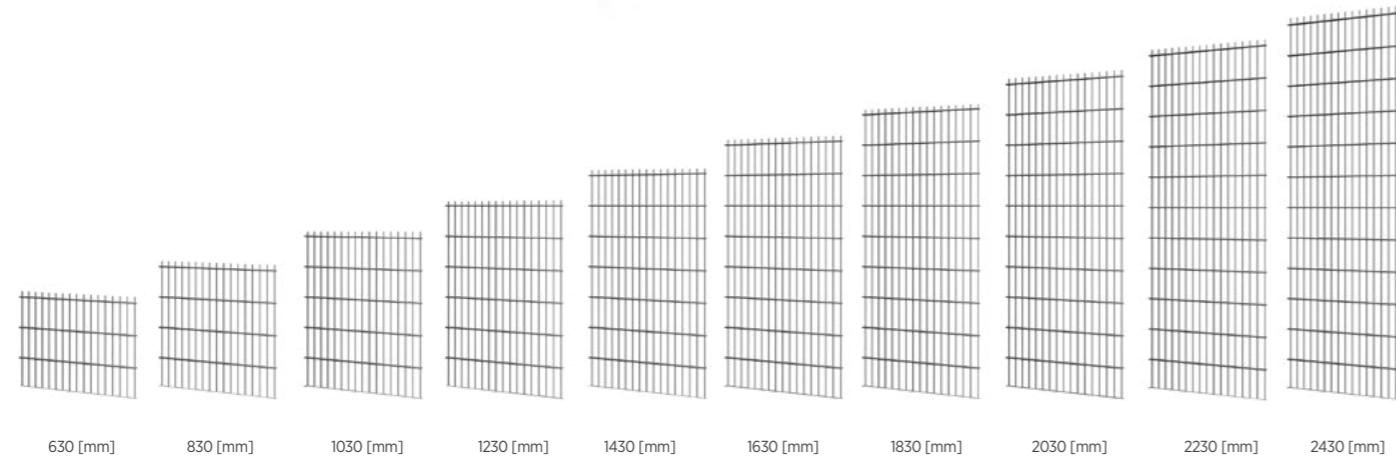

VEGA 2D | VEGA 2D Super

VEGA 2D panel installation systems



DELTA S system

Post made of 60x40x1.5 [mm] section, post h=3,200 mm 60x40x2 [mm]. The posts are supplied with a plastic cap and hooks for the panels with threaded holes for screws. Installation with screws and a clamping plate.



DELTA L system

Post made of a 60x40x1.5 [mm] section, post h=3,200 [mm] 60x40x2 [mm]. The posts are fitted with a plastic cap and an increased number of hooks for the panels with threaded holes for screws. Installation with a screw and a clamping plate.



SIGMA system

Post made of a 60x40x1.5 [mm] section, post h=3,200 [mm] 60x40x2 [mm]. The post is fitted with a plastic cap or an aluminium cap as an option and an increased number of hooks for the panels with threaded holes for screws. Installation with a screw and a clamping flat bar.



OMEGA system

Post made of a 60x40x1.5 [mm] section, post h=3,200 [mm] 60x40x2 [mm]. The post is fitted with a plastic cap.



OMEGA D1 system

Post made of a 60x40x1.5 [mm] section, post h=3,200 [mm] 60x40x2 [mm]. The post is fitted with a plastic cap.

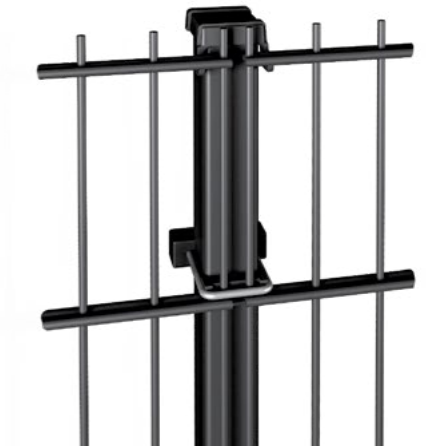

OMEGA D2 system

Post made of a 60x40x1.5 [mm] section, post h=3,200 [mm] 60x40x2 [mm]. The post is fitted with a plastic cap.

GABION Posts

Gabion systems were initially used as shore and river bank reinforcement. Gabions are used to create a strong structure that will stand the test of time.

They were adapted to harmonize with urban architecture, which opened new application opportunities.

They constitute modern and practical protection for residential and industrial areas. Their industrial character perfectly matches both the industrial and residential fence groups. Gabions are frequently installed in high-density urban areas, where due to their opaqueness and sound-absorbing characteristics, they form enclaves of privacy in a way. In open areas, they are also often used as wind barriers.

WISNIEWSKI gabion range includes two post types: posts based on the IPE 160 I-section and STM posts based on 50x100 or 50x120 [mm] box sections. Both types are compatible with VEGA 2D and VEGA 2D Super panels, as selected by the customer.

The crucial feature of the gabion system by WISNIEWSKI is its long-term reliability. The panels' and posts' treatment with hot-dip galvanizing or galvanizing and polyester coating effectively prevents corrosion processes.





GABION Posts

Gabion System with IPE 160

The gabion system includes VEGA 2D or VEGA 2D Super panels installed between IPE 160 gabion posts. The panels and gabion posts form a structure to be infilled with stone or other material in accordance with the intended use. The gabion posts are critical for the stability of the entire gabion fence structure. They are characterised by high resistance to deformation. The posts are fitted with hooks inside the recess where the panels are installed. The entire solution makes for a uniform fence line.

IPE gabion posts are protected by hot-dip galvanizing or hot-dip galvanizing and polyester coating.

Can be painted in any RAL palette colour. Up to 10 years of corrosion protection warranty for posts and mesh panels with the DUPLEX powder coating system.

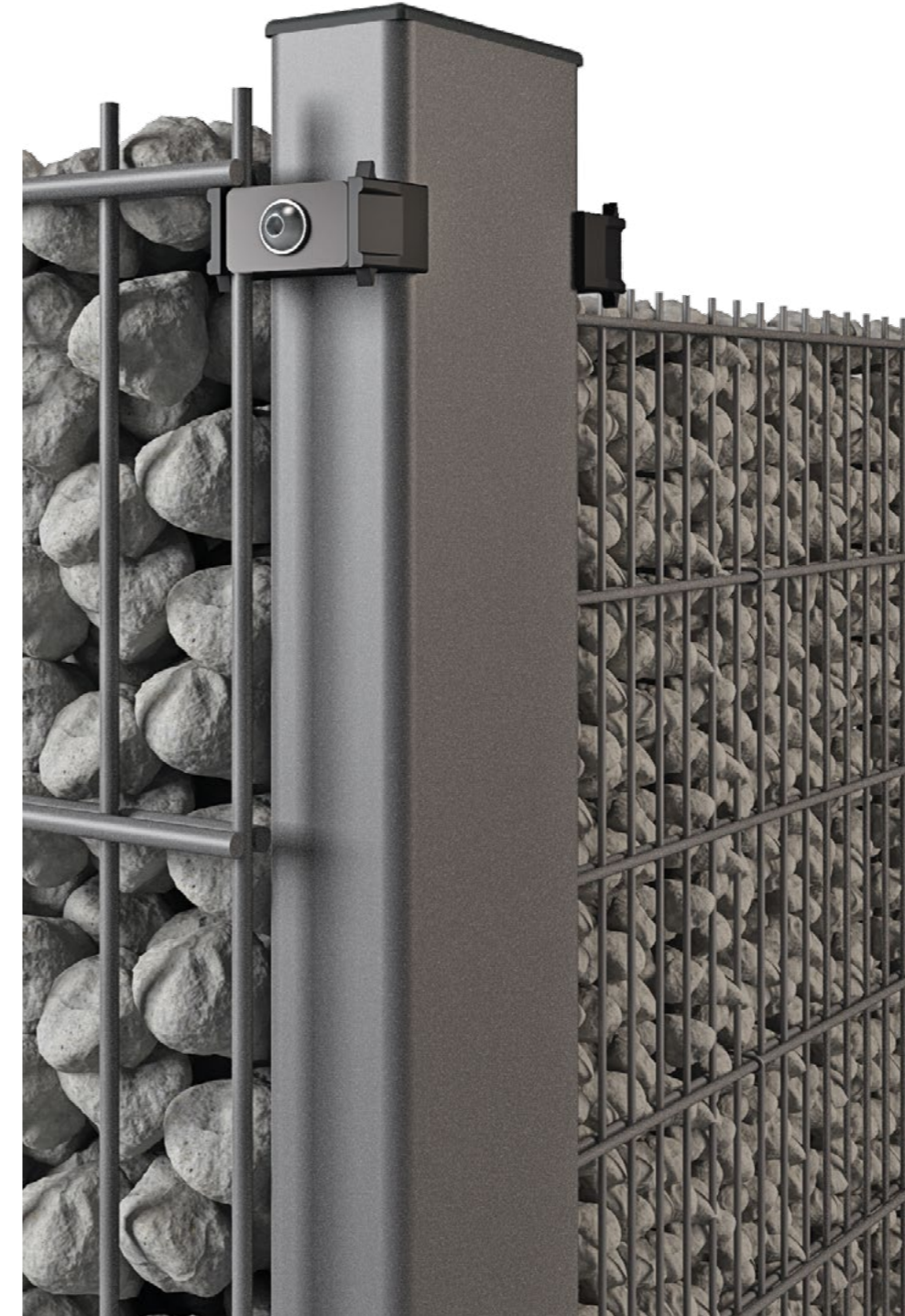

Gabion System with STM

The gabion system includes VEGA 2D or VEGA 2D Super panels. The panels are installed between STM gabion posts with a cross-section of 50x100x3 [mm] or 50x120x4 [mm].

The panels and gabion posts form a structure to be infilled with stone or other material in accordance with the intended use. The panels are installed to post hooks with the use of accessories. Clips preventing panel deformation are an obligatory accessory.

STM gabion posts are protected by hot-dip galvanizing or hot-dip galvanizing and polyester coating.

Can be painted in any RAL palette colour. Up to 10 years of corrosion protection warranty for posts and mesh panels with the DUPLEX powder coating system.

SPORT Fences

WISNIOWSKI sport fences are a proven solution tailored to the design needs and requirements. They are intended for fencing off courts, pitches, and fields for various disciplines: football stadiums, small sided football pitches, athletics stadiums, tennis courts, etc.

WISNIOWSKI sport fences are well-thought-out fence systems based on system solutions. The sport system includes industrial fence elements such as Vega 2D and VEGA B mesh panel groups, VEGA 2D Super Sport panels, sport posts with an increased cross-section and height, posts with ball stop accessories, and access control elements such as single- and double-leaf gates and wickets. Sport fences are available with heights ranging from 3 to 6 [m].

Can be painted in any RAL palette colour. Up to 10 years of corrosion protection warranty for posts and mesh panels with the DUPLEX powder coating system.



SAFETY



SPORT Fences

ProSport post

System-based posts especially recommended for football pitches and small sided football pitches, as well as tennis courts, handball and volleyball courts, and athletics stadiums.

The posts are designed for quick installation with the use of ProSport accessories.

ProSport accessories include plastic hooks which are used to mount the mesh panels and act as distance elements between the mesh panels and the posts. Fences made using ProSport posts have a lower tendency to resonate, which decreases the noise level around sports facilities.

ProSport posts are also available with ball stop accessories, which are particularly recommended for installation behind football goals.

The posts are available with the following cross-sections: 70x50, 80x50, 100x50 and 120x50 [mm] and height range from 3 to 6 [m].



VEGA 2D Super Sport

Hot-dip galvanizing or galvanizing and polyester coating.
Panels are spot welded using steel bars.
Horizontal wire (double) gauge: 2x8 [mm].
Vertical wire gauge: 6 [mm].
Straight mesh size 100x200 [mm].
Panel width within the axis of the outermost bars 2,500 [mm].
Terminated from the top with 30 [mm] long vertical wires.

Available in two dimensions: 1,030 and 2,030 [mm].

VEGA 2D Super

Hot-dip galvanizing or galvanizing and polyester coating.
Panels are spot welded using steel bars.
Horizontal wire (double) gauge: 2x8 [mm].
Vertical wire gauge: 6 [mm].
Straight mesh size 50x200 [mm].
Panel width within the axis of the outermost bars 2,500 [mm].
Terminated from the top with 30 [mm] long vertical wires.

See page 66 for available heights.

Portable solutions

A solution intended for the sector operating in the area of securing the perimeter of sites and premises for the time of construction, renovation, demolition, etc. Considered to be the most important access control elements, the gates were fitted with steel bases and concrete ballast that stabilize the entire structure without the need to prepare foundations or install anchors.



TRAFFIC



V-KING



PI 95



SYSTEM-BASED SOLUTION
PI 95 sliding gate and BASTION wicket combined with OPZ 252 industrial segments



A FENCE SYSTEM WITH A SHARP TOP EDGE
PI 95 sliding gate, BASTION double-leaf gate, and BASTION wicket. The whole set with a 25x25 section infill.



SYSTEM-BASED SOLUTION
Various infill designs can be combined. The V-KING folding gate with the 25x25 infill paired with the fence made of VEGA B panels with the BASTION wicket infilled with the VEGA B panel.

The sliding gate features a cantilever design. The gate does not touch the ground. The rail is much less prone to becoming packed with dirt or ice.

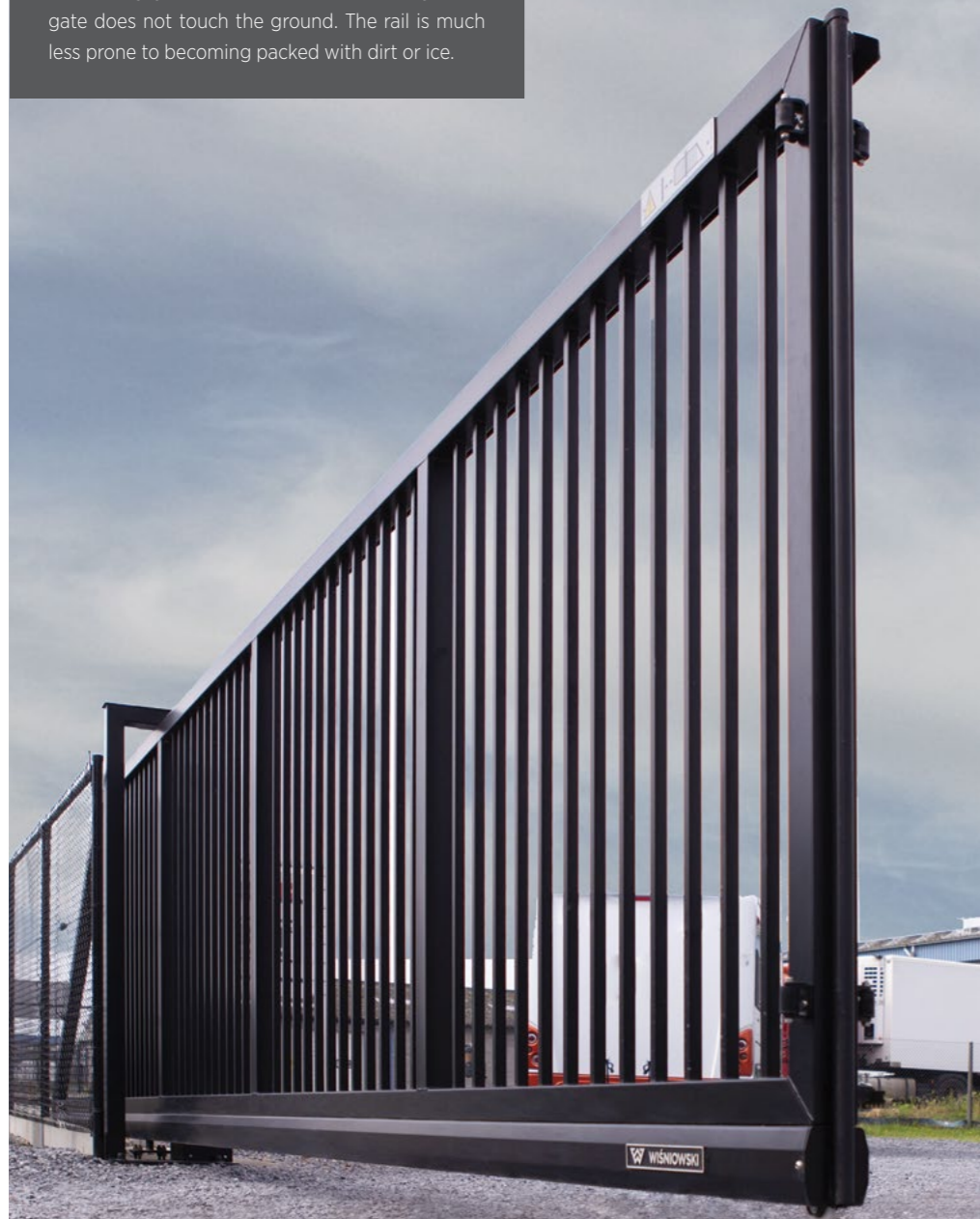

AUTOMATIC OPERATING UNIT ENCLOSED IN A BOX

A sliding gate with a high box is a perfect solution ensuring convenience of use. The automatic operating unit and the control system are enclosed in a box and thus protected from the adverse effects of the weather and from tampering by unauthorized persons.



SYSTEM-BASED SOLUTION
Posts with Y tops for barbed or razor wire, a comprehensive fence for strategic sites



SYSTEM-BASED SOLUTION

V-King gate with VEGA 2D Super mesh panel infill. VEGA 2D Super panels on the OMEGA post with a prefabricated foundation.



ACCESS CONTROL FOR WIDE CLEAR PASSAGES
The PI 200 sliding gate, manufactured up to the maximum width of 16m, is intended for closing off wide clear passages.



Sliding gate in the Totmann version. The gate is controlled with a key switch.



PRACTICAL USE OF MESH PANELS
The PI sliding gate combined with the VEGA mesh panel is a solution frequently used for fencing off larger sites.



Pump track fence.



Tennis court fence.

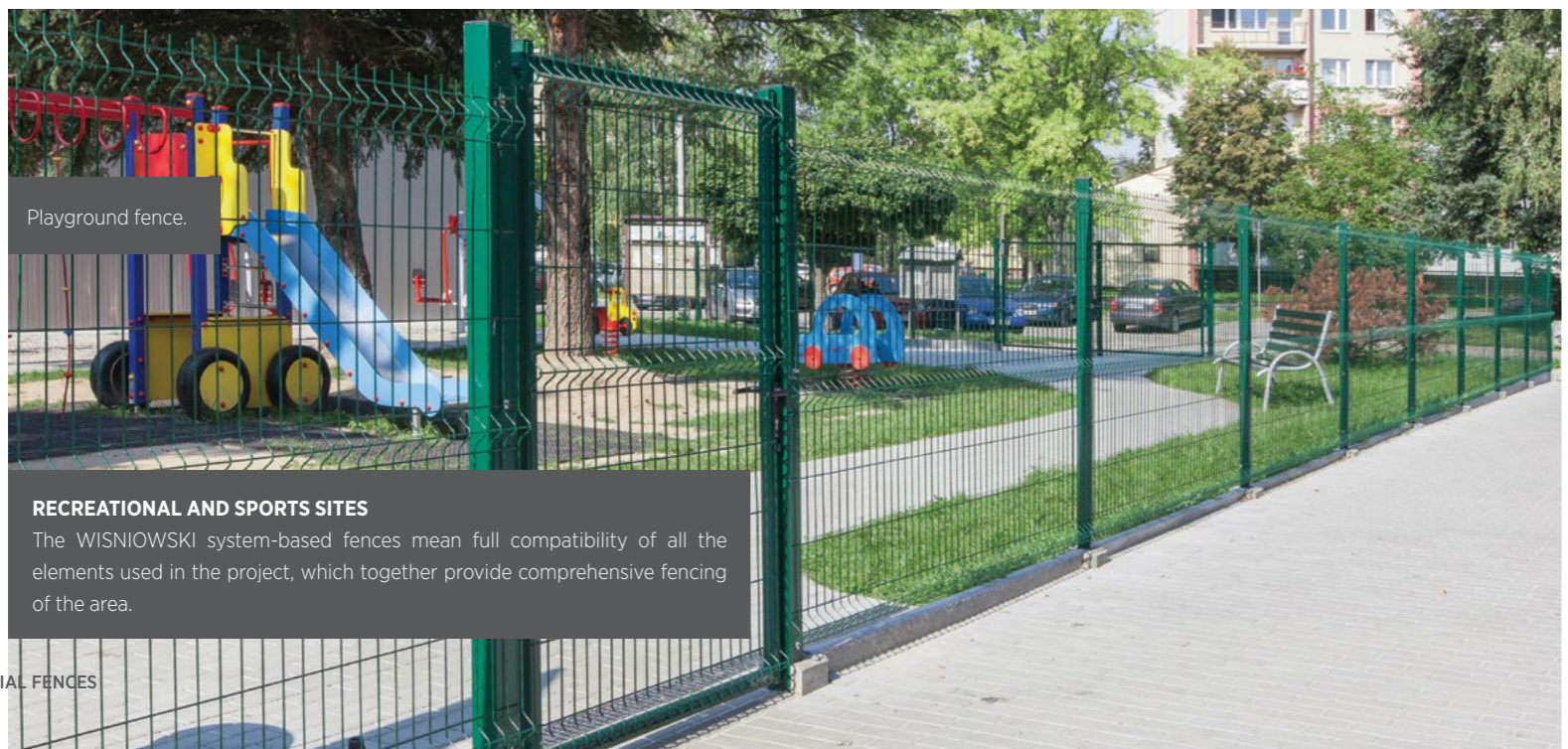

Playground fence.

RECREATIONAL AND SPORTS SITES

The WISNIOWSKI system-based fences mean full compatibility of all the elements used in the project, which together provide comprehensive fencing of the area.



Stadium fence.

MESH PANEL IN LINE WITH A RESIDENTIAL FENCE

A combination of decorative fence elements with mesh panels is an appealing solution for a robust fence. This combination is achieved thanks to modular elements that together make a perfectly matching fence system.

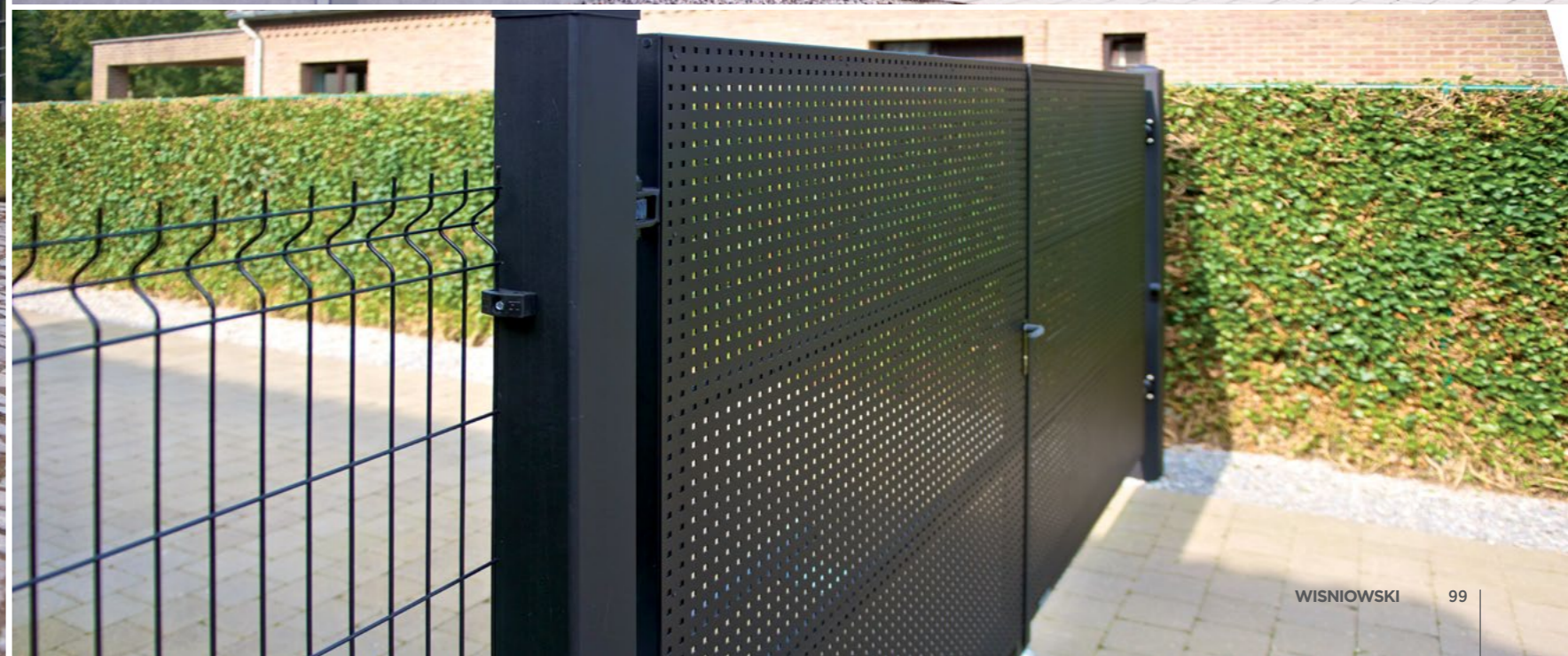



INTENDED USE OF THE PI SLIDING GATES
The sliding gate is usually installed in wide areas enabling free sliding.



Industrial gates are also used in agriculture.



CONVERGING GATES

Converging gates are a solution making it possible to close off clear passage widths of up to 24m.

Depending on the width, the converging gates are manufactured on the PI 95, PI 130 or PI200 track beam.





CUSTOM AND SPECIALIST SOLUTION
Two gates installed opposite each other closing off a 60 [m] opening to allow a plane with its full wing span to pass through.

WISNIOWSKI HALL INCLUSIVE

The WISNIOWSKI Hall Inclusive collection is a comprehensive range of industrial gates, doors, and fences designed with ergonomics, safety, durability, and reliability in mind. Innovative technological solutions are reflected by exceptional functionality that meets the highest requirements for the equipment for specialist facilities. The products enable high-capacity logistics and help the business operate smoothly.

The collection includes sectional, roller, and overhead doors, steel and aluminium joinery, panel fence systems, and more.



Industrial door
MakroPro 2.0

Seamless steel
door
Eco

Sliding gate
PI 200





WISNIOWSKI

GATES | WINDOWS | DOORS | FENCES



DISCOVER
MORE...



www.wisniowski.pl/en

The products shown in the photographic materials often feature special accessories and do not always match their standard finish. • This brochure does not constitute an offer within the meaning of the Polish Civil Code. • The manufacturer reserves the right to make changes • All rights reserved • Reproduction and use, even partial, is permitted only with the consent of WISNIOWSKI Sp. z o.o. S.K.A. • 08/20/EN