



WIŚNIEWSKI



PRIMO PVC windows

Why **WIŚNIEWSKI**?

For the last three decades, we have been working in accordance with the idea of the founder of the WIŚNIEWSKI brand, Andrzej Wiśniowski, who made it his goal to create innovative products addressing all of our customers' needs.

We want your home to be secure and comfortable. Taking advantage of our 30 years of experience in the production of garage doors, gates, windows, doors, and fences, we offer our customers top quality products. We know what a modern home needs and what challenges the household may face.

Currently, our production hall spanning 270,000 square metres manufactures thousands of garage doors, gates, windows, doors, and fences every day. At the same time, we are also able to customize the products to meet our customers' requirements.

Everyone has different needs and expectations, which is why when manufacturing our products, we focus on listening to what you have to say. Meet the WIŚNIEWSKI brand – enter the world of comfort and security.

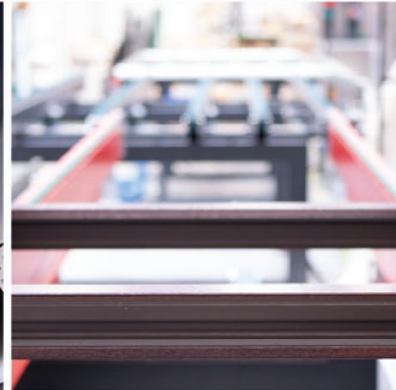



WIŚNIEWSKI. Gates, windows, doors, fences.

First of all..., **PRIMO** are windows designed for you.

For 30 years, WIŚNIOWSKI products have been part of millions of homes around the world. You have known us for years, you know the quality and uniform design of our products. But now, let us meet a step earlier. Let's start together with... WIŚNIOWSKI WINDOWS.

We designed exceptional PVC windows from the best VEKA profiles in class A, with the Maco hardware and the V-Perfect seam which is barely noticeable to the human eye. We created them, because with 30 years of experience in window manufacture, we truly understand what you need. Do your dreams reach further? We will be happy to hear you out, because with the achievements of Industry 4.0, we can manufacture products made to measure especially for you, exactly to your dimensions. Look no further – trust our original concept of garage doors, windows, doors, gates, and fences in uniform design. Our windows meet the highest technical requirements. But numbers are not everything. Your peace of mind and time matter, too.

Guarantee yourself a peace of mind for many years to come and order all that you need from a single manufacturer. Order windows, doors, garage door, gate, and fence during the same trip to our partner showroom. Take advantage of great financing options in our instalment plan.



Discover 10 reasons to choose WIŚNIEWSKI PVC windows

1.

All of WIŚNIEWSKI PVC windows are designed and made of the best VEKA class A profiles with the Maco hardware

2.

Leading edge invisible effect V-Perfect profile joint – a joint which is barely noticeable to the human eye

3.

Hook drive gear in the HST patio door as standard

4.

A complete joinery set from a single manufacturer – a set of WIŚNIEWSKI PVC windows, garage door, door, gate, and fence with matching design and features

5.

16 original structural colours with a 3D metallic effect in the Home Inclusive 2.0 collection

6.

Through-coloured profiles and gaskets in three colours ensure a perfect visual effect

7.

Seven-year guarantee for PVC windows – for your peace of mind and confidence

8.

Almost 30 years of WIŚNIEWSKI's experience in manufacturing challenging aluminium windows

9.

High-quality windows, made on our cutting edge automated production lines

10.

Unlimited customization – create your own WIŚNIEWSKI PVC window that is made to measure to suit your needs

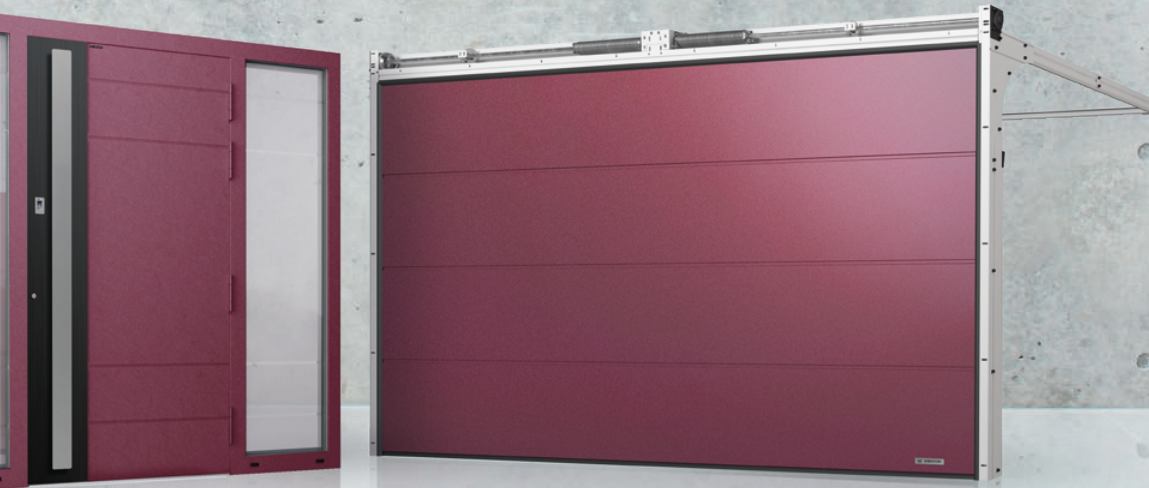



Welcome to the world of **WIŚNIEWSKI windows**

Window connect you to the outside world, but they also let you isolate from it. So they have to combine contradictory functions and features.

Designing the perfect window – that isolates and connects at the same time – is a considerable challenge that can only be met by the best of manufacturers.

The WIŚNIEWSKI brand manufactures windows that guarantee safety, security and comfort, privacy and proper interior lighting, aesthetic qualities and perfect thermal parameters. They will isolate you from the cold and noise, but they will allow the sun to brighten your home's interior.

Windows are one of the most important elements of each building.

That is why we want to provide you with the opportunity to order windows that will not only match your home's design, but also your expectations – and not just the visual ones. You will not have to choose between the visual appeal, safety and security or comfort.

Discover the world of WIŚNIEWSKI windows with us. It is a journey filled with inspiration, great advice, and the best design.



BURGLAR PROTECTION

SAFETY

Unwelcome guests? Not in a house furnished with the PRIMO windows by WIŚNIEWSKI. Their precision-made structure ensures burglary resistance



THERMAL INSULATION

THERMAL INSULATION

The thermal transmittance factor of the entire window from 0.76 W/m²K for the PRIMO 82 windows. The values apply to single-leaf windows sized 1,480 x 1,600 mm.



SOUND ABSORPTION

SOUND INSULATION

Nothing will disturb the moments you share with your family. WIŚNIEWSKI's PRIMO windows ensure acoustic comfort by reducing the level of noise from the outside.



RIGIDITY

RIGIDITY

WIŚNIEWSKI windows are an investment that stands the test of time. Top of the line materials and perfect manufacturing ensure reliable operation in all kinds of conditions.



DESIGN

DESIGN

We guarantee elegant and modern design of our windows that you are free to customize thanks to the Home Inclusive 2.0collection



LUXURY CLASS

LUXURY CLASS

Our windows offer unique design, high quality manufacturing, safety, security and durability, all as standard! It places them among products of the highest class in this segment.



WARRANTY

WARRANTY

PRIMO windows by WIŚNIEWSKI are covered by a 7-year warranty. This is just to be on the safe side, but we want you to know that you can count on us.



CLASS A

ONLY CLASS A

PRIMO windows by WIŚNIEWSKI are designed and manufactured using the VEKA panels which according to PN-EN 12608 are classified as the HIGHEST class A.

PRIMO.

PVC windows.

PRIMO windows will surprise you with simplicity that places functionality and design first. When creating WIŚNIEWSKI windows, our designers and engineers primarily thought about what each home needs. We know how important the sense of security and reliability is. It remained our priority throughout the long process of designing the PRIMO windows. All the functional advantages of our PVC windows are highlighted by their state-of-the-art design, the simplicity and elegance of which will be a joy to look at for many years to come. PRIMO is the result of three decades of experience and efforts to create perfect windows.





PRIMO. The home is your castle.

Your home is your castle. Each element which connects its interior with the environment should, above all, provide resistance. Windows could be said to be just transparent walls. So they have to combine openness to the external world with effective protection from it.



BURGLARY PROTECTION





PRIMO.

Warm, warmer...

Let's talk about the perfect home. Its most important features certainly will include "warmth". And this is not just about the cosy, family atmosphere. "Warmth" should also be understood literally. Good windows guarantee more than just proper temperature inside. They also translate into notable savings on heating.



THERMAL INSULATION

The thermal transmittance factor of the entire window from 0.76 W/m²K for the PRIMO 82 window sized 1,480 x 1,600 mm.





PRIMO.

Peace and quiet.

After an entire day of commotion, stress and hurry – you are finally back home. You leave the whole world outside and focus on yourself and your family. When you take care of your loved ones, WIŚNIEWSKI windows make sure nothing else will bother you. This is possible with an innovative technology supported by decades of experience.



SOUND ABSORPTION





PRIMO. Strength thanks to the synergy of knowledge and experience.

The PRIMO PVC windows are a new addition to the WIŚNIOWSKI product portfolio. When designing them, we turned to our knowledge and experience in creating products of the highest quality, which ensure exceptional comfort of use and timeless design. And we got the support of innovative technologies, such as the V-Perfect invisible seam and original solutions from component suppliers: Veka and Maco. We have been manufacturing joinery products – which become part of many buildings and highlight their unique character on a regular basis – for almost 30 years. What pleases us most is that with our knowledge and experience, we are able to help you create the home of your dreams.

Drawing on our experience as a manufacturer of a broad range of products, our entire PVC window manufacturing process takes place under a roof, including raw material and finished product storage. This allows us to guarantee the highest quality of our products.



The technology of tomorrow – **V-Perfect**

We pay a great deal of attention to functionality, but also to the appearance of our products, which is why we weld PVC windows in a way that results in a barely noticeable joint. This makes it possible to obtain the effect of a perfect bond, which cannot be achieved using any other technology.



4 colours of profiles

The PRIMO window design is based on minimalism and attention to detail. The profile cores of the PRIMO windows are through-coloured in 4 colours. Depending on the window type, we provide profiles in: anthracite, brown, caramel, and white.

Additionally, in the case of the PRIMO 70 window with colour on one side, the following profile colours are available: white-caramel, white-brown, and white. This is all to minimize the risk of scratches on the film coated windows.

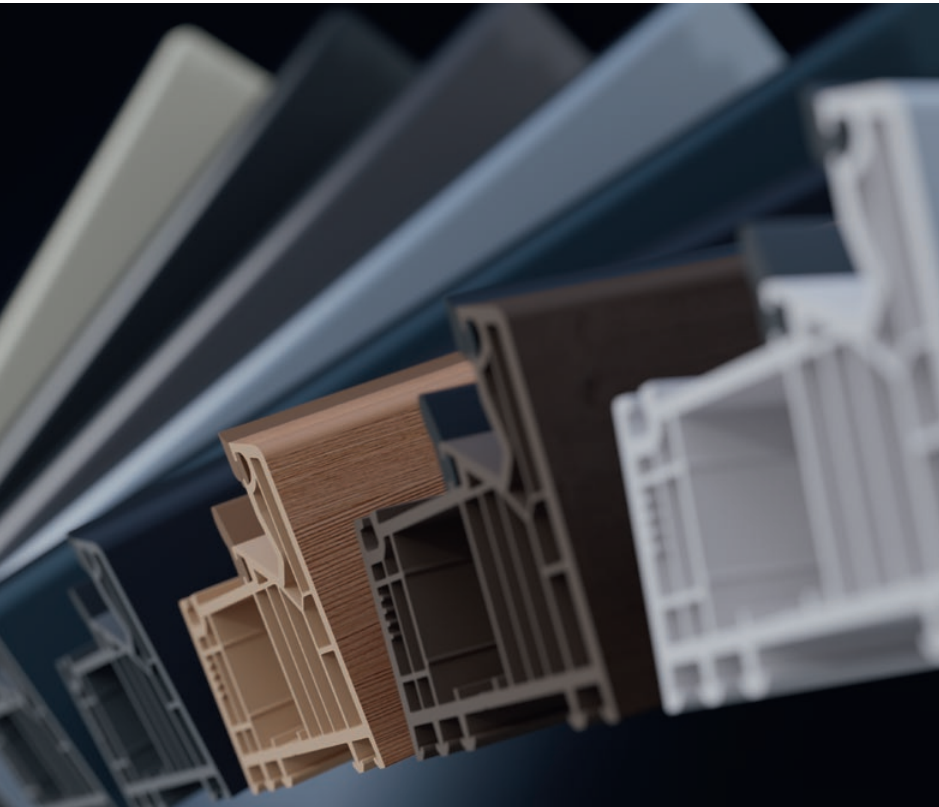

Unique finish and colours

The versatility of PVC windows does not rule out their exceptional character. Aluminium cover plates provide them with an individual, customized look. A broad range of colours makes it possible to match the window design to the building, and the modern powder coating technology used on aluminium cover plates ensures the durability everyone seeks. Additionally, by using structural colours from the Home Inclusive 2.0 collection, you can lend a unique character to your PVC windows and patio door.

The extensive range of colours is complemented by bonded gaskets in colours matching the selected film coating – black, grey or caramel.



Discover our **PVC windows**

PRIMO 82 | PRIMO 76 | PRIMO 70

- 1 Class A windows** with advanced thermal insulation parameters, 82 mm, 76 mm or 70 mm installation depth and 7- or 5- chamber frames;
- 2 Windows in HI 2.0 colours** are available in a version with an aluminium cover plate;
- 3 Through-coloured window profile** in colours (anthracite, brown, caramel, and white) matched to the film coating colour;
- 4 Maco MultiMatic hardware** – comprehensive standard accessories guarantee safety and high comfort of use. The product can be complemented with additional options, such as SecuAir and concealed hinges;
- 5 Single- and double-chamber glass units** with perfect thermal insulation properties, optionally with a warm edge available in 6 colours;
- 6 A broad range of aluminium handle colours as standard.** Versions with a key and locking button, Secustic and SecuForte handles, as well as balcony door pulls are available as optional accessories;
- 7 Low aluminium threshold in balcony doors,** available together with concealed hinges and with the RC anti-burglary class;
- 8 Additional anti-burglary strikers** as standard on the faceplate drive gear;
- 9 The V-Perfect invisible seam as standard,** barely noticeable to the human eye;
- 10 Extruded gaskets** available in 3 colours (grey, black, caramel);

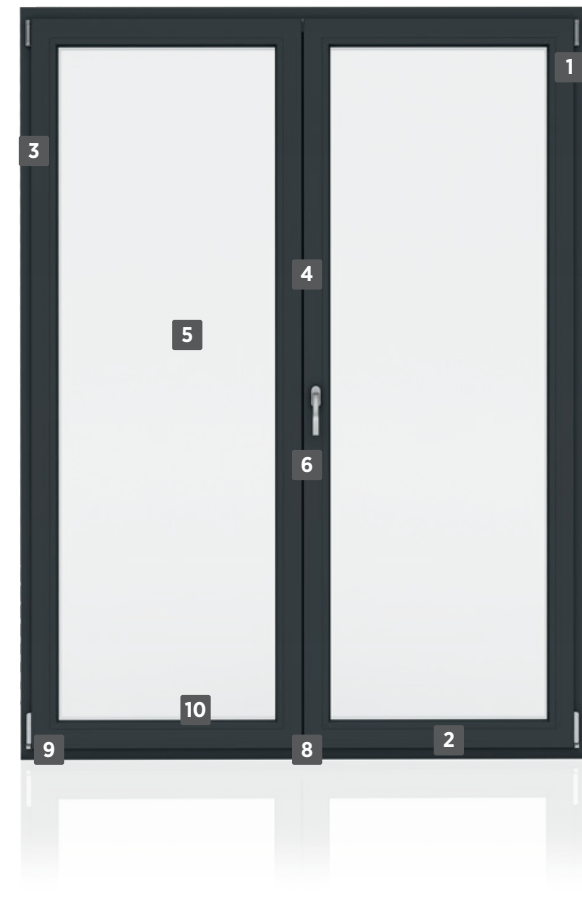
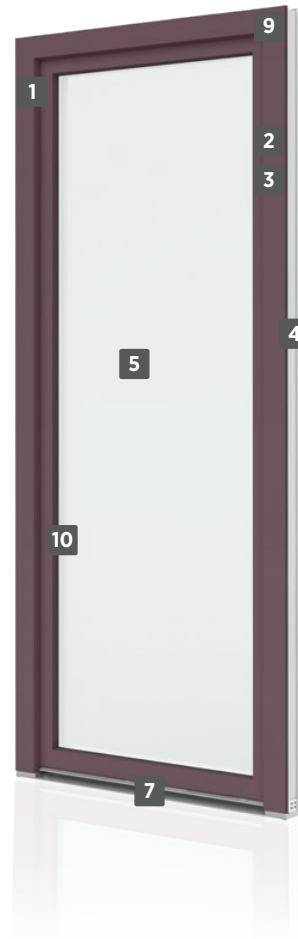

Discover our **PVC patio door**

PRIMO PSK | **PRIMO HST**

- 1** **Class A patio door** with advanced thermal insulation parameters;
- 2** **7- or 5-chamber patio door frame**, depending on the profile system;
- 3** **PSK hardware** – available as tilt and slide standard and automatic, as well as PAS parallel-stop-slide;
- 4** **HST hardware** – lift and slide with a hook drive gear as standard, ensures stability and smooth leaf operation up to 3 m of width, the RC version available for both options;
- 5** **Through-coloured window profile** matched to the film coating colour;
- 6** **The V-Perfect invisible seam as standard**, barely noticeable to the human eye;
- 7** **Available with an aluminium cover plate** in the Home Inclusive 2.0 colours;



PVC WINDOW SERIES

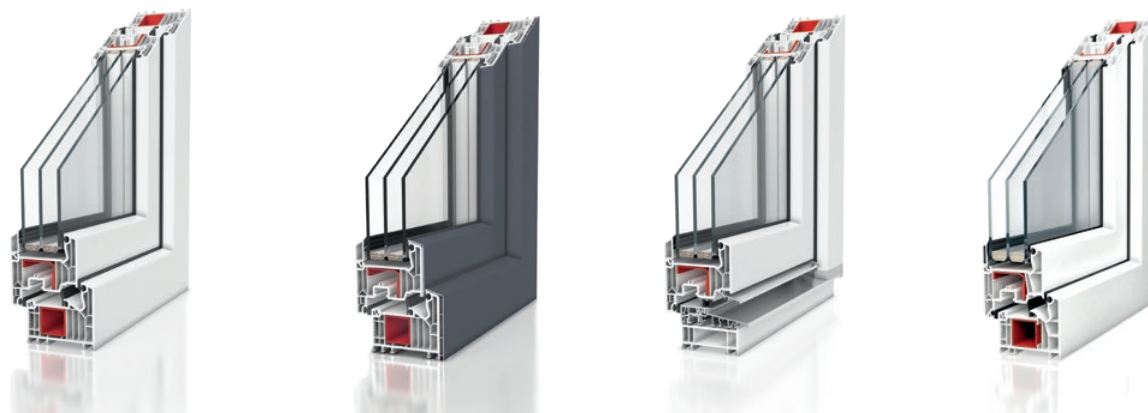

Window type		PRIMO 82	PRIMO 82-ALU	PRIMO 82 with a low threshold	PRIMO 76
Number of chambers in the frame		7	7	7	5
Installation depth		82 mm	87 mm	82 mm	76 mm
Profile class		A	A	A	A
Profile core		white, caramel, brown, anthracite	white, caramel, brown, anthracite	white, caramel, brown, anthracite	white, caramel, brown, anthracite
Gaskets around the circumference		3	3	3	3
Structural reinforcement		steel box section in the frame	steel box section in the frame	steel box section in the frame	steel box section in the frame
Standard glass unit		two-chamber 4/18/4/18/4 Ug=0,5 W/m²K	two-chamber 4/18/4/18/4 Ug=0,5 W/m²K	two-chamber 4/18/4/18/4 Ug=0,5 W/m²K	two-chamber 4/18/4/18/4 Ug=0,5 W/m²K
Standard hardware	Drive gear with a lifting mishandling device and a leaf lifter	●	●	●	●
	Moving rollers i.S.	●	●	●	●
	Alloy catches, one anti-burglary catch in the RU leaf	●	●	●	●
	Microventilation in scissor stay	●	●	●	●
	Surface hinges with pressure adjustment	●	●	●	●
	Bottom striker plate in the RU leaves	●	●	●	●
	Anti draught lock in RU	●	●	●	●
	Balcony catch in the balcony window	●	●	●	●
	Aluminium threshold with a 30 mm widening	—	—	●	—
Handle	aluminium	aluminium	aluminium	aluminium	
Security	SECURITY 1, SECURITY 2, RC2	SECURITY 1, SECURITY 2, RC2	SECURITY 1, SECURITY 2, RC2	SECURITY 1, SECURITY 2, RC2	

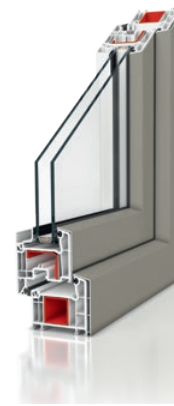

PRIMO 76 with a low threshold	PRIMO 70 CLASSIC	PRIMO 70	PRIMO 70-ALU	PRIMO 70 with a low threshold
5	5	5	5	5
76 mm	70 mm	70 mm	75 mm	70 mm
A	A	A	A	A
white, caramel, brown, anthracite	white, caramel, brown	white, caramel, brown	white, caramel, brown	white, caramel, brown
3	2	2	2	2
steel box section in the frame	steel box section in the frame	steel box section in the frame	steel box section in the frame	steel box section in the frame
two-chamber 4/18/4/18/4 Ug=0,5 W/m²K	jednokomorowy 4/16/4 Ug=1,1 W/m²K	jednokomorowy 4/16/4 Ug=1,1 W/m²K	single-chamber 4/16/4 Ug=1,1 W/m²K	single-chamber 4/16/4 Ug=1,1 W/m²K
●	●	●	●	●
●	●	●	●	●
●	●	●	●	●
●	●	●	●	●
●	●	●	●	●
●	●	●	●	●
●	●	●	●	●
●	●	●	●	●
●	—	—	—	●
aluminium	aluminium	aluminium	aluminium	aluminium
SECURITY 1, SECURITY 2, RC2	SECURITY 1, SECURITY 2, RC2	SECURITY 1, SECURITY 2, RC2	SECURITY 1, SECURITY 2, RC2	SECURITY 1, SECURITY 2, RC2

PVC PATIO DOOR SERIES



Window type	PRIMO PSK-82	PRIMO PSK-76	PRIMO PSK-70 CLASSIC	PRIMO PSK-70	PRIMO HST-82
Number of chambers in the frame	7	5	5	5	7
Profile thickness	82 mm	76 mm	70 mm	70 mm	82 mm
Gaskets around the circumference	3	3	2	2	2
Structural reinforcement	steel box section in the frame	steel box section in the frame	steel box section in the frame	steel box section in the frame	aluminium in frame
Standard glass unit	two-chamber 4/18/4/18/4 Ug=0,5 W/m ² K	two-chamber 4/18/4/18/4 Ug=0,5 W/m ² K	single-chamber 4/16/4 Ug=1,0 W/m ² K	single-chamber 4/16/4 Ug=1,0 W/m ² K	two-chamber 4/18/4/18/4 Ug=0,5 W/m ² K
Hardware	tilt and slide, parallel-stop-slide	tilt and slide, parallel-stop-slide	tilt and slide, parallel-stop-slide	tilt and slide, parallel-stop-slide	lift and slide, hook drive gear
Widening 30 mm	—	—	—	—	●
Security	PSK Standard and PAS - SECURITY 2	PSK Standard and PAS - SECURITY 2	PSK Standard and PAS - SECURITY 2	PSK Standard and PAS - SECURITY 2	SECURITY 2, Scheme A and C
Handle	aluminium	aluminium	aluminium	aluminium	aluminium

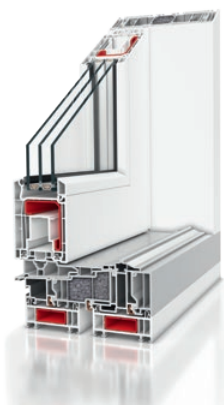

PRIMO HST-70

7

70 mm

2

aluminium in frame

two-chamber 4/12/4/12/4
 $U_g=0,7 \text{ W/m}^2\text{K}$

lift and slide,
hook drive gear



SECURITY 2, Scheme A and C

aluminium

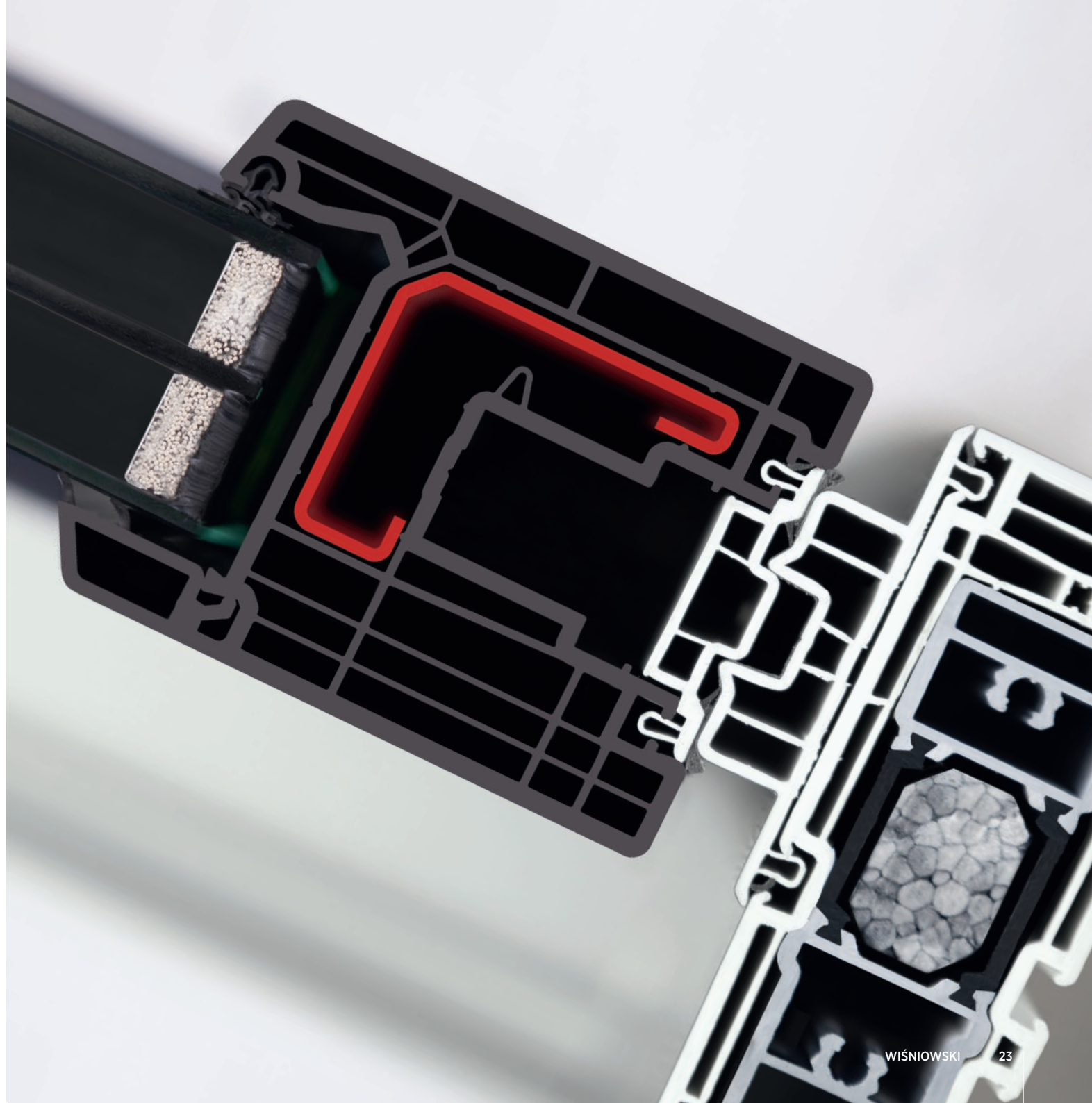

ACCESSORIES

standard accessories



Drive gear with a handle rotation lock and a leaf lifter



All i.S. moving rollers



Alloy strikers

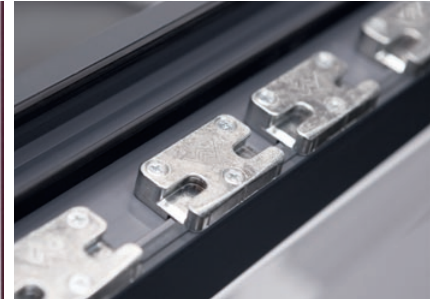

Anti-burglary striker plate in the RU leaf



Bottom striker plate in RU leafs



Microventilation in scissor stay



Surface hinges with pressure adjustment



Anti-draught lock in the RU leaf



Hook drive gear in the HST patio door

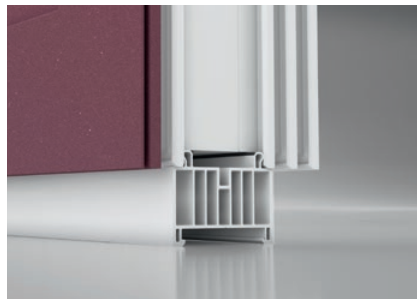

Transport and installation bar



Infilled bottom groove



Balcony catch with a handle in balcony windows

ACCESSORIES

optional accessories



Multi power (concealed hinge)



Multi secuair (vent unlocking)



Opening restriction



Wireless contact switch



Brake stay



Turn restrictor controlled with a handle



Safety pin device



Komfort drive gear



Surface-mounted wired contact switch



Flush-mounted wired contact switch



PSK hardware

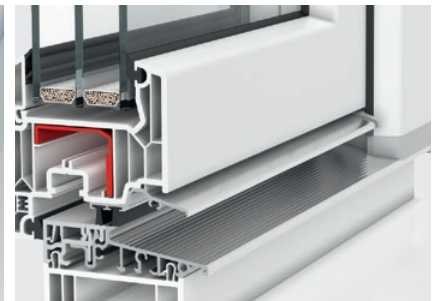

Low aluminium threshold

ACCESSORIES

optional accessories



Aluminium cover plate

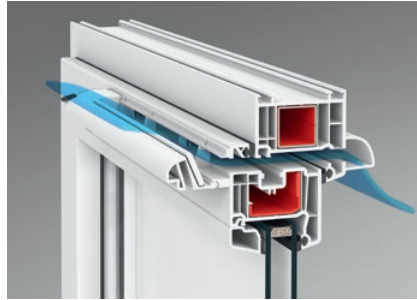

Aereco EMM humidity sensitive air inlet

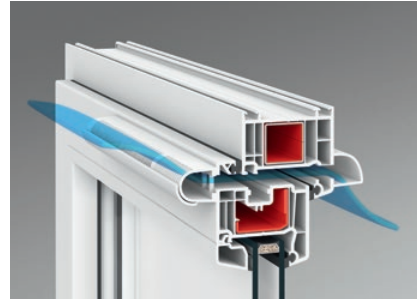

Aereco EMM pressure sensitive air inlet

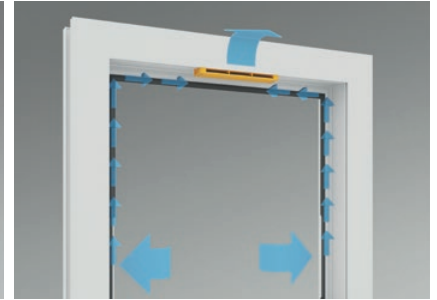

MACO Vent window rebate valve

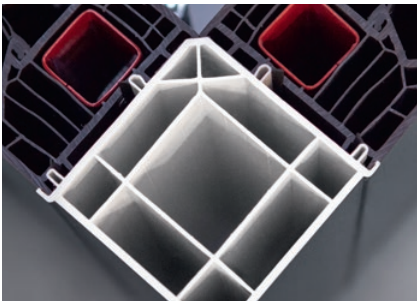

Coupling profiles



Warm edges



Glazing bars



Low threshold in HS



Tilt first



Thermo undersill strip



Thermal widening



Widening system



HANDLE COLLECTION





BASIC

available colours:

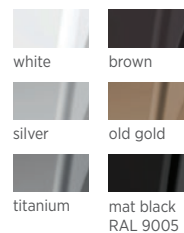

BASIC K with a key lock

available colours:

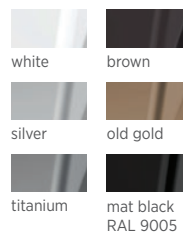

BASIC P with a locking button

available colours:

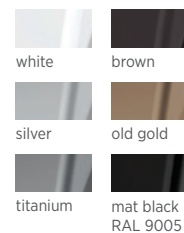

ROUND

available colours:

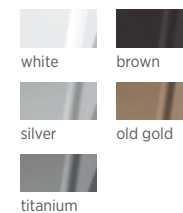

BASIC double-sided balcony



available colours:

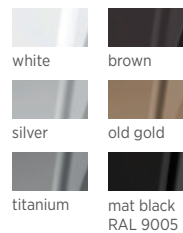

BASIC double-sided flat under roller shutter



available colours:

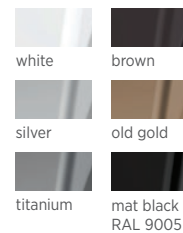

ROUND K with a key lock

available colours:

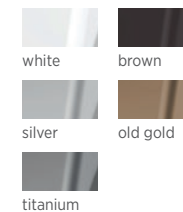

HANDLE COLLECTION



CUBE

available colours:

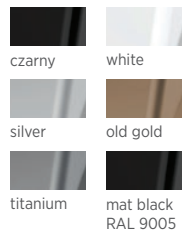

CUBE K
with a key lock

available colours:

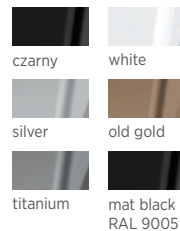

CUBE P
with a locking button

available colours:

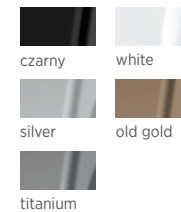

**Hoppe Hamburg
SecuForte**

available colours:

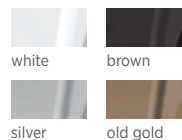

**Hoppe Toulon
Secustic**

available colours:

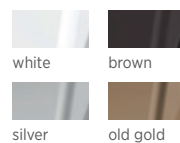

**Hoppe Toulon
Secustic**
with a key lock
100 Nm

available colours:

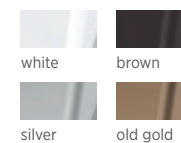



Hoppe Luxembourg Secustic

available colours:

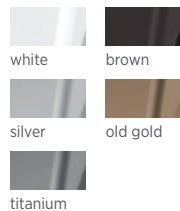

Hoppe Luxembourg Secustic
with a key lock
100 Nm

available colours:

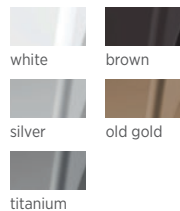

PSK-S and PSK-Pas handle
with a key



available colours:

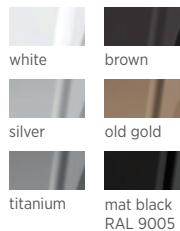

Handle PSK-S and PSK-Pas
double-sided



available colours:

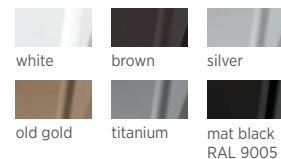

Handle PSK-S and PSK-Pas
double-sided under roller shutter



available colours:

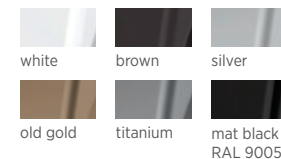

HANDLE COLLECTION



PSK-S and PSK-PAS



PSK-Z



PSK-Z
with a key lock



available colours:

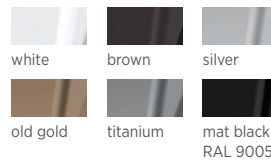

available colours:

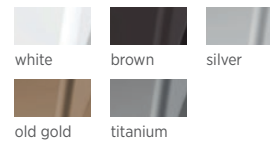

HST handle



available colours:

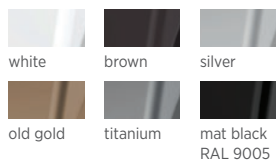

HST handle with a lock cylinder from the inside



available colours:

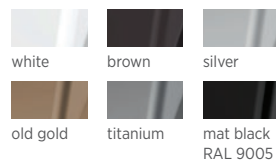

HST double-sided handle with a lock cylinder



available colours:

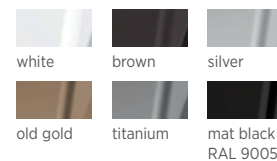

A feast of **colours**

A perfect home is a dream come true and brings to life everything that you have been creating in your imagination for years. Expectations vary, so we follow your imagination and we want to help you implement all your plans and ideas. Dreaming about a distinctive window colour? We are here to help. Choose from a broad range of colours and film coatings from our swatches or pick the unique Home Inclusive 2.0 collection that will make your home even more beautiful – it is available with PVC windows with an aluminium cover plate. Perhaps you would prefer for the window colour outside to differ from the colour inside? Choose the bicolour option and create your individual colour composition to match both your interior and façade design. Fulfil your dreams and be bold about it.



RAL palette colours, Veka Spectral, Decor and film coatings.

PRIMO WINDOWS – standard colours

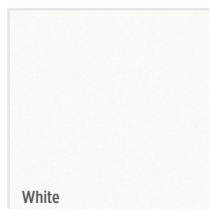

FILM COATINGS

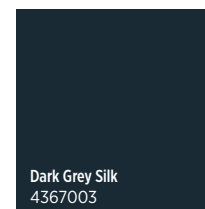
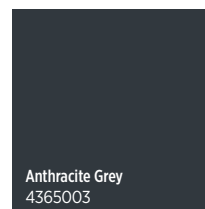
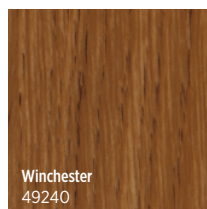
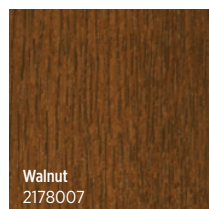
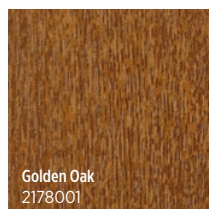

VEKA SPECTRAL – special colours

(dedicated) for PRIMO 76 and PRIMO 82

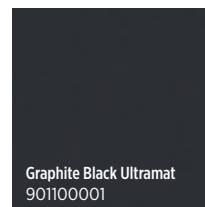
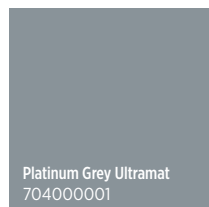
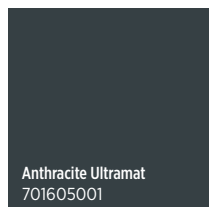

Due to technical reasons, actual colours may differ from those in the pictures and photographs. Please consult the dealer upon purchase.

PRIMO – film coatings, special colours



Due to technical reasons, actual colours may differ from those in the pictures and photographs. Please consult the dealer upon purchase.

PRIMO – film coatings, special colours



Due to technical reasons, actual colours may differ from those in the pictures and photographs. Please consult the dealer upon purchase.

HOME INCLUSIVE 2.0 colours

HEARTH

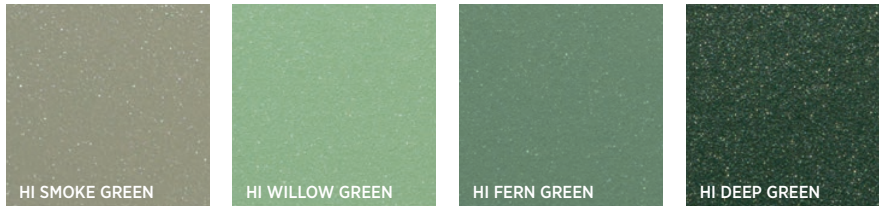

HISTONE

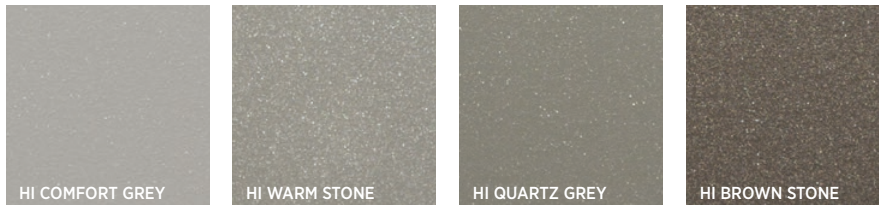

HISTEEL

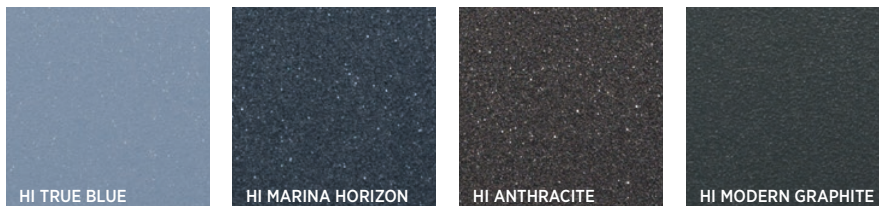

HIRUBY



HOME INCLUSIVE 2.0 colours are available for the PRIMO 70 and PRIMO 82 windows with an aluminium cover plate. Due to technical reasons, actual colours may differ from those in the pictures and photographs. Please consult the dealer upon purchase.



The Home Inclusive 2.0 colour collection

Add exceptional character to your property with the unique depth effect of the HI 2.0 colours.

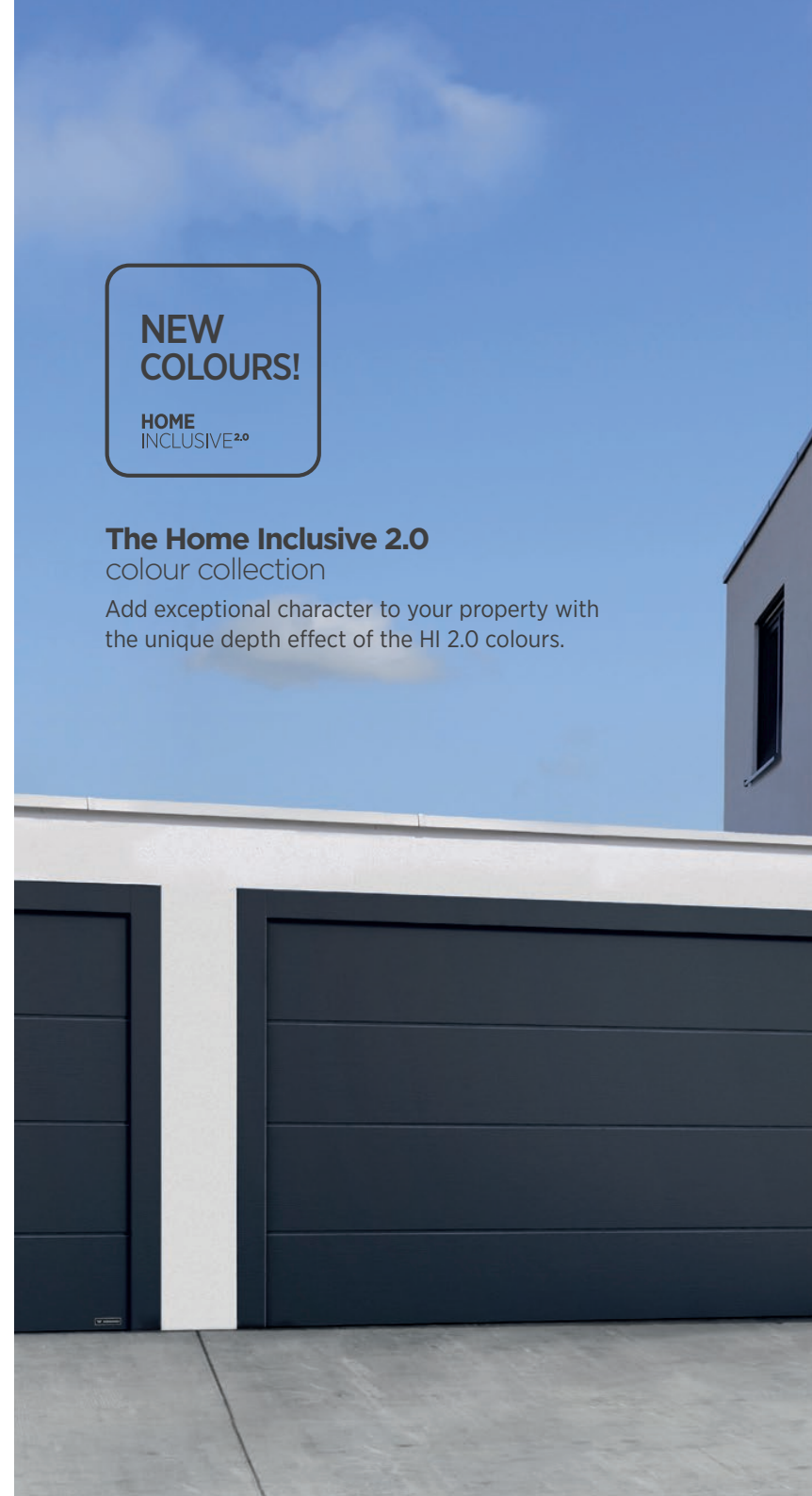



So much **sun...**

We feel better when we stay in bright rooms. Large windows with a proper thermal transmittance factor make it possible to make better use of daylight in order to maintain optimal interior temperature. Therefore, they have a positive effect on your heating and electricity bills.

WIŚNIEWSKI uses top quality glass which guarantees that the rooms are bright and warm. You can select the glass type according to your needs and preferences, we offer coloured, mat, and anti-burglary versions, among others.



SAFETY GLASS

Depending on the type of application, we use tempered or laminated safety glass. If broken, safety glass protects against cutting.

TEMPERED GLASS – glass subjected to thermal treatment to cause stress in the glass, increasing its mechanical strength.

Tempered glass demonstrates higher mechanical strength and breaks into small pieces unlikely to cause injury and is thus classified as safety glass.

LAMINATED GLASS – glass subjected to lamination consisting in joining two or more layers of glass with special foil on a lamination line. This method can be used to combine various types of glass of any thickness, and by using colour or decorative films, both performance and appearance can be improved.

This process makes it possible to obtain safety glass, whose pieces, when broken, do not separate but remain in place and prevent injury.



Low-emission glass – glass units are made of low-emission glass and directly contribute to lowering the thermal transmittance factor, so they improve thermal insulation. Their properties make it possible to reduce heat loss and save energy, reduce cold spots and increase the temperature of internal glass, consequently decreasing the condensation effect.

Solar control glass – used in the case of buildings which are heavily exposed to sun and prone to excessive overheating by the sun. Depending on the climate, this glass serves to minimize heat gain and limit the dazzling effect (hot climate), as well as balance the protection against sun and high level of access to natural daylight (temperate climate).

Soundproof glass – provides increased noise attenuation characteristics. High sound insulation is achieved with different glass thickness within the unit and with the use of a special film. This type of glass is increasingly used in the construction of commercial buildings, as well as in residential buildings in areas particularly exposed to noise.

Security glass – burglary- and bullet-resistant glass. Its properties increase the level of resistance to burglary or an attack with firearms. At the same time, it ensures a suitable level of natural lighting by eliminating the need for window bars or shutters.

Self-cleaning glass – for use in external applications. Recommended for windows and walls with difficult access, where organic dirt typically accumulates. Self-cleaning properties are achieved thanks to a special double-action coating, which breaks down dirt clusters and allows rainwater to spread evenly and clean the loosened dirt.

Decorative glass – perfect for windows, partition walls, and other interior decorative elements. It has a high visual appeal and provides unlimited design possibilities. Ensures a sense of privacy, while at the same time allowing light to pass.

External roller shutters **PROTECTA**

WIŚNIEWSKI roller shutters ensure that the space most important to your family is always protected. That is why we gave this range a name derived from the word “protect”. In the summer, they do not let sun rays get inside your home on the hottest of days, while in the winter, they keep more heat inside – to help you save on air conditioning and heating bills. Their special design additionally quietens noises coming from the outside and makes your private space a genuine oasis, even when buildings in your neighbourhood are densely arranged. The Protecta roller shutters are a functional addition to the PRIMO and FUTURO windows.



FUNCTIONALITY





Roller shutter types.

Which one to choose?

Three WIŚNIEWSKI external roller shutter systems were adapted to various needs and construction stages. If you are only starting the construction of your house, flush-mounted or top-mounted roller shutters will be your best bet. Type P and N roller shutter boxes are concealed under a thermal insulation layer so that they do not affect the look of the façade. If you are planning to install a roller shutter system in an existing building without having to deal with cutting out a recess to mount it, choose the Protecta A roller shutters which can be fitted to the window or the thermal insulation layer.

Setting the type of roller shutters aside, you also have to pick a colour that will match the windows in your home. The WIŚNIEWSKI Protecta roller shutters are available in as many as 18 colour versions. Moreover, you can take advantage of optional accessories and variants to adapt them to your individual needs even better.

1. Roller shutter box. 2. Winding tube. 3. Roller shutter drive unit. 4. Aluminium profile curtain. 5. Bottom strip. 6. Tracks.

PROTECTA P

This flush-mounted roller shutter system is mainly intended for use in houses under construction. It can also be used when redoing the building insulation or modernising the current one – provided that the required changes in the lintel are made.



PROTECTA A

Protecta A are external front-mounted roller shutters. They are intended for buildings in which windows have already been fitted or where because of various reasons, other roller shutter systems cannot be used. A selection of the right box colour will make the roller shutters match the windows you chose at an earlier stage.



PROTECTA N

A system of top-mounted roller shutters that is mainly used in houses under construction. However, it can also be used in existing buildings, e.g. when the joinery is being replaced. The roller shutter box is placed directly over the window – it is not visible from the outside.



OPTIONAL ACCESSORIES FOR EXTERNAL ROLLER SHUTTERS

Add some functional accessories to your Protecta roller shutters and take advantage of the available variants. You can control the roller shutters remotely with a dedicated remote or with a smartphone thanks to the smartCONNECTED concept and our proprietary application.



TaHoma® Premium
smart home central control unit



S&SO-RS100 io motor (the latest Somfy roller shutter motor)



Self-locking hook
Somfy LOCK TO PLAY



Situo io II remotes
Somfy remotes with the io technology

EXTERNAL ROLLER SHUTTERS CURTAIN TYPES



Perforated curtain



Non-perforated curtain

The curtain without perforation ensures full insulation from the wind and sun, while the perforated version enables room ventilation when the roller shutter is slightly lifted in the closed position. The perforation additionally slightly brightens the home interior.

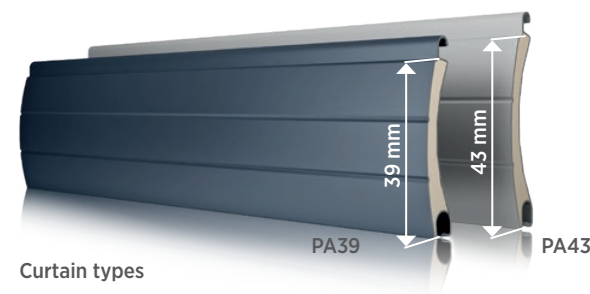

Curtain types

PA39 curtain – max. surface area 6 m², max. width – 3,200 mm,
PA43 curtain – max. surface area 9 m², max. width – 3,300 mm.

ROLLER SHUTTER CURTAINS – basic colours



ROLLER SHUTTER CURTAINS – special colours



Due to technical reasons, actual colours may differ from those represented in the pictures and photographs. Please consult the dealer upon purchase.

⁽¹⁾ – PLEASE NOTE! Colours available only with the PA39 curtain.

INSPIRATION



PRIMO window | HI MODERN GRAPHITE
PRIME | HI MODERN GRAPHITE
Modern | AW.10.104 | HI MODERN GRAPHITE
CREO | HI MODERN GRAPHITE



PRIMO window | Anthracite grey

INSPIRATION



PRIMO WINDOW



PRIMO WINDOW

INSPIRATION



PRIMO WINDOW





PRIMO window | Winchester

INSPIRATION



PRIMO WINDOW

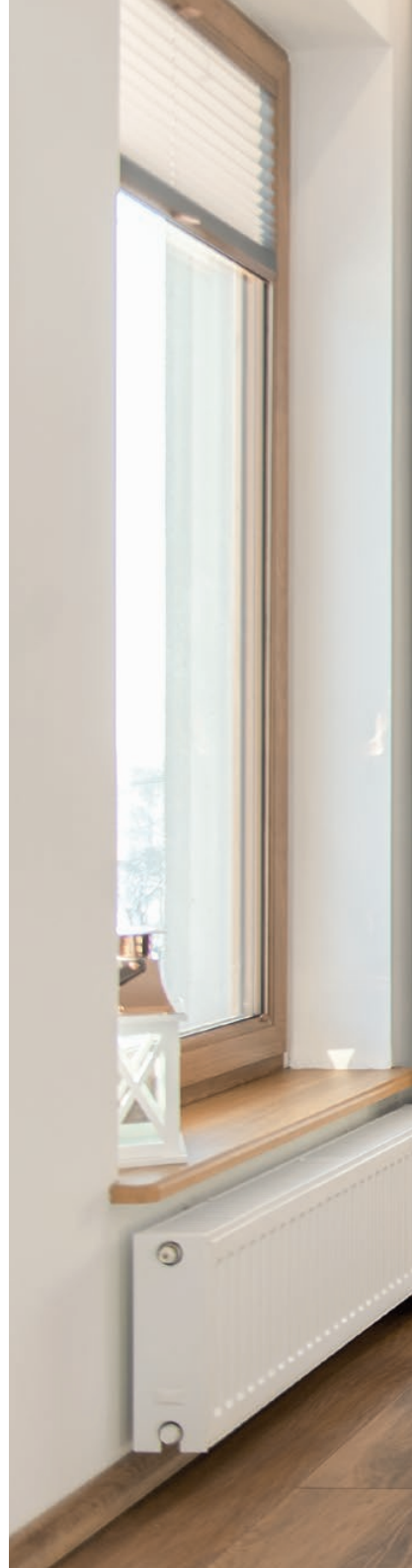



PRIMO window | Winchester

INSPIRATIONS



PROTECTA roller shutter





PROTECTA roller shutter



PROTECTA roller shutter

It's great when everything **goes** **together perfectly...**

because harmony is the highest form of beauty. Choose your **garage door, windows,** and **shutters,** as well as **doors** and **fence** in the Home Inclusive™ system, which will create a matching set in terms of design and colour. Highlight this harmony with the smartCONNECTED smart control function and meet perfection that will never go out of fashion. A matching set of joinery and fence? From a single manufacturer in uniform design – because it is great when all the elements harmonize with your dreams, your home, and one another.



HI MARINA HORIZO



LET US INSPIRE YOU WITH OUR NEW HOME INCLUSIVE COLLECTION FEATURING 16 UNIQ

HI EARTH





HI QUARTZ GREY



ON

HI ANTHRACITE



HI DEEP GREEN



UE COLOURS!

HI STONE



HI STEEL



HI RUBY





WIŚNIEWSKI

GATES | WINDOWS | DOORS | FENCES



DISCOVER
MORE...



www.wisniowski.eu

The products shown in the photographic material often feature special equipment and do not always correspond to their standard versions • This brochure does not constitute an offer within the meaning of the Polish Civil Code.
• The manufacturer reserves the right to introduce changes without notice. • NOTE: The colours shown in this brochure are for reference only • All rights reserved • Copying and use, in part or in full, is prohibited without the consent of WIŚNIEWSKI Sp. z o.o. S.K.A. • 12/21/EN