

GERDA[®]

PREMIUM DOOR MANUFACTURER

APARTMENT
DOORS

STAR 60
PREMIUM 60
COMFORT 60

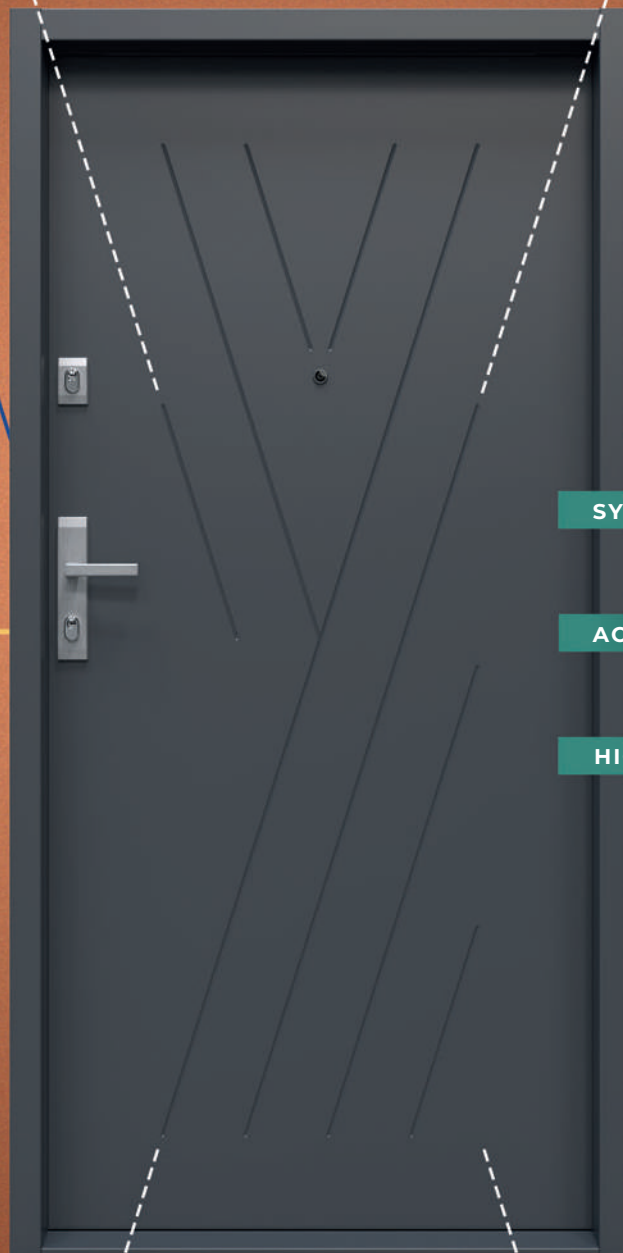

SYNONYMOUS WITH SAFETY

ACOUSTIC COMFORT

HIGHEST QUALITY STANDARDS

EDITION 2.2024



DOORS



Our door frame and leaf solutions are perfect even for the most demanding facilities. Panel and metal doors in our offer feature superior durability, functionality (e.g. easy removal and replacement of a door panel) and the freedom of arrangement.

GATES



All garage gates in our offer comply with European standards. GERDA gates are fitted with comprehensive protection systems with no extra charge.

The "Trend" gate range is an economic but durable and functional solution, perfect for developer facilities.

The "Classic" gate range ensure very good thermal insulation, among others by means of 45-mm thick warm panels. Perfect for buildings with high energy efficiency requirements.

LOCKS AND HARDWARE



Security first. Heat-treated inner die casts or steel plates ensure high resistance to burglary. Hardened tumbler insert cover protects against wrenching off and prevents drilling.

The MASTER KEY system is a solution dedicated for commercial facilities. A single key may be used to open a pre-determined number of locks. This way, moving around the facility is quick and easy, while zone and room access management is very comfortable.

ALUMINUM JOINERY



GERDA also offers aluminum joinery. We build partition walls, doors, windows, shop windows and both indoor and outdoor spatial installations, also in fire-resistant and smoke-tight or high burglary-resistant versions.

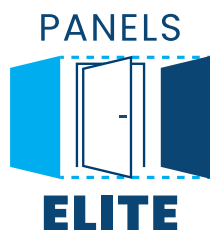

Changing the color of a door leaf? It's easy as one, two, three...!

Panel doors are ideal as flat doors when you want to give them a diverse visual character. The easy mounting method allows quick removal and replacement in case of damage or rearrangement, without the need for costly replacement of the entire door. ELITE panels are mounted to the steel leaf, providing additional strength and rigidity. At the customer's request, the outer and inner panels can differ in colour. The panels also provide additional thermal and acoustic protection.



Safety first

All of our doors have a reinforced construction, with solutions that make them more difficult to force. They also have burglar-proof door cylinder, for which the Gerda brand is famous. In order to confirm the burglar-proof parameters, the doors undergo special tests and examinations to be certified as RC4, RC3, and RC2 respectively. Current approvals and certificates are available for download from www.gerda.pl.



Relax in blissful silence

When buying a flat door, it is worth paying attention to acoustic comfort, so that as little as possible outside noises reach our apartment, and as little as possible sounds from the apartment get out into the stairwell. The higher the weighted sound reduction index measured in dB (decibels), the better the sound barrier our doors are. Gerda flat doors, which have an index of up to 42 dB, are able to reduce noise from 80 dB even to the level of a quiet conversation.



Fire and smoke protection

The fire protection package available in the PREMIUM 60 door line, is designed to stop the spread of fire and smoke in the event of a fire. Products with the aforementioned properties are marked with the symbol EI, where E stands for fire tightness and I for insulation. Gerda doors have the parameter EI30, EI45 and EI60, respectively, which means protection for 30, 45 and 60 minutes. This ensures that the flames do not spread to the other side of the door during this time, further protecting against the spread of fire.



Thermal insulation

We are the few who also test the thermal transmittance of the flat doors. Both the PREMIUM 60 and COMFORT 60 series doors have a low $UD=1.3$ W/m²K transmittance rate. Doors protect the flat from cold coming in from the stairwell in winter and heat in summer. This has a positive effect on heating and air conditioning bills, bringing real savings to the household budget.



Gerda equals peace of mind for years

Gerda provides a 3-year product warranty with just a few requirements. All you have to do is register the product at www.gerda.pl, document on the warranty card the installation performed by a certified fitter, and perform a professional inspection and door adjustment documented on the warranty card once between 18 and 24 months. The standard warranty is 24 months.

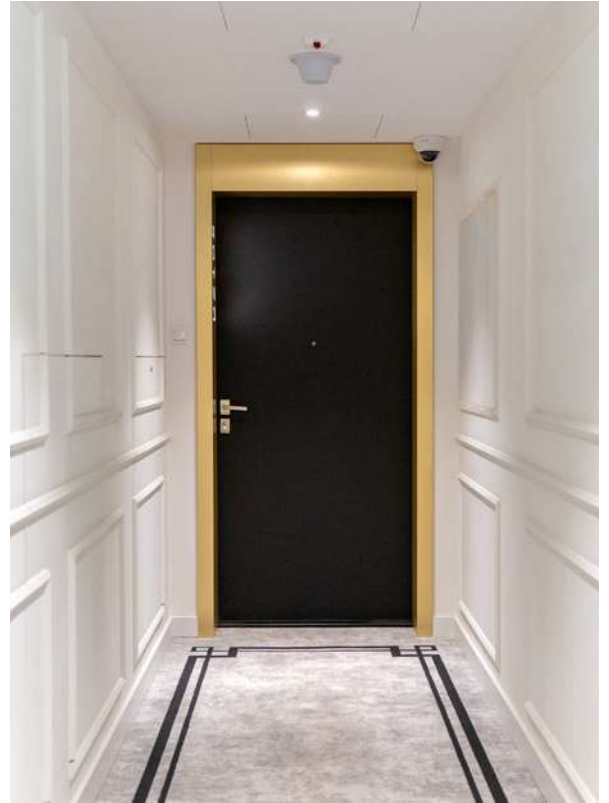

tedee PRO

powered by **GERDA**[®]

TURN YOUR SMARTPHONE INTO A SMART DOOR LOCK



OPEN DOORS WITH YOUR SMARTPHONE

Open and close doors and monitor door lock status from any place around the world. With the automatic opening feature, you don't need to take your phone out from your purse or pocket. The lock will detect your presence and let you in. The self-locking feature works based on the same principle.

SET

tedee PRO SMARTLOCK + tedee BRIDGE + CLASS 6 LOCK CYLINDER

HIGH-PERFORMANCE BATTERY

Gerda engineers, in collaboration with the South Korean Research Institute, have developed a small dedicated high-performance battery. It powers the mechanism for six months of operation. And when in need of recharging, the lock will let you know as you can charge the battery overnight.

SAFETY WARRANTY

The lock actuating mechanism is an innovative, patented design developed by Gerda engineers. The software was created by Tedee IoT experts. An intuitive app lets you keep track of who and when has locked or unlocked the door. It also offers a virtual key allocation feature.



CLASS 6 LOCK CYLINDERS INCLUDED

- ✓ ANTI-BURGLARY TUMBLER LOCK INSERT. NEW LOCK INSERT DESIGN SECURED AGAINST 'LOCK BUMPING', WITH EFFECTIVE DRILL OPENING PROTECTION.

INSTALL A TEDEE LOCK

- ✓ SLIDE THE LOCK ONTO A GERDA INSERT, ADJUST THE LOCK POSITION AND SECURE IT WITH ONE BOLT. INSTALLATION TAKES NO MORE THAN TWO MINUTES. INSPECT TO SEE WHETHER THE BOLTS SLIDE UPON TURNING THE KNOB.

INSTALL THE SMARTPHONE APP

- ✓ DOWNLOAD THE **tedee** APP FROM APPLE STORE OR GOOGLE PLAY. SIGN UP AND ACTIVATE YOUR BLUE-TOOTH, LOCATION SERVICE AND INTERNET ACCESS. ADD YOUR LOCK AND ENTER THE ACTIVATION CODE.

CONNECT THE BRIDGE

- ✓ FIND A FREE POWER SOCKET NEXT TO THE **tedee** LOCK AND PLUG THE BRIDGE IN. THIS WILL ENABLE YOU TO CONTROL THE LOCK OVER THE INTERNET FROM WHEREVER YOU ARE.

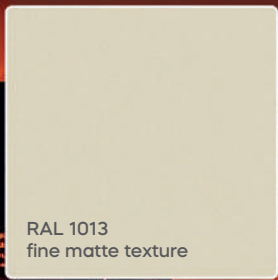

GALA colour range of RAL powder coatings

The **GALA** colour range is the series of powder coatings in a fine-textured version inspired by the energy and dynamics of urban life. Includes bold shades of gray, red and anthracite reflecting the bustling streets, buildings, and ubiquitous neon lights.

The palette contains 30 colors

The available palette of RAL lacquered colours can be found in the visual configurator and in the Showrooms.



GALACTICA colour range of fine texture metallics powder coatings

GALACTICA is another line of powder-coated fine-textured finishes with a metallic effect. It's a connection between our skies and outer space. Delicate blue colours mix with the setting sun and the view of the stars.

The palette contains 25 colors

A range of metallics powder coating colours is available in the visual configurator and in the Showrooms.



PREMIUM 60 · COMFORT 60



TOLEDO

DEBOSSÉD + GALACTICA MERLOT + INOX INSERT

PREMIUM 60 · COMFORT 60



TOLEDO

DEBOSSÉD + INOX INSERT

PREMIUM 60 · COMFORT 60



TAHOMA

DEBOSSÉD

PREMIUM 60 · COMFORT 60



VICTORIA

DEBOSSÉD

PREMIUM 60 · COMFORT 60



TRENTINO

DEBOSSÉD

PREMIUM 60 · COMFORT 60



BERNO

ELITE 3D

PREMIUM 60 · COMFORT 60



TORONTO
DEBOSSÉ

PREMIUM 60 · COMFORT 60



VANCOUVER
DEBOSSÉ

PREMIUM 60 · COMFORT 60



VERACRUZ
DEBOSSÉ

PREMIUM 60 · COMFORT 60



VISP
ELITE 3D

PREMIUM 60 · COMFORT 60



TRIN
ELITE 3D

PREMIUM 60 · COMFORT 60



OLTEN
ELITE 3D

PREMIUM 60 · COMFORT 60



TOLEDO B

DEBOSSED + BLACK INSERT

PREMIUM 60 · COMFORT 60



TOLEDO B

DEBOSSED + BLACK INSERT

STAR 60 · PREMIUM 60



RLF B

ELITE PACK + BLACK INSERT

STAR 60 · PREMIUM 60 · COMFORT 60



TOKIO 1 B

BLACK INSERT

STAR 60 · PREMIUM 60 · COMFORT 60



TOKIO 2 B

BLACK INSERT

STAR 60 · PREMIUM 60



RHH B

ELITE Package + BLACK INSERT



All existing and new designs of doors with inserts are now available in black - **2020 BLACK.**

STAR 60 · PREMIUM 60 · COMFORT 60



PLAIN

STAR 60 · PREMIUM 60



PLAIN
ELITE Package

STAR 60 · PREMIUM 60 · COMFORT 60



TOKIO 1
INOX INSERT

STAR 60 · PREMIUM 60



VA3
ELITE PACK

STAR 60 · PREMIUM 60



VA4
ELITE PACK

COMFORT 60



TOKIO 1
DEBOSSED

STAR 60 · PREMIUM 60 · COMFORT 60



TOKIO 2
INOX INSERT

STAR 60 · PREMIUM 60



RLF
ELITE PACK + INOX INSERT

STAR 60 · PREMIUM 60



RHH
ELITE PACK + INOX INSERT

COMFORT 60



TOKIO 2
DEBOSSÉ

COMFORT 60



TROMSO 1
DEBOSSÉ

COMFORT 60



LONDYN
DEBOSSÉ

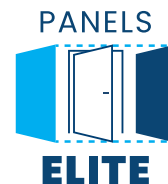

3 years
WARRANTY
GERDA®

STAR 60



ANTI-BURGLARY PROTECTION CLASS

RC4



LEAF THICKNESS
LEAF THICKNESS WITH ELITE PACKAGE*

60 mm
70 mm*



SOUND REDUCTION INDEX

38 dB



DOOR LEAF FILLING

POLYURETHANE FOAM FILLING + SOUNDPROOFING PACK



DOOR SIZES

80N · 80 · 90N · 90E · 100E*

* EXTRA CHARGE, FOR MORE INFORMATION SEE PAGE 14

The **STAR 60** door series is Gerda's flagship product. One could say "a real star" in the brand's portfolio. Solutions used in the area of security, have been developed over more than 30 years, setting the standards for burglar-proof doors as we know them today. The internal construction of the leaf, consulted with the Criminal Division of the Warsaw

Police Headquarters, and proven in numerous tests, is unrivaled when it comes to burglary resistance. The **STAR 60** door is a unique product, which also uses top-class cylinders, among them the unique RIM 6000 cylinder with a tubular key with 4 billion code combinations. All these features make **STAR 60** a unique product in the world.

SET (DOOR LEAF, DOOR FRAME, THRESHOLD, HARDWARE WITH HANDLES, MAIN LOCK WITH CYLINDER IN CLASS 6, ADDITIONAL LOCK WITH CYLINDER IN CLASS 5)



UNIQUE TUBULAR KEY

Patented **RIM6000** lock cylinder with a tubular key with over 4 billion code combinations.



DOOR LEAF FILLING

HCFC-free polyurethane foam with a soundproofing plate providing excellent acoustic performance.



LATTICE

A lattice with thickened steel channel bars and hardened rods in the steel body of the door leaf.



VIEWER

Wide-angle viewer as standard with a very good optical performance.



3 THREE-PIECE HINGES

Reinforced three-piece hinges with a disassembly lock and elegant caps.

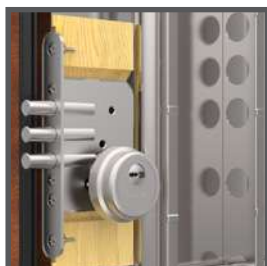

ADDITIONAL LOCK

Additional class 6 lock with a class 5 or class 6 lock cylinder.



MAIN LOCK WITH 11 LOCKING POINTS

Unique class 7 main lock with 11 mobile and thickened bolts.



AUXILIARY LOCKS

Auxiliary upper and lower locks controlled from the main lock.

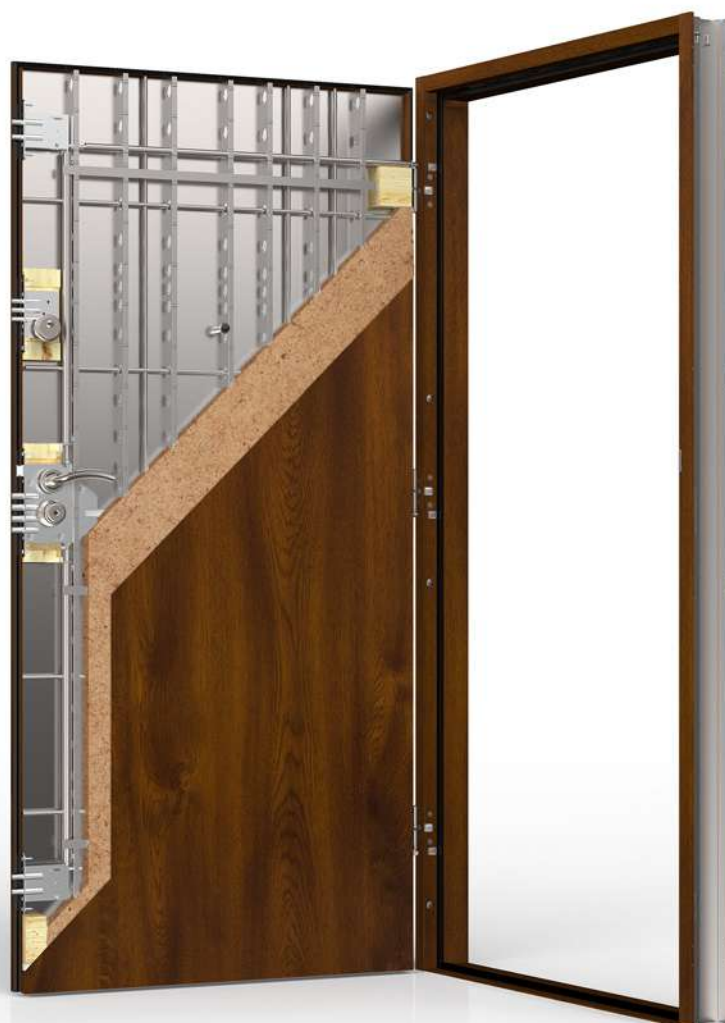

3 MOVABLE DEADBOLTS

Reinforced horizontal deadbolts on the hinge sides controlled from the main lock.

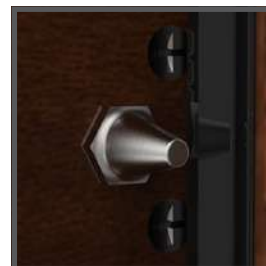

3 FIXED BOLTS

Fixed bolts protecting against forcing the door.



DOOR LATCH*

Optional protection against break-in through an ajar door.

AVAILABLE DOOR FRAMES

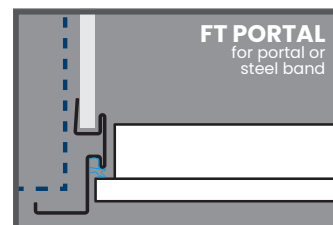
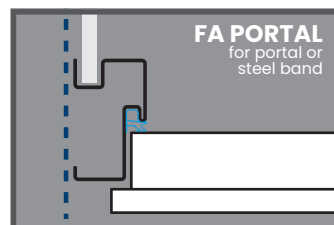
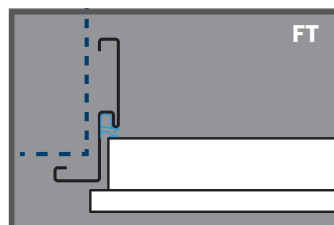
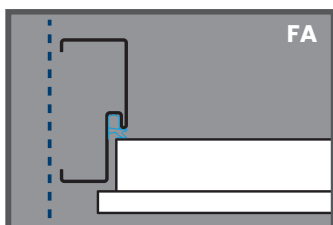

* EXTRA CHARGE, FOR MORE INFORMATION SEE PAGE 14



SIZE	80N	80	90N	90E	100E*
MODEL **					
W00	PLAIN	-			
R00	PLAIN	ELITE Package			
TML	TOKIO 1	single sided INOX INSERT double sided INOX INSERT			
TMLB	TOKIO 1 B	single sided BLACK INSERT double sided BLACK INSERT			
TMM	TOKIO 2	single side INOX INSERT double sided INOX INSERT			
MODEL **					
TMMB	TOKIO 2 B	single sided BLACK INSERT double sided BLACK INSERT			
RLF	RLF	ELITE Package + INOX INSERT			
RLFB	RLFB	ELITE Package + BLACK INSERT			
RHH	RHH	ELITE Package + INOX INSERT			
RHHB	RHHB	ELITE Package + BLACK INSERT			
VA3	VA3	ELITE Package			
VA4	VA4	ELITE Package			

→ AVAILABLE DOOR MODELS ON PAGES 6-11

RC4 STANDARD EQUIPMENT

SOUND REDUCTION INDEX 38 dB	HARDWARE: HANDLE-HANDLE SET TECHNO
DOOR FRAME WITH SEAL	MAIN LOCK CYLINDER IN CLASS 6
2D 3-PIECE HINGES WITH CAPS MATCHING FITTING'S COLOUR	ADDITIONAL LOCK CYLINDER IN CLASS 5
LAMINATED THRESHOLD WITH SEAL H=19 mm OR H=32 mm	MAIN LOCK CYLINDER: 5 X KEYS
ADDITIONAL LOCK WITH CYLINDER PROTECTION	ADDITIONAL LOCK CYLINDER: 5 X KEYS + INSTALLATION KEYS
VIEWER	DOOR LEAF THICKNESS 60 mm

EXTRA CHARGES

N POWDER COATING	GALA COLOUR RANGE
SIZE 100E	GALACTICA / GALA OPEN COLOUR RANGE
TWO-COLOUR DOOR, TERRA COLOUR RANGE	GALA COLOUR RANGE TWO-COLOUR DOOR
DOOR SHORTENING (20, 30, 40, 50, 60, 70 mm)	INOX THRESHOLD WITH SEAL H=19 mm OR H=32 mm
KNOB-HANDLE	NORWEGIAN WOODEN THRESHOLD WITH SEAL H=19 mm
ADDITIONAL LOCK CYLINDER IN CLASS 6	NORWEGIAN WOODEN THRESHOLD WITH ALUMINIUM STRIP AND SEAL H=28 mm
OPTIC F - 2,4" ELECTRONIC VIEWER	NORWEGIAN WOODEN THRESHOLD WITH WOODEN STRIP AND SEAL H=35 mm ¹
OPTIC M - 4,3" ELECTRONIC VIEWER	PRE-ASSEMBLED DOOR ³
DOOR LATCH (WITHOUT ELITE PACKAGE) ^{1,2}	

1 - for door frames extended by 6 mm, with the DPO mounting system
 2 - for door frames with the DPO mounting system, metal doors without ELITE Package
 3 - for selected configurations of door frames and thresholds

TERRA COLOUR RANGE

COLOURS OF PLAIN DOORS, DOORS WITH INSERTS, DOORS WITH ELITE PACKAGE (DOOR TRIMS, DOOR LEAVES, THRESHOLDS, DOOR FRAMES, REPLACEABLE PANELS)

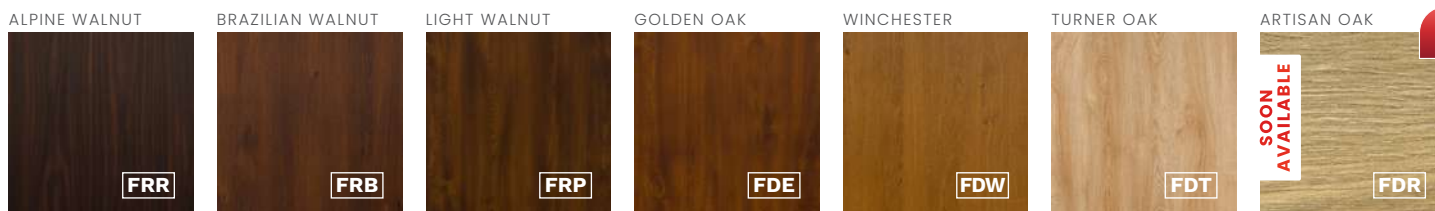

INSERT COLOURS

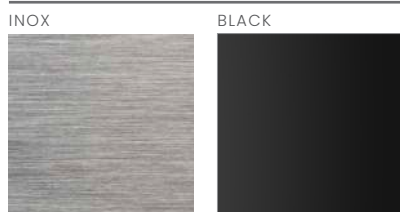

ADDITIONAL COLOURS OF REPLACEABLE ELITE PACKAGE PANELS*

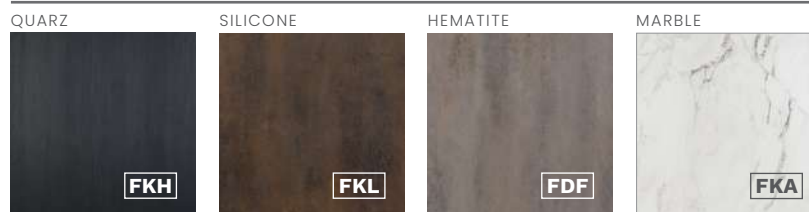

* EXTRA CHARGE

** SET (DOOR LEAF, THRESHOLD, DOOR FRAME, HARDWARE WITH HANDLES, LOCK CYLINDERS)

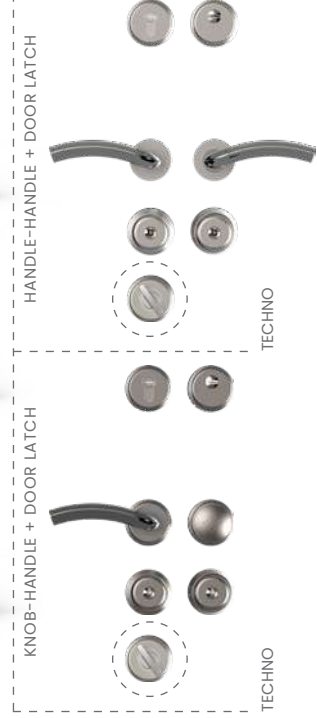
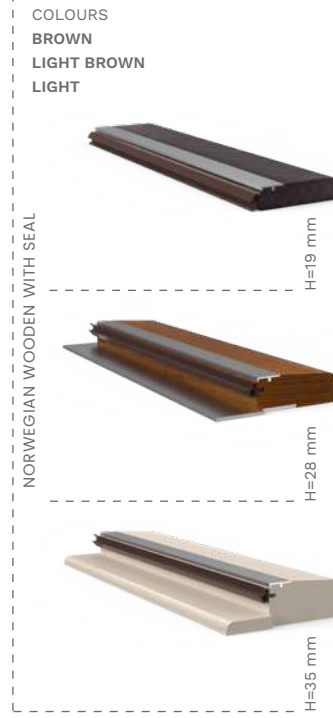
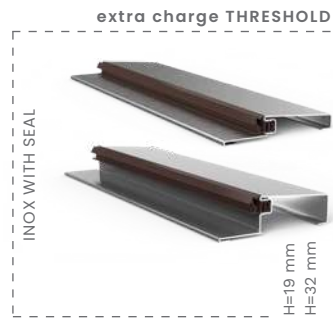
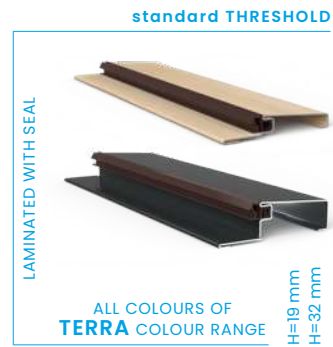

DOOR LATCH is not available for ELITE Package.

TERRA COLOUR RANGE

COLOURS OF PLAIN DOORS, DOORS WITH INSERTS, DOORS WITH ELITE PACKAGE (DOOR TRIMS, DOOR LEAVES, THRESHOLDS, DOOR FRAMES, REPLACEABLE PANELS)



ADDITIONAL COLOURS OF ELITE PACKAGE TRIMS AND DOOR FRAMES*



HARDWARE COLOUR





* EXTRA CHARGE



3 years
 WARRANTY
GERDA®



PREMIUM 60

	THERMAL INSULATION U _D VALUES FOR INWARD-OPENING REFERENCE DOORS	1,3 W/m²K**
	ANTI-BURGLARY PROTECTION CLASS	RC2 · RC3* · RC4*
	LEAF THICKNESS LEAF THICKNESS WITH ELITE PACKAGE*	60 mm 70 mm*
	SOUND REDUCTION INDEX	42 dB
	DOOR LEAF FILLING	SPECIAL SOUNDPROOFING PACKAGE
	FIRE RESISTANCE CLASS (FR)*	EI30^{AB} · EI45^B · EI60^A
	SMOKE TIGHTNESS CLASS*	S_a S₂₀₀ (EI30D^{AB} · EI45D^B · EI60D^A)
	DOOR SIZES	80N · 80 · 90N · 90Z · 100E^{C*}

A. EI30 AND EI60 AVAILABLE IN RC2 AND RC3 CLASS*
 B. EI30 UND EI45 AVAILABLE IN RC4 CLASS*
 C. SIZE 100E NOT AVAILABLE IN EI60 CLASS*

* EXTRA CHARGE, FOR MORE INFORMATION SEE PAGE 18
 ** NOT APPLICABLE TO DOORS WITH EI30 / EI45 / EI60 PACKAGE

RC2

RC3* · RC4*

$U_D = 1,3 \text{ W/m}^2\text{K}^{**}$

SET (DOOR LEAF, DOOR FRAME, THRESHOLD, HARDWARE WITH HANDLES, LOCKS WITH CYLINDERS IN CLASS 5)



VERTICAL DEADBOLT*

Anti-burglary vertical deadbolt controlled from the main lock. Available in the RC3 class.



DOOR LEAF FILLING

Special filling for good acoustic comfort.

EI30D* · EI45D* · EI60D*

PREMIUM 60 doors are also available with the FR (fire resistant) package and smoke tightness class S_{200} .



HARDENED BARS*

Specially developed design of thickened and hardened steel bar protecting against burglary. Available in RC3 and RC4 class.



VIEWER

Wide-angle viewer as standard with a very good optical performance.



3 x 3D HINGES

Hinges adjustable in three planes with caps matching hardware's colour.



ADDITIONAL LOCK

Additional burglar-proof lock cylinder in class 5 or 6.



MAIN LOCK

Class 7 main lock with reinforced deadbolt construction with class 5 or class 6 anti-burglary lock cylinder.



AUXILIARY LOCKS*

Lower and upper auxiliary locks with a double deadbolt system controlled from the main lock. Available in RC3 package (1 pc – lower) and RC4 package (3 pcs).



2 MOVABLE DEADBOLTS*

Reinforced horizontal deadbolts on the hinge sides controlled from the main lock. Available in RC4 class.

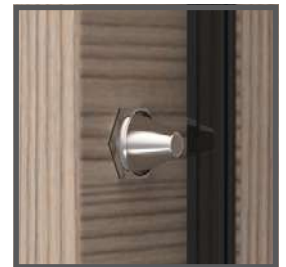

2 FIXED BOLTS

Fixed bolts protecting against forcing the door.



KEYED ALIKE SYSTEM

Unified lock cylinders can be opened with a single key.

AVAILABLE DOOR FRAMES

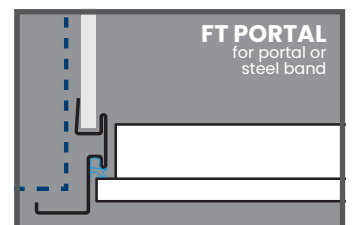
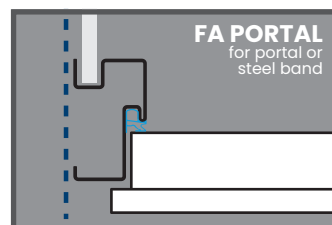
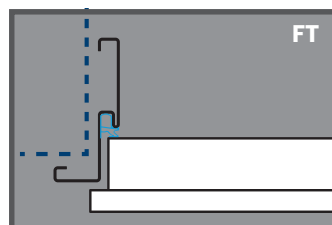
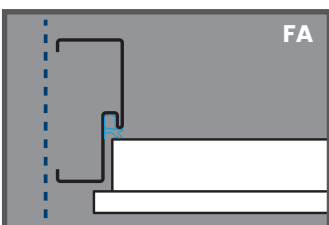

* EXTRA CHARGE, FOR MORE INFORMATION SEE PAGE 18

** NOT APPLICABLE TO DOORS WITH EI30 / EI45 / EI60 PACKAGE



SIZE	80N	80	90N	90Z	100E*
MODEL **			MODEL **		
W00	PLAIN	-	TOLB	TOLEDO B	single sided debossing + BLACK INSERT double sided debossing + BLACK INSERT
R00	PLAIN	ELITE Package	TOR	TORONTO	single sided debossing double sided debossing
TML	TOKIO 1	single side INOX INSERT double sided INOX INSERT	VAN	VANCOUVER	single sided debossing double sided debossing
TMLB	TOKIO 1 B	single sided BLACK INSERT double sided BLACK INSERT	VER	VERACRUZ	single sided debossing double sided debossing
TMM	TOKIO 2	single side INOX INSERT double sided INOX INSERT	VIC	VICTORIA	single sided debossing double sided debossing
TMMB	TOKIO 2 B	single sided BLACK INSERT double sided BLACK INSERT	TRE	TRENTINO	single sided debossing double sided debossing
RLF	RLF	ELITE Package + INSERT INOX	ELE	BERNO	single sided ELITE 3D double sided ELITE 3D
RLFB	RLFB	ELITE Package + INSERT BLACK	ELC	VISP	single sided ELITE 3D double sided ELITE 3D
RHH	RHH	ELITE Package + INSERT INOX	ELD	TRIN	single sided ELITE 3D double sided ELITE 3D
RHHB	RHHB	ELITE Package + INSERT BLACK	ELB	OLTEN	single sided ELITE 3D double sided ELITE 3D
VA3	VA3	ELITE Package	→ AVAILABLE DOOR MODELS ON PAGES 6-11		
VA4	VA4	ELITE Package			
TAH	TAHOMA	single sided debossing double sided debossing			
TOL	TOLEDO	single sided debossing + INOX INSERT double sided debossing + INOX INSERT			

RC2 STANDARD EQUIPMENT

SOUND REDUCTION INDEX 42 dB	VIEWER
THERMAL INSULATION U ₀ VALUE 1,3 W/m ² K	HANDLE-HANDLE: PRAGA, BERGEN, BLOK OR OSLO
DOOR FRAME WITH SEAL	LOCK CYLINDERS CLASS 5
ADJUSTABLE 3D HINGES WITH CAPS	KEYED ALIKE SYSTEM
LAMINATED THRESHOLD WITH SEAL H=19 mm / H=32 mm	5 X KEYS + INSTALLATION KEYS
HARDWARE SET WITH MAIN LOCK CYLINDER PROTECTION	DOOR LEAF THICKNESS 60 mm

EXTRA CHARGES

N POWDER COATING	GALA COLOUR RANGE
RC3 PACKAGE WITH HARDWARE BERGEN OR BLOK	GALACTICA / GALA OPEN COLOUR RANGE
RC3 PACKAGE WITH HARDWARE PRAGA	GALA COLOUR RANGE TWO-COLOUR DOOR
RC4 PACKAGE WITH HARDWARE BERGEN OR BLOK	INOX THRESHOLD WITH SEAL H=19 mm OR H=32 mm
FR PACKAGE + SMOKE TIGHTNESS CLASS S _a , S200 WITH INTEGRATED DOOR CLOSER	NORWEGIAN WOODEN THRESHOLD WITH SEAL H=19 mm
EI30 - DROP-DOWN THRESHOLD 7	NORWEGIAN WOODEN THRESHOLD WITH ALUMINIUM STRIP AND SEAL H=28 mm
OPTIC F - ELEKTRONIC VIEWER 2,4"	NORWEGIAN WOODEN THRESHOLD WITH WOODEN STRIP AND SEAL H=35 mm ¹
OPTIC M - ELEKTRONIC VIEWER 4,3"	DOOR SIZE 100E
TWO-COLOUR DOOR, TERRA COLOUR RANGE	DOOR LATCH (NOT AVAILABLE FOR: RC4, FR PACKAGE AND ELITE PACKAGE) ^{1,2}
DOOR SHORTENING (20, 30, 40 ³ , 50, 60 ³ , 70, 100 mm) ⁴	REED SWITCH
PREPARATION FOR HOTEL LOCKS ⁸	ADDITIONAL LOCK WITH CYLINDER PROTECTION (FR PACKAGE NO EXTRA CHARGE)
KNOB-HANDLE	DOOR HEIGHT RAISED 100 mm ⁶
PRE-ASSEMBLED DOOR ⁵	PREMIUM 60 (RC2, RC3) +EI30
LOCK CYLINDERS CLASS 6, KEYED ALIKE SYSTEM (RC4 PACKAGE NO EXTRA CHARGE)	PREMIUM 60 ELITE PACKAGE (RC2, RC3) +EI30
	tedee PRO SET
	1 - for door frames extended by 6 mm, with the DPO mounting system
	2 - for door frames with the DPO mounting system, metal doors
	3 - not applicable to FR Package
	4 - RC4 Package door shortening 20, 35 mm
	5 - for selected configurations of door frames and thresholds
	6 - not applicable to Smoke Tightness Class doors
	7 - combined with standard threshold
	8 - on a special request

TERRA COLOUR RANGE

COLOURS OF PLAIN DOORS, DOORS WITH INSERTS, DOORS WITH ELITE PACKAGE (DOOR TRIMS, DOOR LEAVES, THRESHOLDS, DOOR FRAMES, REPLACEABLE PANELS)

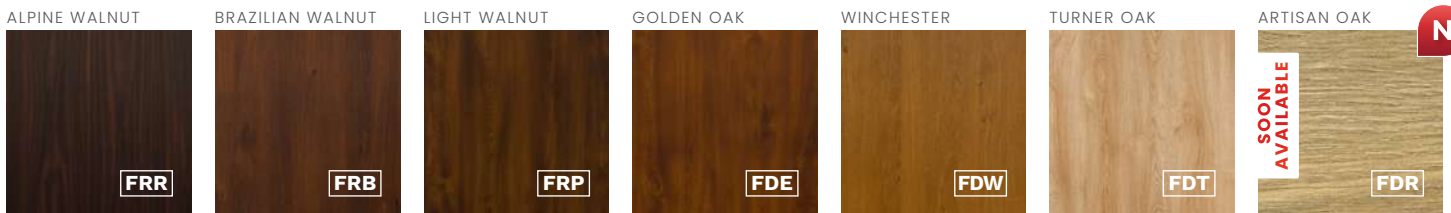

INSERT COLOURS

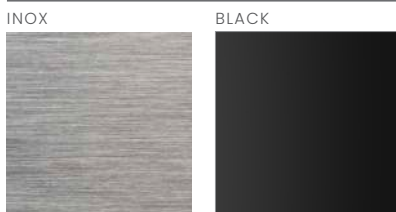

ADDITIONAL COLOURS OF REPLACEABLE ELITE PACKAGE PANELS*

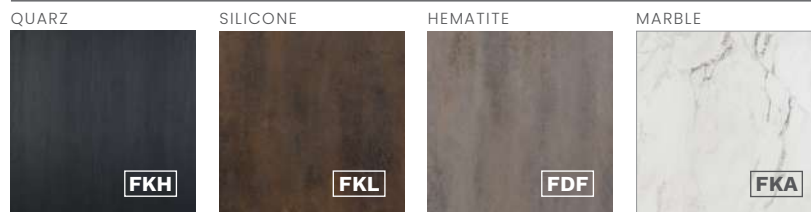

* EXTRA CHARGE

** SET (DOOR LEAF, THRESHOLD, DOOR FRAME, HARDWARE WITH HANDLES, LOCK CYLINDERS)



standard THRESHOLD



extra charge THRESHOLD

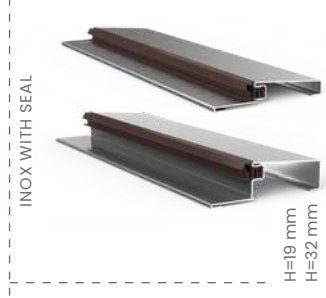

COLOURS
BROWN
LIGHT BROWN
LIGHT



extra charge HARDWARE

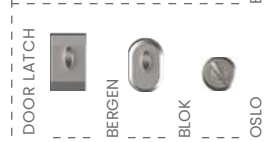

Door latch is not available for packages: RC4, FR, ELITE.



standard HARDWARE

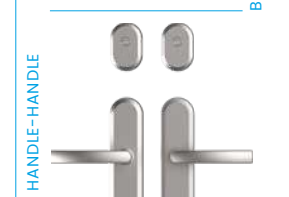
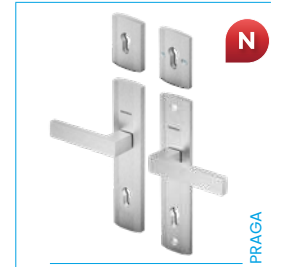

OSLO Hardware is not available for FR Package.

TERRA COLOUR RANGE

COLOURS OF PLAIN DOORS, DOORS WITH INSERTS, DOORS WITH ELITE PACKAGE (DOOR TRIMS, DOOR LEAVES, THRESHOLDS, DOOR FRAMES, REPLACEABLE PANELS)

LIGHT WENGE



WHITENED WENGE

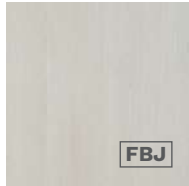

STEEL-GRAY



DARK ANTHRACITE

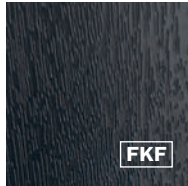

WHITE



ANTHRACITE



BLACK



ADDITIONAL COLOURS OF ELITE PACKAGE TRIMS AND DOOR FRAMES*

GREY



DARK BROWN



HARDWARE COLOURS: PRAGA, BERGEN UND BLOK

PLATINUM ANODE



SILVER ANODE



BLACK ANODE



OSLO HARDWARE

SATIN NICKEL



* EXTRA CHARGE

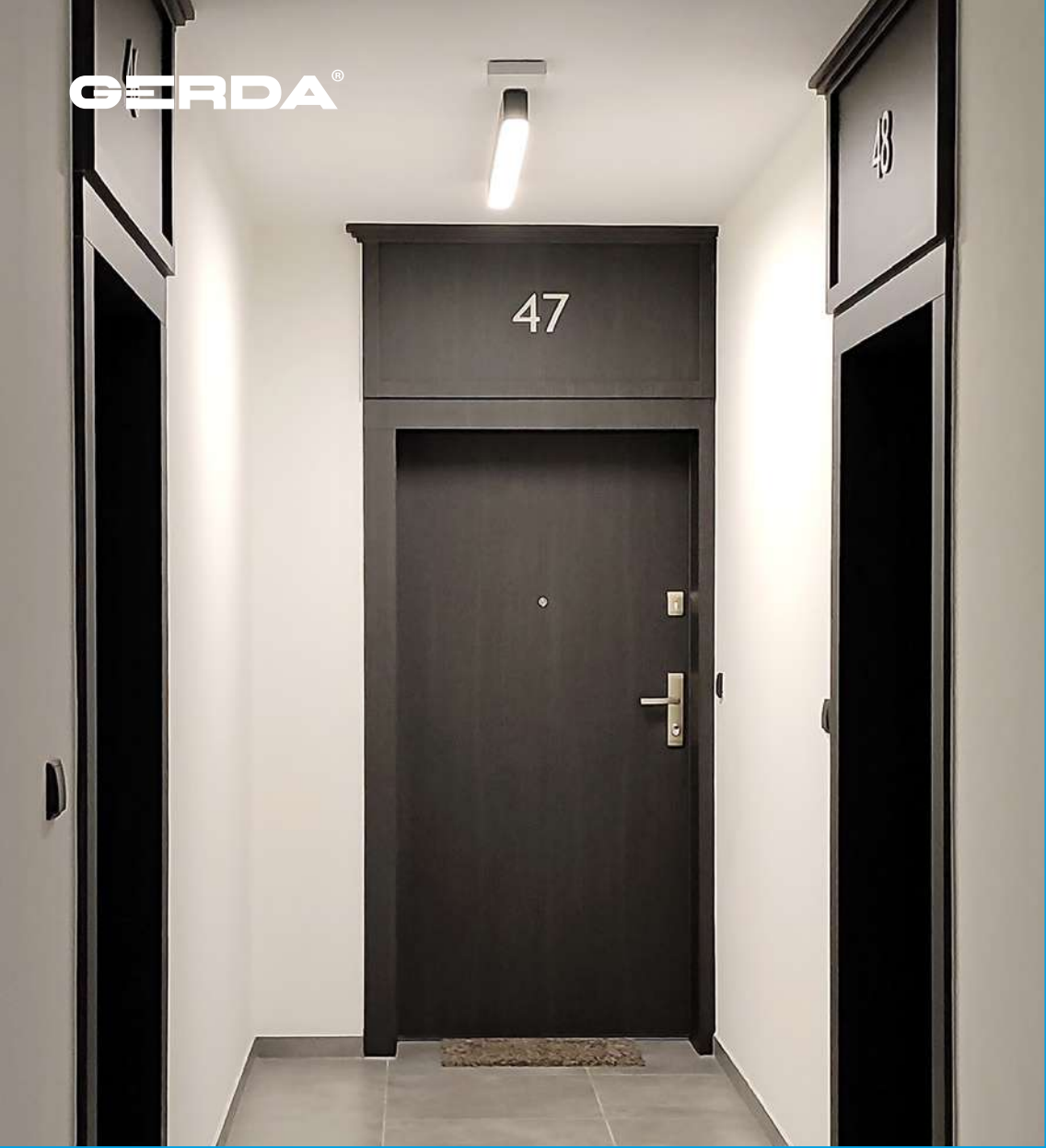

3 years
WARRANTY
GERDA®



COMFORT 60



THERMAL INSULATION
U_D VALUES FOR INWARD-OPENING
REFERENCE DOORS

1,3 W/m²K



ANTI-BURGLARY PROTECTION CLASS

RC2 · RC3*



LEAF THICKNESS

60 mm



SOUND REDUCTION INDEX

30 dB · 33 dB*



DOOR LEAF FILLING

SOUNDPROOFING PACKAGE



DOOR SIZES

80N · 80 · 90N · 90Z · 100E^{c*}

* EXTRA CHARGE, FOR MORE INFORMATION SEE PAGE 22

RC2

RC3*

$U_d = 1,3 \text{ W/m}^2\text{K}$

SET (DOOR LEAF, DOOR FRAME, THRESHOLD, HARDWARE WITH HANDLES, LOCKS WITH CYLINDERS IN CLASS 5)

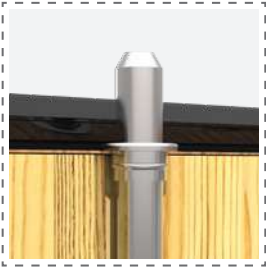

VERTICAL DEADBOLT*

Anti-burglary vertical deadbolt controlled from the main lock. Available in the RC3 class.



DOOR LEAF FILLING

Special filling for good acoustic comfort.



HARDENED BARS*

Specially developed design of thickened and hardened steel bar protecting against burglary. Available in RC3 and RC4 class.



VIEWER

Wide-angle viewer as standard with a very good optical performance.



3 X 3D HINGES

Hinges adjustable in three planes with caps matching hardware's colour.



ADDITIONAL LOCK

Additional burglar-proof lock cylinder in class 5 or 6.



MAIN LOCK

Class 7 main lock with reinforced deadbolt construction with class 5 or class 6 anti-burglary lock cylinder.



AUXILIARY LOCK*

Lower auxiliary lock with a double deadbolt system controlled from the main lock. Available in RC3 package.



2 FIXED BOLTS

Fixed bolts protecting against forcing the door



KEYED ALIKE SYSTEM

Unified lock cylinders can be opened with a single key.



DOOR LATCH*

Optional protection against break-in through an ajar door.

AVAILABLE DOOR FRAMES

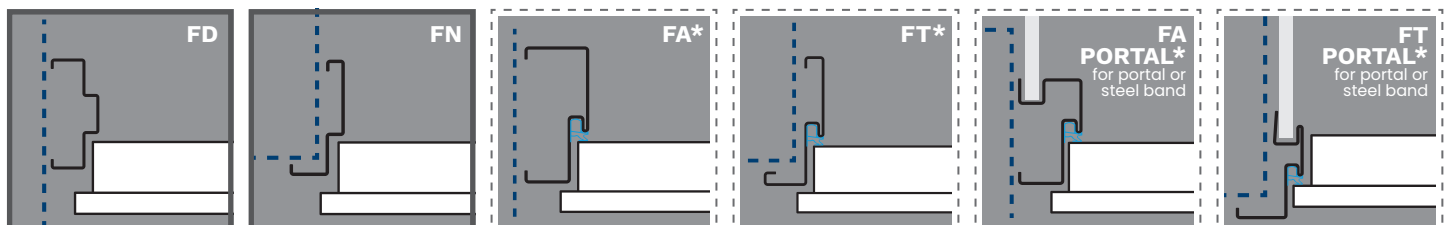

* EXTRA CHARGE, FOR MORE INFORMATION SEE PAGE 22



SIZE	80N	80	90N	90Z	100E*
MODEL **			MODEL **		
W00	PLAIN	-	TAH	TAHOMA	single sided debossing double sided debossing
W13	LONDYN	double sided debossing ³	TOR	TORONTO	single sided debossing double sided debossing
TMT	TOKIO 1	double sided debossing ³	VAN	VANCOUVER	single sided debossing double sided debossing
TMU	TOKIO 2	double sided debossing ³	VER	VERACRUZ	single sided debossing double sided debossing
SR4	TROMSO 1	double sided debossing ³	VIC	VICTORIA	single sided debossing double sided debossing
TML	TOKIO 1	single side INOX INSERT ³ double sided INOX INSERT ³	TRE	TRENTINO	single sided debossing double sided debossing
TMLB	TOKIO 1 B	single sided BLACK INSERT ³ double sided BLACK INSERT ³	ELE	BERNO	single sided ELITE 3D double sided ELITE 3D
TMM	TOKIO 2	single side INOX INSERT ³ double sided INOX INSERT ³	ELC	VISP	single sided ELITE 3D double sided ELITE 3D
TMMB	TOKIO 2 B	single sided BLACK INSERT ³ double sided BLACK INSERT ³	ELD	TRIN	single sided ELITE 3D double sided ELITE 3D
TOL	TOLEDO	double sided INOX INSERT ³ single sided BLACK INSERT ³	ELB	OLTEN	single sided ELITE 3D double sided ELITE 3D
TOLB	TOLEDO B	single sided BLACK INSERT ³ double sided BLACK INSERT ³	→ AVAILABLE DOOR MODELS ON PAGES 6-11		

RC2 STANDARD EQUIPMENT

SOUND REDUCTION INDEX 30 dB	VIEWER
THERMAL INSULATION U ₀ VALUE 1,3 W/m ² K	HANDLE-HANDLE: PRAGA, BERGEN, BLOK OR OSLO
DOOR FRAME WITHOUT SEAL	LOCK CYLINDERS CLASS 5
ADJUSTABLE 3D HINGES WITH CAPS	KEYED ALIKE SYSTEM
LAMINATED THRESHOLD WITH SEAL H=19 mm / H=32 mm	5 X KEYS + INSTALLATION KEYS
HARDWARE SET WITH MAIN LOCK CYLINDER PROTECTION	DOOR LEAF THICKNESS 60 mm

EXTRA CHARGES

N POWDER COATING	GALA COLOUR RANGE
SOUNDPROOFING PACKAGE 33 dB	GALACTICA / GALA OPEN COLOUR RANGE
DOOR FRAME WITH SEAL	GALA COLOUR RANGE TWO-COLOUR DOOR
RC3 PACKAGE WITH HARDWARE BERGEN OR BLOK	LOCK CYLINDERS CLASS 6, KEYED ALIKE SYSTEM
RC3 PACKAGE WITH HARDWARE PRAGA	OPTIC F – ELECTRONIC VIEWER 2,4"
DOOR SIZE 100E	OPTIC M – ELECTRONIC VIEWER 4,3"
DOOR SHORTENIG (20, 30, 40, 50, 60, 70, 100 mm)	INOX THRESHOLD WITH SEAL H=19 mm
TWO-COLOUR DOOR, TERRA COLOUR RANGE	INOX THRESHOLD WITH SEAL H=32 mm
KNOB-HANDLE	NORWEGIAN WOODEN THRESHOLD WITH SEAL H=19 mm
REED SWITCH	NORWEGIAN WOODEN THRESHOLD WITH ALUMINIUM STRIP AND SEAL H=28 mm
DOOR HEIGHT RAISED 100 mm	NORWEGIAN WOODEN THRESHOLD WITH WOODEN STRIP AND SEAL H=35 mm ¹
DOOR LATCH ^{1 2}	PRE-ASSEMBLED DOOR ⁵
ADDITIONAL LOCK WITH CYLINDER PROTECTION	tedee PRO SET

1 - for door frames extended by 6 mm, with the DPO mounting system
 2 - for door frames with the DPO mounting system, metal doors
 3 - available for COMFORT 60 RC2 / RC3 (30 dB)

4 - not available for door size 80N
 5 - for selected configurations of door frames and thresholds

TERRA COLOUR RANGE

COLOURS OF PLAIN DOORS, DOORS WITH INSERTS, DOORS WITH ELITE PACKAGE (DOOR TRIMS, DOOR LEAVES, THRESHOLDS, DOOR FRAMES, REPLACEABLE PANELS)

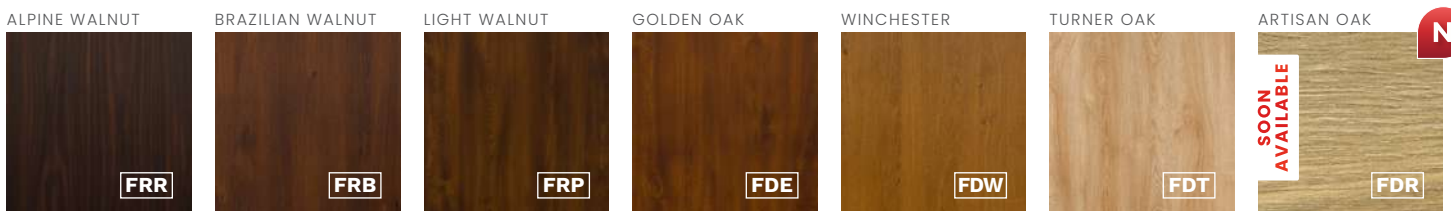

INSERT COLOURS

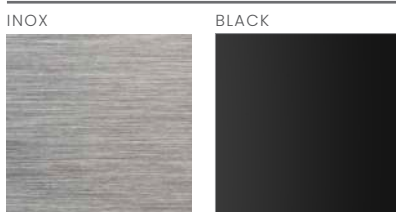

* EXTRA CHARGE

** SET (DOOR LEAF, THRESHOLD, DOOR FRAME, HARDWARE WITH HANDLES, LOCK CYLINDERS)



standard THRESHOLD



extra charge THRESHOLD

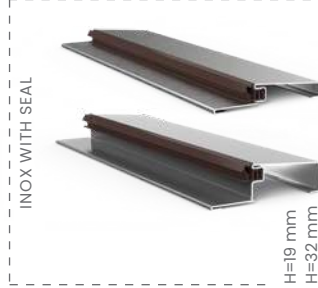

COLOURS
BROWN
LIGHT BROWN
LIGHT



extra charge HARDWARE

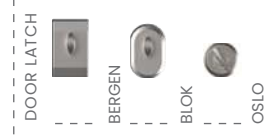

standard HARDWARE

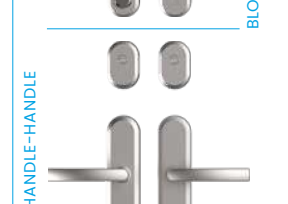
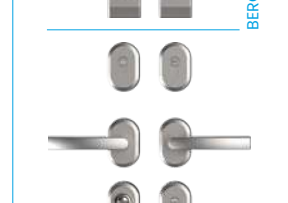

TERRA COLOUR RANGE

COLOURS OF PLAIN DOORS, DOORS WITH INSERTS, DOORS WITH ELITE PACKAGE (DOOR TRIMS, DOOR LEAVES, THRESHOLDS, DOOR FRAMES, REPLACEABLE PANELS)

LIGHT WENGE



WHITENED WENGE

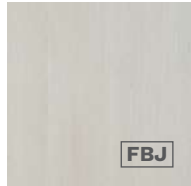

STEEL-GRAY



DARK ANTHRACITE

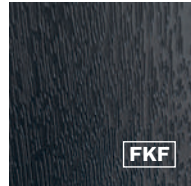

WHITE



ANTHRACITE



BLACK



HARDWARE COLOURS: PRAGA, BERGEN UND BLOK

PLATINUM ANODE



SILVER ANODE



BLACK ANODE



OSLO HARDWARE

SATIN NICKEL



* EXTRA CHARGE



DOOR SIZE	all
DOOR FRAME	FA • FA PORTAL • FD

DOOR TRIMS

SET

FOR ONE SIDE OF THE DOOR

Door trims improve the appearance of the entrance to the apartment. It makes your door stand out among regular doors. It can be applied in GERDA metal doors (PLAIN and with INSERTS) and with ELITE Package.

They are available in sets for one or both door sides.

Door trims (2200 x 80 x 12 mm) – are available with door frames FA, FA PORTAL and FD.

FA ASYMMETRICAL DOOR FRAME WITH SEAL

HORIZONTAL CROSS SECTION

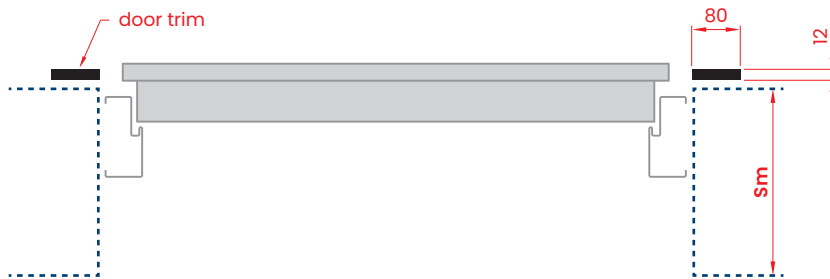



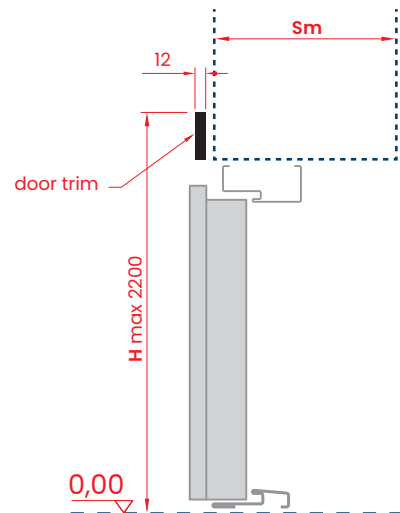





VERTICAL CROSS SECTION

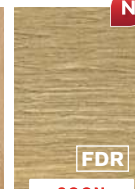

TERRA COLOUR RANGE

DOOR TRIMS, DOOR PORTALS AND STEEL BANDS COLOURS

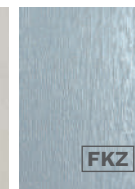
ALPINE WALNUT	BRAZILIAN WALNUT	LIGHT WALNUT	GOLDEN OAK	WINCHESTER	TURNER OAK	ARTISAN OAK	LIGHT WENGE	WHITENED WENGE	STEEL-GRAY
									
FRR	FRB	FRP	FDE	FDW	FDT	FDR	FEJ	FBJ	FKZ

SOON AVAILABLE



DOOR SIZE	all
DOOR FRAME	FA PORTAL • FT PORTAL

DOOR PORTAL

SET

Add up each of the parts **L** – left, **R** – right and **T** – top and **D** – depth, to get the total price for the portal.

Thickness of the portal is 12 mm.

The overall width of the compound is the sum of the widths of the door (outer frame dimension) and width of the right and the left side of the portal. Similarly, the height of the compound is the sum of the door height with frame and the height of the top side of the portal.

Door portals are available with door frames FA PORTAL and FT PORTAL

WALL LINING increments every 10 mm	L	R	T
10 - 100	✓	✓	✓
110 - 150	✓	✓	✓
160 - 200	✓	✓	✓
210 - 250	✓	✓	✓
260 - 300	✓	✓	✓
310 - 350	✓	✓	✓
360 - 400	✓	✓	✓
410 - 450	–	–	✓
460 - 500	–	–	✓
510 - 550	–	–	✓
560 - 600	–	–	✓
FR (fire resistant) board	+40% extra charge		

DEPTH OF THE PORTAL increments every 5 mm	D
50 - 100	✓
105 - 150	✓
155 - 200	✓
205 - 250	✓
255 - 300	✓
305 - 350	✓
355 - 400	✓
–	–
–	–
–	–
–	–
FR (fire resistant) board	+40% extra charge

D DEPTH OF THE PORTAL increments every 5 mm	FA PORTAL FRAME WITH GROOVE in mm	Sm WALL THICKNESS in mm
od 50 do 400	80	od 130 do 480

D DEPTH OF THE PORTAL increments every 5 mm	FT PORTAL FRAME WITH GROOVE in mm W00 PLAIN/ ELITE Package	Sm WALL THICKNESS in mm
od 50 do 400	70/75	od 120/125 do 470/475

TERRA COLOUR RANGE

DOOR TRIMS, DOOR PORTALS AND STEEL BANDS COLOURS

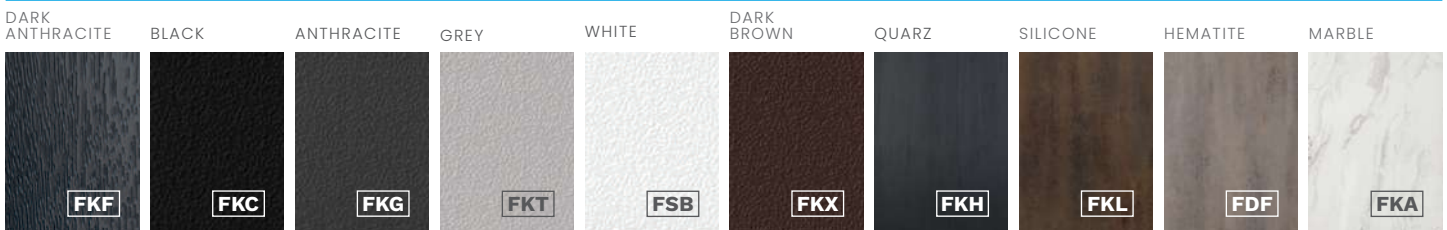

FA PORTAL ASYMMETRICAL DOOR FRAME WITH SEAL AND GROOVE FOR PORTAL INSTALLATION

HORIZONTAL CROSS SECTION

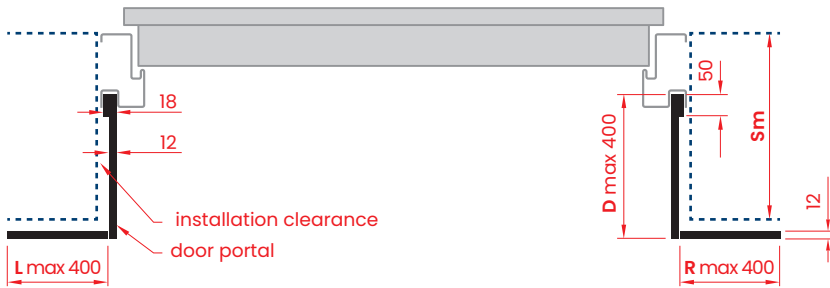

VERTICAL CROSS SECTION

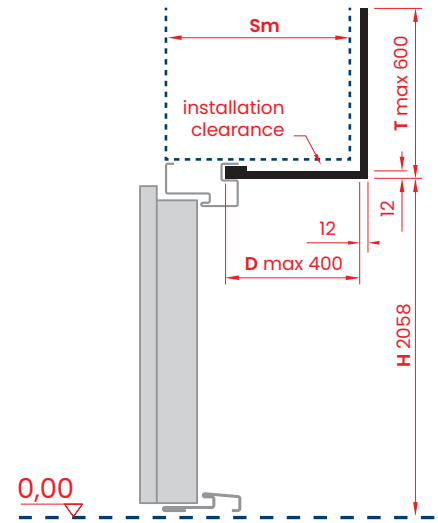

FT PORTAL CORNER FRAME WITH SEAL AND GROOVE FOR PORTAL INSTALLATION

HORIZONTAL CROSS SECTION

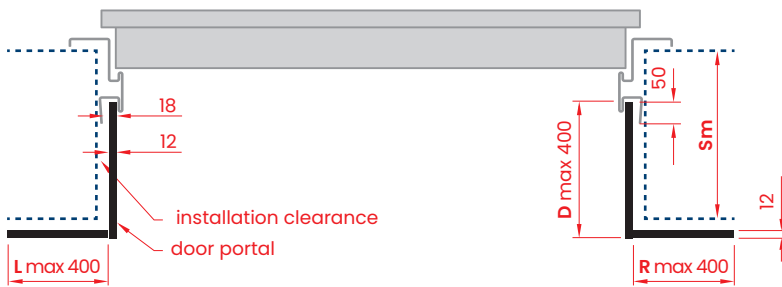

VERTICAL CROSS SECTION

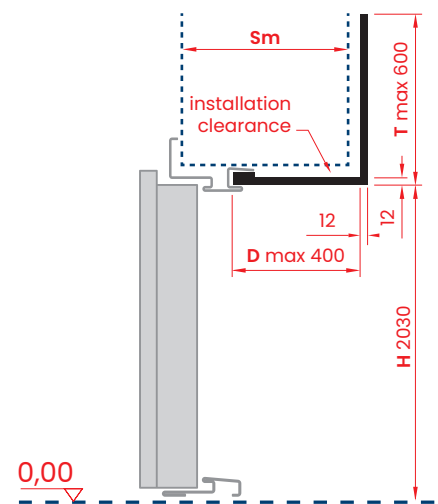

DESCRIPTION

D - depth of the portal (mm)
L - width of wall lining on the left side (mm)
R - width of the wall lining on the right side (mm)
F - diameter from the edge of the wall till the bottom of the groove:

FA PORTAL=80 mm,
 FT PORTAL metalowe=70 mm
 FT PORTAL z PAKIETEM ELITE=75 mm

T - height of the wall lining above the door frame (mm)
H - height of portal's vertical beam (mm)
Sm - Wanddicke (mm)









$$D = Sm - F$$

CAUTION!

Dimensions on the inside of the portal measured from the edge of the wall do not include the thickness of the material.

TERRA COLOUR RANGE

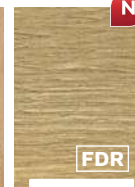
DOOR TRIMS, DOOR PORTALS AND STEEL BANDS COLOURS

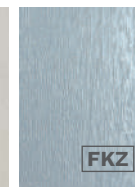
ALPINE WALNUT	BRAZILIAN WALNUT	LIGHT WALNUT	GOLDEN OAK	WINCHESTER	TURNER OAK	ARTISAN OAK	LIGHT WENGE	WHITENED WENGE	STEEL-GRAY
									
FRR	FRB	FRP	FDE	FDW	FDT	FDR	FEJ	FBJ	FKZ

SOON AVAILABLE

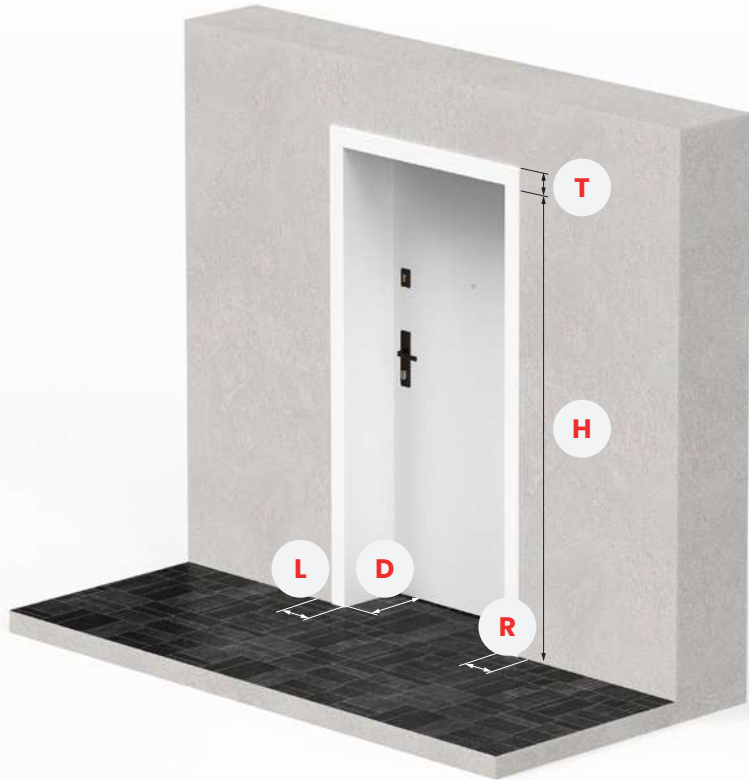

DOOR SIZE	all
DOOR FRAME	FT PORTAL

STEEL BANDS

SET

DOOR FRAME	DOOR SERIES	D 10-mm-Schritte	L,R,T in mm
FT PORTAL	Comfort RC2 / RC3 Premium RC2 / RC3	130 - 230	65
	Comfort RC2 / RC3 Premium RC2 / RC3	240 - 300	65
	Comfort RC2 / RC3 Premium RC2 / RC3	310 - 320	65
	Comfort RC2 / RC3 Premium RC2 / RC3	130 - 230	100
	Comfort RC2 / RC3 Premium RC2 / RC3	240 - 300	100
	Comfort RC2 / RC3 Premium RC2 / RC3	310 - 320	100
	Premium RC2 / RC3 EI30 / EI45 / EI60	130 - 230	65
	Premium RC2 / RC3 EI30 / EI45 / EI60	240 - 300	65
	Premium RC2 / RC3 EI30 / EI45 / EI60	310 - 320	65
	Premium RC2 / RC3 EI30 / EI45 / EI60	130 - 230	100
	Premium RC2 / RC3 EI30 / EI45 / EI60	240 - 300	100
	Premium RC2 / RC3 EI30 / EI45 / EI60	310 - 320	100

FT PORTAL CORNER FRAME WITH SEAL AND GROOVE FOR STEEL BAND INSTALLATION

HORIZONTAL CROSS SECTION

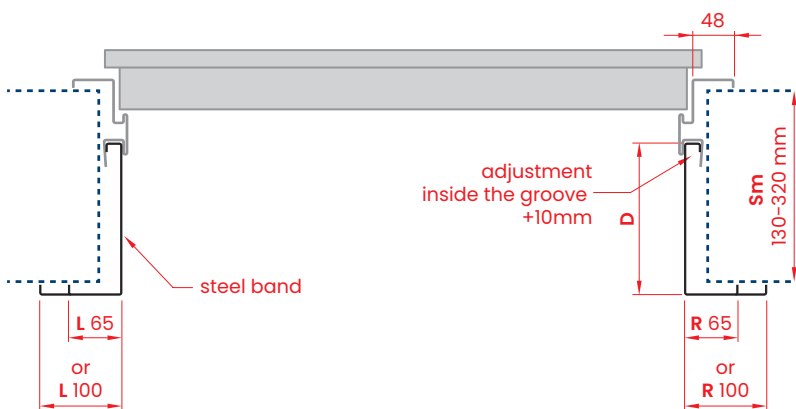

VERTICAL CROSS SECTION

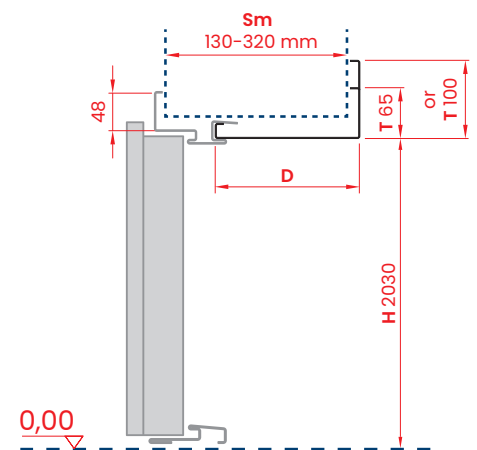

TERRA COLOUR RANGE

DOOR TRIMS, DOOR PORTALS AND STEEL BANDS COLOURS

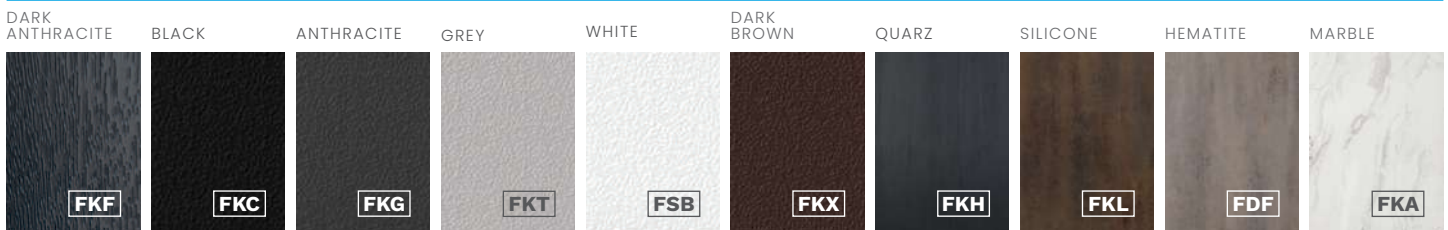

FRR
ALPINE WALNUT
 wood texture
 vertical pattern
 semi gloss

DOOR LEAF
 ELITE PANELS
 DOOR FRAME
 THRESHOLD
 DOOR TRIMS
 DOOR PORTAL
 STEEL BAND

FRB
BRAZILIAN WALNUT
 wood texture
 vertical pattern
 semi gloss

DOOR LEAF
 ELITE PANELS
 DOOR FRAME
 THRESHOLD
 DOOR TRIMS
 DOOR PORTAL
 STEEL BAND

FRP
LIGHT WALNUT
 wood texture
 vertical pattern
 semi gloss

DOOR LEAF
 ELITE PANELS
 DOOR FRAME
 THRESHOLD
 DOOR TRIMS
 DOOR PORTAL
 STEEL BAND

FDE
GOLDEN OAK
 wood texture
 vertical pattern
 semi gloss

DOOR LEAF
 ELITE PANELS
 DOOR FRAME
 THRESHOLD
 DOOR TRIMS
 DOOR PORTAL
 STEEL BAND

FBJ
WHITENED WENGE
 wood texture
 vertical pattern
 semi gloss

DOOR LEAF
 ELITE PANELS
 DOOR FRAME
 THRESHOLD
 DOOR TRIMS
 DOOR PORTAL
 STEEL BAND

FKF
DARK ANTHRACITE
 wood texture
 vertical pattern
 semi gloss

DOOR LEAF
 ELITE PANELS
 DOOR FRAME
 THRESHOLD
 DOOR TRIMS
 DOOR PORTAL
 STEEL BAND

FKZ
STEEL-GRAY
 wood texture
 vertical pattern
 semi gloss

DOOR LEAF
 ELITE PANELS
 DOOR FRAME
 THRESHOLD
 DOOR TRIMS
 DOOR PORTAL
 STEEL BAND

FKX
DARK BROWN
 grain texture
 semi gloss

DOOR FRAME
 DOOR TRIMS
 DOOR PORTAL
 STEEL BAND

FKH
QUARZ
 texture
 semi matte

ELITE PANELS
 DOOR TRIMS
 DOOR PORTAL
 STEEL BAND

FKL
SILIZIUM
 texture
 semi matte

ELITE PANELS
 DOOR TRIMS
 DOOR PORTAL
 STEEL BAND

FDf
HÄMATIT
 texture
 semi matte

ELITE PANELS
 DOOR TRIMS
 DOOR PORTAL
 STEEL BAND

FKA
MARMOR
 smooth
 semi matte

ELITE PANELS
 DOOR TRIMS
 DOOR PORTAL
 STEEL BAND

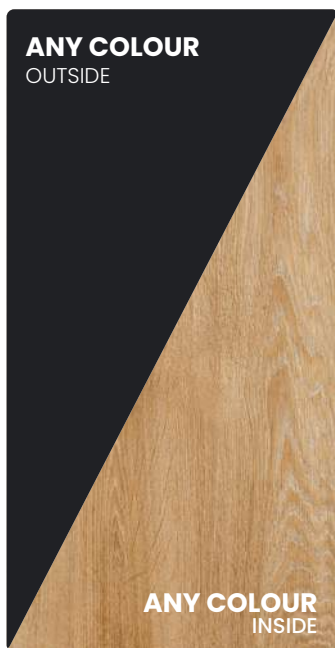
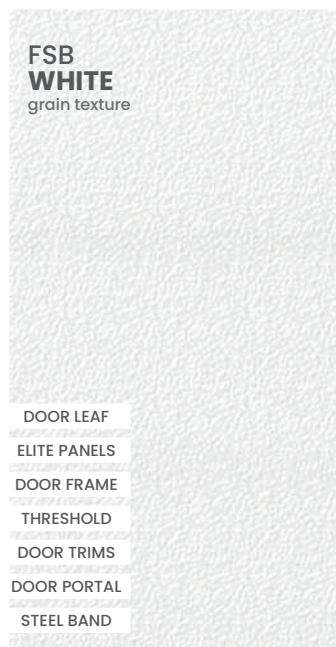

TWO-COLOUR DOOR

To obtain a unique configuration of the door to our apartment, we can combine any two colors from the available TERRA colour range. The outer side of the door leaf, as well as the outer frame, will then have a different color than the inner side. In this way, we can even better match the style of the door to the design of the hall and interior. That option is available with an extra charge. Without extra charges, there is also available to order door leaf in a selected color with a frame in a different color.

www.konfigurator.gerda.pl

You are welcome to use the reliable tool that is the Gerda online door configurator. With its help you can intuitively design a door to suit your needs. In addition, you can immediately see the visualization of your dream door.













HARDWARE

HANDLES AND ESCUTCHEON FOR THE MAIN LOCK

DOOR SERIES				COMFORT 60	PREMIUM 60	PREMIUM 60 E130 E145 E160	STAR 60
	PRAGA	handle-handle	RC2 RC3	✓ ✓	✓	— —	—
	PRAGA	knob-handle	RC2 RC3	✓ ✓	✓	— —	—
	BERGEN	handle-handle	TD200	RC2	✓	✓	—
			TD1000	RC4	—	✓	✓
	BERGEN	knob-handle	TD200	RC2	✓	✓	—
			TD1000	RC4	✓	✓	✓
	BERGEN	handle-handle		✓	✓	✓	—
	BLOK	handle-handle	TD200	RC2	✓	✓	—
			TD1000	RC4	✓	✓	✓
	BLOK	knob-handle	TD200	RC2	✓	✓	—
			TD1000	RC4	✓	✓	✓
	BLOK	handle-handle		✓	✓	✓	—
	OSLO	handle-handle		✓	✓	—	—
	TECHNO	handle-handle		—	—	—	✓
	TECHNO	knob-handle		—	—	—	✓

ADDITIONAL LOCK CYLINDERS

DOOR SERIES				COMFORT 60	PREMIUM 60	PREMIUM 60 E130 E145 E160	STAR 60
	PRAGA	with lock cylinder protection	RC2 RC3	✓	✓	—	—
	PRAGA	without lock cylinder protection		✓	✓	—	—
	BERGEN	with lock cylinder protection	TW300	RC2 RC3	✓	—	—
	BERGEN	without lock cylinder protection		✓	✓	—	—
	BLOK	with lock cylinder protection	TW1000	RC4	—	✓	—
	BLOK	with lock cylinder protection	TW200	RC2	✓	✓	—
	BLOK	without lock cylinder protection		✓	✓	—	—
	OSLO	with lock cylinder protection		RC2	✓	—	✓
	OSLO	without lock cylinder protection		✓	✓	—	—
	DOOR LATCH			✓	✓	—	✓

MORTISE BOLT LOCKS

DOOR SERIES				COMFORT 60	PREMIUM 60	PREMIUM 60 E130 E145 E160	STAR 60
	ZW 500 Premium	additional	Class 6	✓	✓	✓	✓
	ZW 1000 ZM Premium	main	RC2 Class 7	✓	✓	✓	—
	ZW 2000 ZM Premium	main	RC3 Class 6	✓	✓	✓	—
	ZW 3000 ZPS Premium	main	RC4 Class 7	—	✓	✓	—
	ZW 6000 Premium	main	RC4 Class 6	—	—	—	✓
	Premium-Schloss	auxiliary		✓	✓	✓	✓

GERDA ACCESSORIES

DOOR SERIES		COMFORT 60	PREMIUM 60	PREMIUM 60 E130 E145 E160	STAR 60
	wide-angle viewer 50/85	✓	✓	✓	✓
	OPTIC F – electronic viewer 2,4"	✓	✓	✓	✓
	OPTIC M – electronic viewer 4,3"	✓	✓	✓	✓
	hinge caps Ø 18 mm	—	—	—	✓
	3D-hinge caps Ø 16 mm	✓	✓	✓	—
	GT 1500 door closer, standard arm	✓	✓	✓	✓
	GT 1500 door closer, arm with a blockade	✓	✓	✓	✓
	GT 3000 door closer, standard rail	✓	✓	✓	✓
	GT 3000 door closer, rail with a blockade	✓	✓	✓	✓
	laminated threshold with seal H=19 mm, matching door frame colour	✓	✓	✓	✓
	laminated threshold with seal H=32 mm, matching door frame colour	✓	✓	—	✓
	INOX threshold with seal H=19 mm	✓	✓	✓	✓
	INOX threshold with seal H=32 mm	✓	✓	—	✓
	norwegian wooden threshold with seal and aluminium cover H= 19 mm available in 3 colours: brown, light brown, light	✓	✓	✓	✓
	norwegian wooden threshold with seal, aluminium cover and strip H=28 mm available in 3 colours: brown, light brown, light	✓	✓	✓	✓
	norwegian wooden threshold with seal, aluminium cover and wooden strip H=35 mm available in 3 colours: brown, light brown, light	✓	✓	—	✓

ACCESSORIES AND FITTINGS

GERDA ACCESSORIES

DOOR SERIES		COMFORT 60	PREMIUM 60	PREMIUM 60 E130 E145 E160	STAR 60
	fail-secure electric door strike NC (no voltage – closed) RC2 RC3 RC4	✓	✓	–	✓
	fail-secure fire-resistant electric door strike NC (no voltage – closed) RC2 RC3 RC4	–	–	✓	–
	fail-secure electric door strike NO (no voltage – open) RC2 RC3 RC4	✓	✓	–	✓
	fail-secure electric door strike NC (reed switch integrated) RC2 RC3 RC4	✓	✓	–	✓
	fail-secure fire-resistant electric door strike NC (reed switch integrated) RC2 RC3 RC4	–	–	✓	–
	build in reed switch	✓	✓	✓	–
	drop-down threshold build in the door leaf	–	–	✓	–
	laminated closure door trim*	✓	✓	✓	✓
	numeric keypad for access control	✓	✓	✓	✓
	tedee numeric keypad for access control	✓	✓	✓	–
	impulse power supply PSC12015 recommended for doors equipped with an electric strike	✓	✓	✓	✓
	touch-up varnish 12 ml	✓	✓	✓	✓
	cylinder maintenance preparation 25 ml	✓	✓	✓	✓
	cylinder maintenance preparation 100 ml	✓	✓	✓	✓
	cylinder maintenance preparation 400 ml	✓	✓	✓	✓
	door surface maintenance preparation	✓	✓	✓	✓

*LAMINATED CLOSURE DOOR TRIM – necessary when self-shortening the leaf in the range 20, 30, 40, 50, 60, 70 and 20.35 mm and 20 and 35 mm for RC4. Not available for FR (fire-resistant) and ELITE package doors.

LOCK CYLINDERS IN KEY-ALIKED SYSTEM

COMFORT 60 / PREMIUM 60

door opening direction	main lock cylinder size	additional lock cylinder size	number of keys	lock cylinder class
to the inside of the apartment	35/55 cog wheel cam	G55/35 cam	5 + installation keys	Class 5
	35/55 cog wheel cam	G55/35 cam	5 + installation keys	Class 6
to the outside of the apartment (to the corridor)	35/55 cog wheel cam	G35/55 cam	5 + installation keys	Class 5
	35/55 cog wheel cam	G35/55 cam	5 + installation keys	Class 6

PREMIUM 60X WITH ELITE PACKAGE

door opening direction	main lock cylinder size	additional lock cylinder size	number of keys	lock cylinder class
to the inside of the apartment	40/60 cog wheel cam	G60/40 cam	5 + installation keys	Class 5
	40/60 cog wheel cam	G60/40 cam	5 + installation keys	Class 6
to the outside of the apartment (to the corridor)	40/60 cog wheel cam	G40/60 cam	5 + installation keys	Class 5
	40/60 cog wheel cam	G40/60 cam	5 + installation keys	Class 6

STAR 60

door opening direction	main lock cylinder size	additional lock cylinder size	number of keys	lock cylinder class
universal	RIM6000	-	5	Class 6
to the inside of the apartment	-	G55/35 cam	5 + installation keys	Class 5
to the outside of the apartment (to the corridor)	-	G35/55 cam	5 + installation keys	Class 6

STAR 60X WITH ELITE PACKAGE

door opening direction	main lock cylinder size	additional lock cylinder size	number of keys	lock cylinder class
universal	RIM6000	-	5	Class 6
to the inside of the apartment	-	G60/40 cam	5 + installation keys	Class 5
to the outside of the apartment (to the corridor)	-	G40/60 cam	5 + installation keys	Class 6

WKO MOUNTING SYSTEM (ANCHOR+BRACKET)

COMFORT 60

Dimensions in mm

METAL DOOR

DOOR SIZE	A	B	C	D
80N	783	813	2025	2040
80	813	843	2025	2040
90N	883	913	2025	2040
90Z	946	976	2025	2040
100E	1026	1056	2025	2040

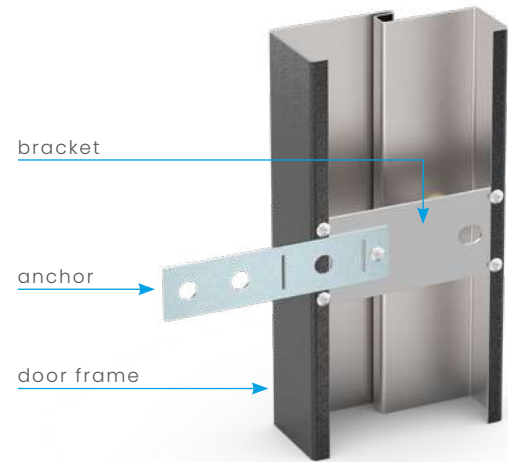

FD SYMMETRICAL DOOR FRAME WITHOUT SEAL

DOOR SIZE	J	K	M	N	CLEAR OPENING	RECOMMENDED MOUNTING CUT-OUT	
					SP	X	Y
80N	764	872	2005	2087	748	902	2093
80	794	902	2005	2087	778	932	2093
90N	864	972	2005	2087	848	1002	2093
90Z	927	1035	2005	2087	911	1065	2093
100E	1007	1115	2005	2087	991	1145	2093

FD

DOOR FRAME PROFILE

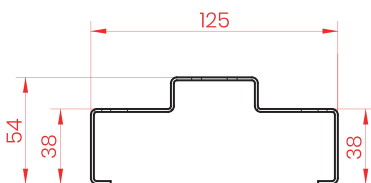

HORIZONTAL CROSS SECTION

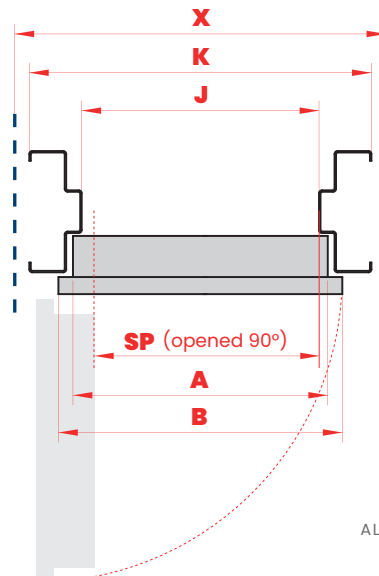

VERTICAL CROSS SECTION

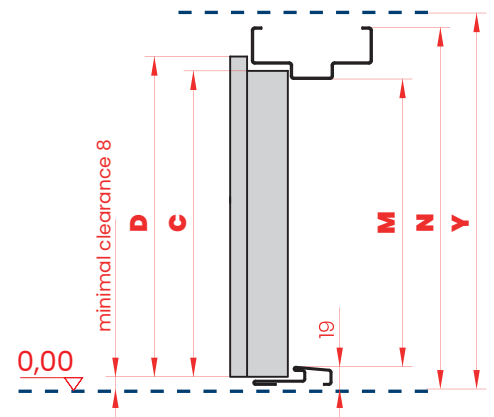

ALL AVAILABLE DOOR FRAMES FOR APARTMENTS ARE INCLUDED IN THE CATALOGUE OF DOOR FRAMES IN THE GEOS SYSTEM

WKO MOUNTING SYSTEM (ANCHOR+BRACKET)

COMFORT 60

Dimensions in mm

METAL DOOR

DOOR SIZE	A	B	C	D
80N	783	813	2025	2040
80	813	843	2025	2040
90N	883	913	2025	2040
90Z	946	976	2025	2040
100E	1026	1056	2025	2040

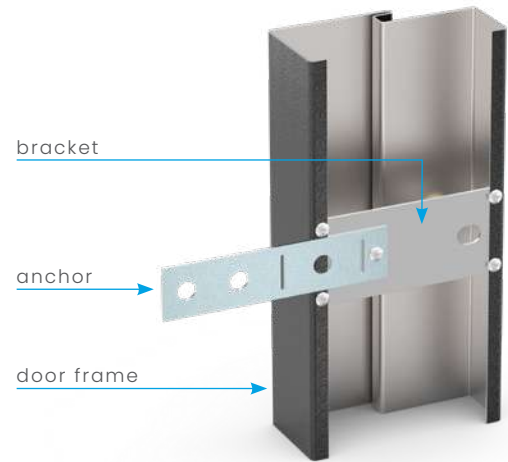

FN CORNER DOOR FRAME WITHOUT SEAL

DOOR SIZE	J	K	L	M	N	O	CLEAR OPENING		RECOMMENDED MOUNTING CUT-OUT	
							SP	X	X'	Y
80N	764	798	872	2005	2041	2078	748	829	847	2056
80	794	828	902	2005	2041	2078	778	859	877	2056
90N	864	898	972	2005	2041	2078	848	929	947	2056
90Z	927	961	1035	2005	2041	2078	911	992	1010	2056
100E	1007	1041	1115	2005	2041	2078	991	1072	1090	2056

1 - dimension of raw installation hole including clearance for deadbolts and fixed bolts caps

FN

DOOR FRAME PROFILE

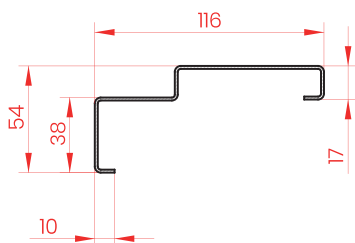

HORIZONTAL CROSS SECTION

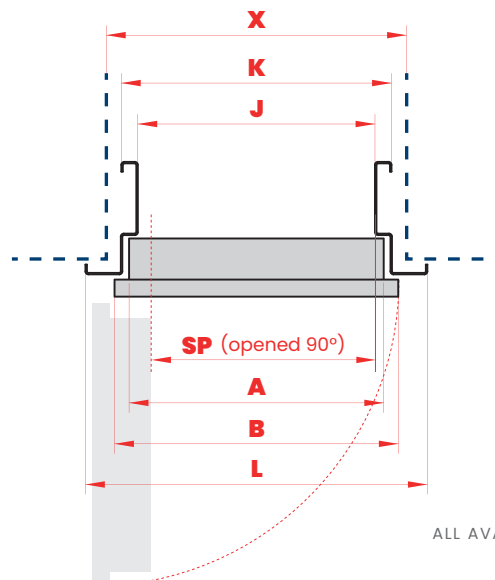

VERTICAL CROSS SECTION

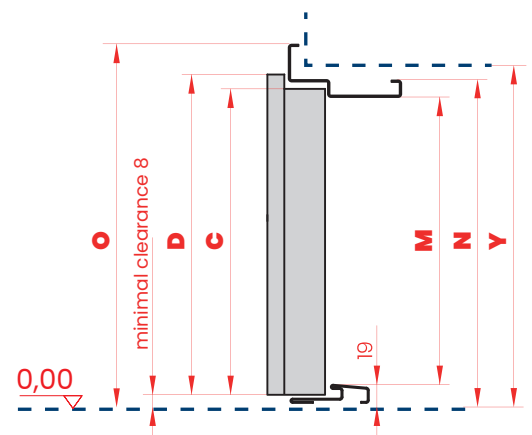

ALL AVAILABLE DOOR FRAMES FOR APARTMENTS ARE INCLUDED IN THE CATALOGUE OF DOOR FRAMES IN THE GEOS SYSTEM

WKO MOUNTING SYSTEM (ANCHOR+BRACKET)

STAR 60 · PREMIUM 60 · COMFORT 60

Dimensions in mm

METAL DOORS				DOORS WITH ELITE PACKAGE				
DOOR SIZE	A	B	C	D	A	B	C	D
80N	783	813	2025	2040	786	816	2025	2040
80	813	843	2025	2040	816	846	2025	2040
90N	883	913	2025	2040	885	915	2025	2040
90E*	926	956	2025	2040	929	959	2025	2040
90Z**	946	976	2025	2040	949	979	2025	2040
100E	1026	1056	2025	2040	1029	1059	2025	2040

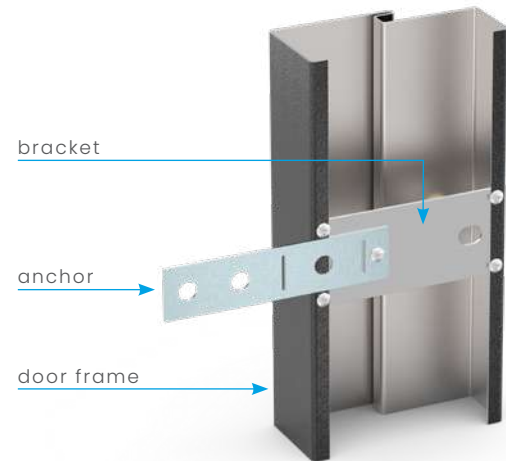

FA ASYMMETRICAL DOOR FRAME WITH SEAL

DOOR SIZE	J	J'	K	K'	M	N	CLEAR OPENING			RECOMMENDED MOUNTING CUT-OUT		
							SP	SP'	SP ²	X	X'	Y
80N	765	761	872	868	2005	2087	748	744	742	902	898	2093
80	795	791	902	898	2005	2087	778	774	772	932	928	2093
90N	865	861	972	968	2005	2087	848	844	842	1002	998	2093
90E*	908	-	1015	-	2005	2087	891	887	885	1045	-	2093
90Z**	928	924	1035	1031	2005	2087	911	907	905	1065	1061	2093
100E	1008	1004	1115	1111	2005	2087	991	987	985	1145	1141	2093

* 90E - size available only for STAR 60 doors

** 90Z - size available for COMFORT 60 and PREMIUM 60 doors

1 - for metal doors with FR (Fire Resistance) package

2 - for doors with ELITE Package

FA

DOOR FRAME PROFILE

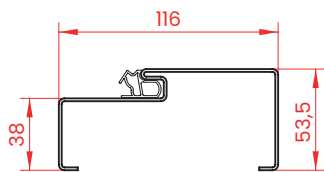

HORIZONTAL CROSS SECTION

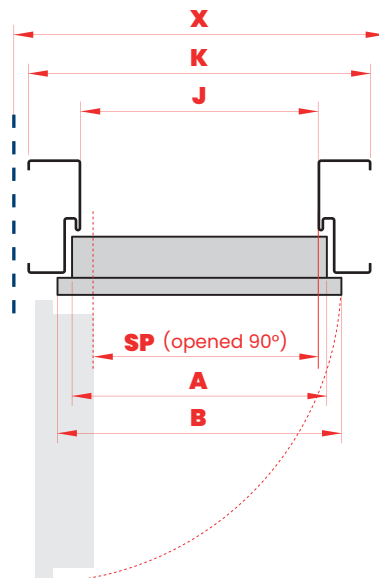

VERTICAL CROSS SECTION

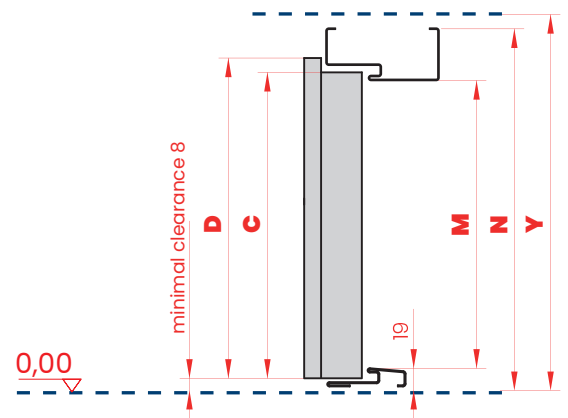

ALL AVAILABLE DOOR FRAMES FOR APARTMENTS ARE INCLUDED IN THE CATALOGUE OF DOOR FRAMES IN THE GEOS SYSTEM

WKO MOUNTING SYSTEM (ANCHOR+BRACKET)

STAR 60 · PREMIUM 60 · COMFORT 60

Dimensions in mm

METAL DOORS					DOORS WITH ELITE PACKAGE			
DOOR SIZE	A	B	C	D	A	B	C	D
80N	783	813	2025	2040	786	816	2025	2040
80	813	843	2025	2040	816	846	2025	2040
90N	883	913	2025	2040	885	915	2025	2040
90E*	926	956	2025	2040	929	959	2025	2040
90Z**	946	976	2025	2040	949	979	2025	2040
100E	1026	1056	2025	2040	1029	1059	2025	2040

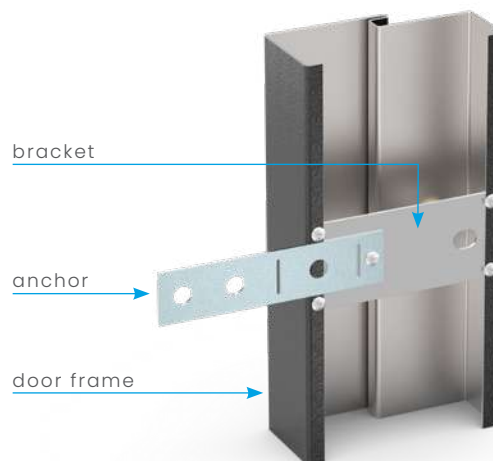

FT CORNER DOOR FRAME WITH SEAL

DOOR SIZE	J	J'	K	K'	L	L'	M	N	O	CLEAR OPENING			RECOMMENDED MOUNTING CUT-OUT		
										SP	SP'	SP ²	X	X'	Y
80N	765	761	799	795	872	868	2005	2041	2087	748	744	742	829/847 ³	825/843 ³	2057
80	795	791	829	825	902	898	2005	2041	2087	778	774	772	859/877 ³	855/873 ³	2057
90N	865	861	899	895	972	968	2005	2041	2087	848	844	842	929/947 ³	925/943 ³	2057
90E*	908	-	942	-	1015	-	2005	2041	2087	891	887	885	972/990 ³	-	2057
90Z**	928	924	962	958	1035	1031	2005	2041	2087	911	907	905	992/1010 ³	988/1006 ³	2057
100E	1008	1004	1042	1038	1115	1111	2005	2041	2087	991	987	985	1072/1090 ³	1068/1086 ¹	2057

* 90E - size available only for STAR 60 doors

** 90Z - size available for COMFORT 60 and PREMIUM 60 doors

1 - for metal doors with FR (Fire Resistance) package

2 - for doors with ELITE Package

3 - dimension of raw installation hole including clearance for deadbolts and fixed bolts caps

FT

DOOR FRAME PROFILE

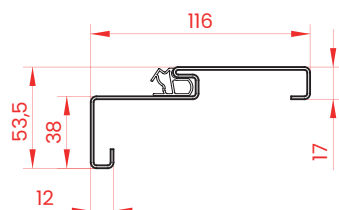

HORIZONTAL CROSS SECTION

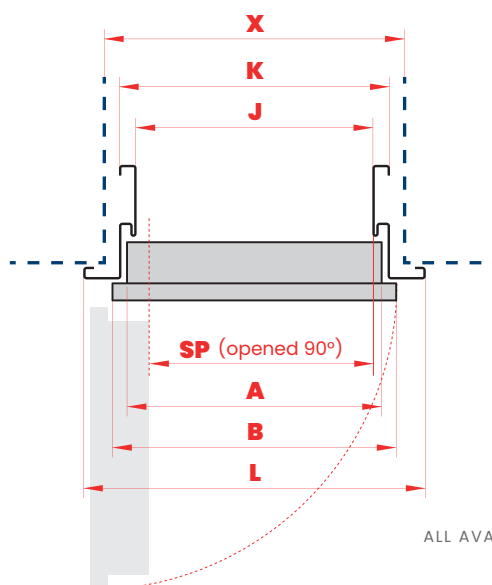

VERTICAL CROSS SECTION

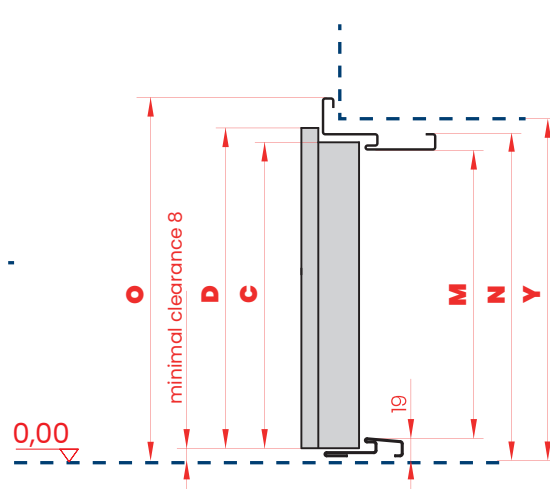

ALL AVAILABLE DOOR FRAMES FOR APARTMENTS ARE INCLUDED IN THE CATALOGUE OF DOOR FRAMES IN THE GEOS SYSTEM

WKO MOUNTING SYSTEM (ANCHOR+BRACKET)

STAR 60 · PREMIUM 60 · COMFORT 60

Dimensions in mm

METAL DOORS					DOORS WITH ELITE PAKAGE			
DOOR SIZE	A	B	C	D	A	B	C	D
80N	783	813	2025	2040	786	816	2025	2040
80	813	843	2025	2040	816	846	2025	2040
90N	883	913	2025	2040	885	915	2025	2040
90E*	926	956	2025	2040	929	959	2025	2040
90Z**	946	976	2025	2040	949	979	2025	2040
100E	1026	1056	2025	2040	1029	1059	2025	2040

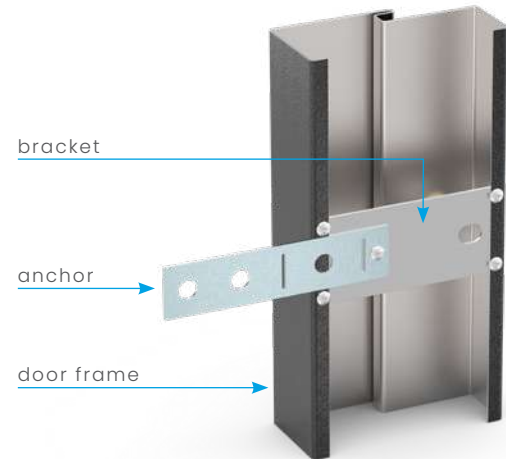

FA PORTAL ASYMMETRICAL DOOR FRAME WITH SEAL AND GROOVE FOR PORTAL INSTALLATION

DOOR SIZE	J	J'	K	K'	M	N	CLEAR OPENING			RECOMMENDED MOUNTING CUT-OUT		
							SP	SP'	SP ²	X	X'	Y
80N	765	761	872	868	2005	2087	748	744	742	902	898	2093
80	795	791	902	898	2005	2087	778	774	772	932	928	2093
90N	865	861	972	968	2005	2087	848	844	842	1002	998	2093
90E*	908	-	1015	-	2005	2087	891	-	885	1045	-	2093
90Z**	928	924	1035	1031	2005	2087	911	907	905	1065	1061	2093
100E	1008	1004	1115	1111	2005	2087	991	987	985	1145	1141	2093

* 90E - size available only for STAR 60 doors

** 90Z - size available for COMFORT 60 and PREMIUM 60 doors

1 - for metal doors with FR (Fire Resistance) package

2 - for doors with ELITE Package

FA PORTAL

DOOR FRAME PROFILE

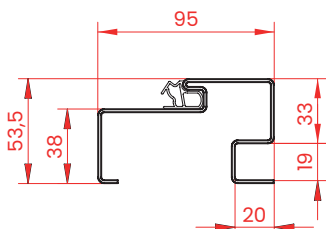

HORIZONTAL CROSS SECTION

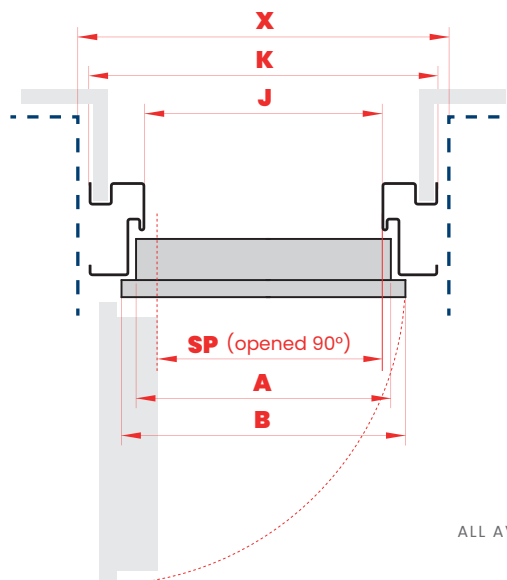

VERTICAL CROSS SECTION

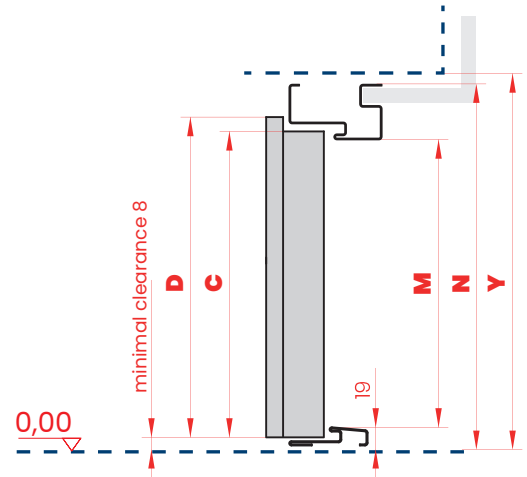

ALL AVAILABLE DOOR FRAMES FOR APARTMENTS ARE INCLUDED IN THE CATALOGUE OF DOOR FRAMES IN THE GEOS SYSTEM

WKO MOUNTING SYSTEM (ANCHOR+BRACKET)

STAR 60 · PREMIUM 60 · COMFORT 60

Dimensions in mm

DOOR SIZE	METAL DOORS				DOORS WITH ELITE PAKAGE			
	A	B	C	D	A	B	C	D
80N	783	813	2025	2040	786	816	2025	2040
80	813	843	2025	2040	816	846	2025	2040
90N	883	913	2025	2040	885	915	2025	2040
90E*	926	956	2025	2040	929	959	2025	2040
90Z**	946	976	2025	2040	949	979	2025	2040
100E	1026	1056	2025	2040	1029	1059	2025	2040

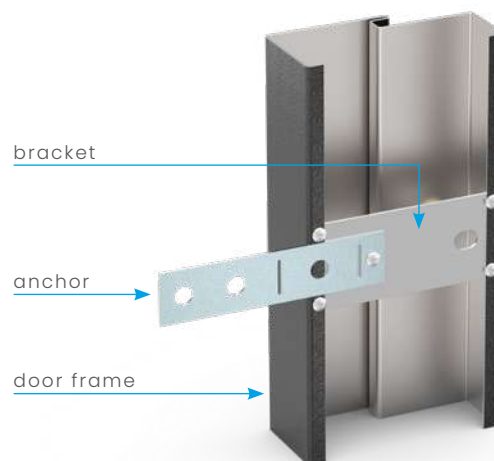

FT PORTAL CORNER DOOR FRAME WITH SEAL AND GROOVE FOR PORTAL INSTALLATION

DOOR SIZE	J	J'	K	K'	L	L'	M	N	O	U ²	U ³	CLEAR OPENING			RECOMMENDED MOUNTING CUT-OUT		
												SP	SP ¹	SP ²	X	X'	Y
80N	765	761	821	817	892	888	2005	2052	2088	101	95	748	744	742	857	853	2070
80	795	791	851	847	922	918	2005	2052	2088	101	95	778	774	772	887	883	2070
90N	865	861	921	917	992	988	2005	2052	2088	101	95	848	844	842	957	953	2070
90E*	908	-	964	-	1035	-	2005	2052	2088	101	95	891	887	885	1000	-	2070
90Z**	928	924	984	980	1055	1051	2005	2052	2088	101	95	911	907	905	1020	1016	2070
100E	1008	1004	1064	1060	1135	1131	2005	2052	2088	101	95	991	987	985	1100	1096	2070

* 90E - size available only for STAR 60 doors

** 90Z - size available for COMFORT 60 and PREMIUM 60 doors

1 - for metal doors with FR (Fire Resistance) package EI30

2 - for doors with ELITE Package

3 - for metal doors

FT PORTAL

DOOR FRAME PROFILE

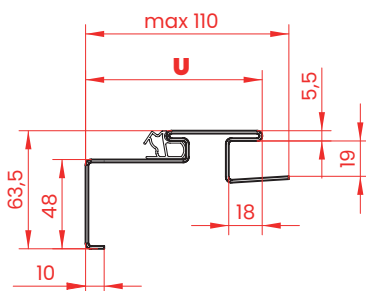

HORIZONTAL CROSS SECTION

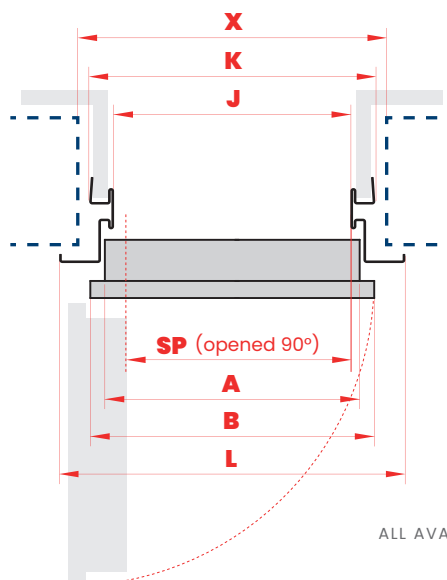

VERTICAL CROSS SECTION

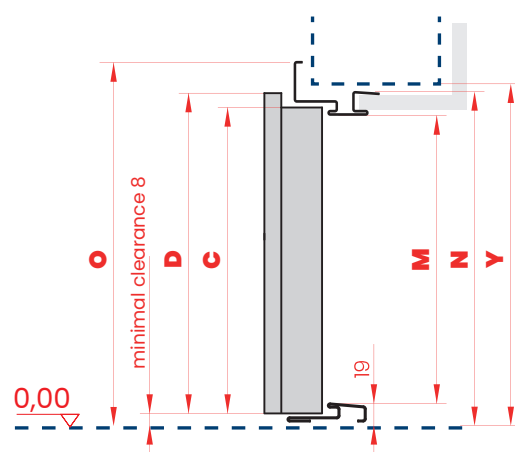

ALL AVAILABLE DOOR FRAMES FOR APARTMENTS ARE INCLUDED IN THE CATALOGUE OF DOOR FRAMES IN THE GEOS SYSTEM

DPO MOUNTING SYSTEM (FRAME DOWEL JOINT)

PREMIUM 60 · COMFORT 60

Dimensions in mm

METAL DOORS

DOOR SIZE	A	B	C	D
80N	783	813	2025	2040
80	813	843	2025	2040
90N	883	913	2025	2040
90Z*	946	976	2025	2040
100E	1026	1056	2025	2040

mounting hole for the dowel

door frame

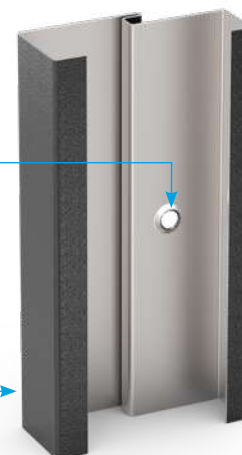

FD SYMMETRICAL DOOR FRAME WITHOUT SEAL

DOOR SIZE	J	K	M	N ¹	N ²	CLEAR OPENING	RECOMMENDED MOUNTING CUT-OUT		
						SP	X	Y ¹	Y ²
80N	764	860	2005	2072	2078	748	890	2085	2091
80	794	890	2005	2072	2078	778	920	2085	2091
90N	864	960	2005	2072	2078	848	990	2085	2091
90Z*	927	1023	2005	2072	2078	911	1053	2085	2091
100E	1007	1103	2005	2072	2078	991	1133	2085	2091

* 90Z - size available for COMFORT 60 and PREMIUM 60 doors

1 - for thresholds: norwegian H=28 mm, H=19 mm and laminated H=19 mm

2 - for thresholds: norwegian H=35 mm and laminated H=32 mm

FD

DOOR FRAME PROFILE

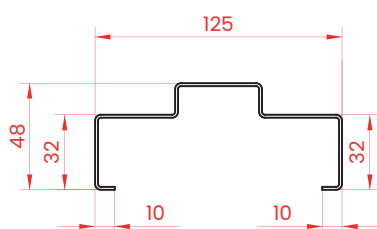

HORIZONTAL CROSS SECTION

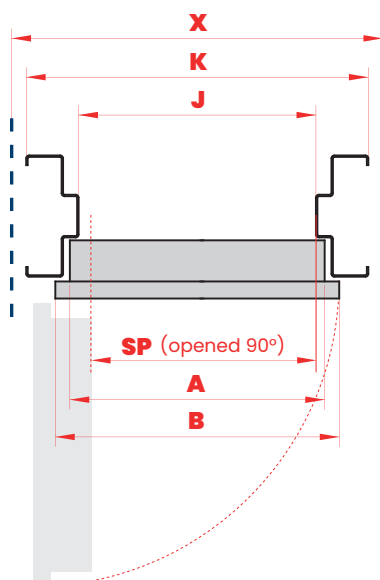

VERTICAL CROSS SECTION

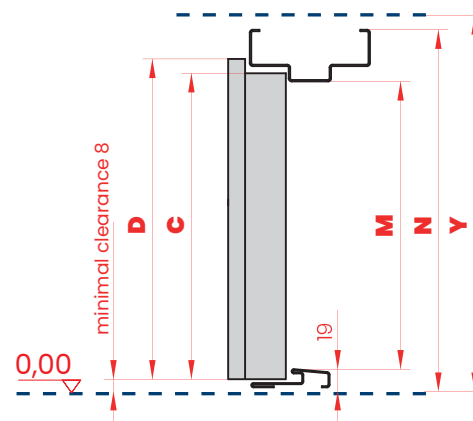

ALL AVAILABLE DOOR FRAMES FOR APARTMENTS ARE INCLUDED IN THE CATALOGUE OF DOOR FRAMES IN THE GEOS SYSTEM

DPO MOUNTING SYSTEM (FRAME DOWEL JOINT)

PREMIUM 60 · COMFORT 60

Dimensions in mm

METAL DOORS

DOOR SIZE	A	B	C	D
80N	783	813	2025	2040
80	813	843	2025	2040
90N	883	913	2025	2040
90Z*	946	976	2025	2040
100E	1026	1056	2025	2040

mounting hole for
the dowel

door frame

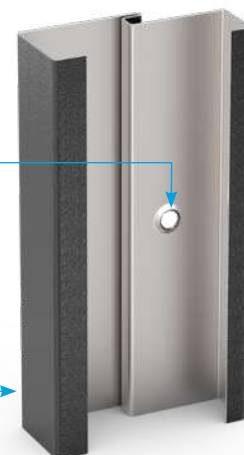

FN CORNER DOOR FRAME WITHOUT SEAL

DOOR SIZE	J	K	L	M	N ¹	N ²	O ¹	O ²	CLEAR OPENING	RECOMMENDED MOUNTING CUT-OUT		
									SP	X	Y ¹	Y ²
80N	764	798	872	2005	2041	2047	2078	2084	748	829	2056	2061
80	794	828	902	2005	2041	2047	2078	2084	778	859	2056	2061
90N	864	898	972	2005	2041	2047	2078	2084	848	929	2056	2061
90Z*	927	961	1035	2005	2041	2047	2078	2084	911	992	2056	2061
100E	1007	1041	1115	2005	2041	2047	2078	2084	991	1072	2056	2061

* 90Z - size available for COMFORT 60 and PREMIUM 60 doors

1 - for thresholds: norwegian H=28 mm, H=19 mm and laminated H=19 mm

2 - for thresholds: norwegian H=35 mm and laminated H=32 mm

FN

DOOR FRAME PROFILE

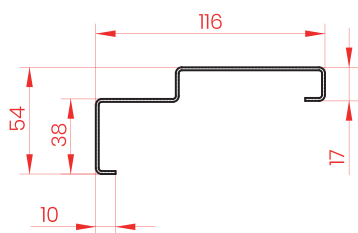

HORIZONTAL CROSS SECTION

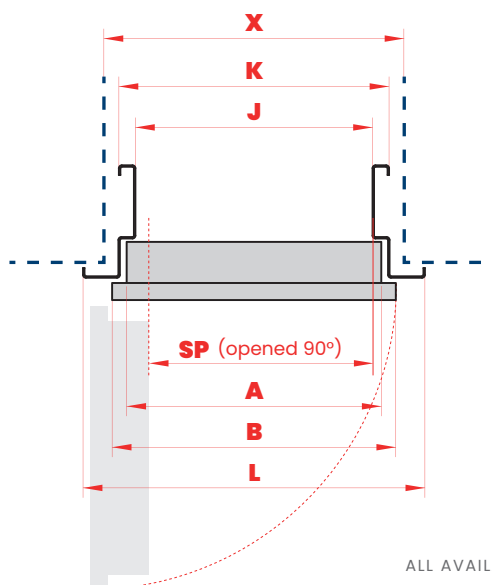

VERTICAL CROSS SECTION

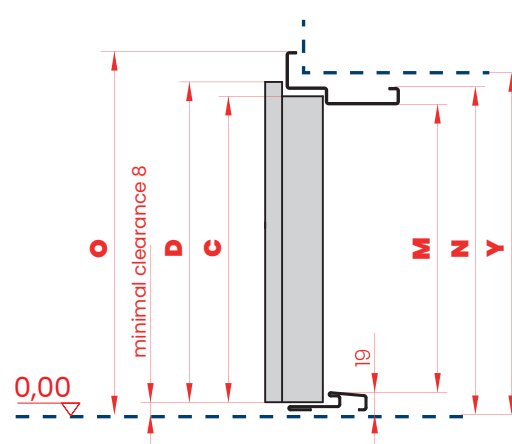

ALL AVAILABLE DOOR FRAMES FOR APARTMENTS ARE INCLUDED IN THE
CATALOGUE OF DOOR FRAMES IN THE GEOS SYSTEM

DPO MOUNTING SYSTEM (FRAME DOWEL JOINT)

PREMIUM 60 · COMFORT 60

Dimensions in mm

METAL DOORS

DOOR SIZE	A	B	C	D
80N	783	813	2025	2040
80	813	843	2025	2040
90N	883	913	2025	2040
90Z*	946	976	2025	2040
100E	1026	1056	2025	2040

mounting hole for the dowel

door frame



FA ASYMMETRICAL DOOR FRAME WITH SEAL

DOOR SIZE	J	K	M	N ¹	N ²	CLEAR OPENING	RECOMMENDED MOUNTING CUT-OUT		
						SP	X	Y ¹	Y ²
80N	765	861	2005	2072	2078	748	890	2085	2091
80	795	891	2005	2072	2078	778	920	2085	2091
90N	865	961	2005	2072	2078	848	990	2085	2091
90Z*	928	1024	2005	2072	2078	911	1053	2085	2091
100E	1008	1104	2005	2072	2078	991	1133	2085	2091

* 90Z - size available for COMFORT 60 and PREMIUM 60 doors

1 - for thresholds: norwegian H=28 mm, H=19 mm and laminated H=19 mm

2 - for thresholds: norwegian H=35 mm and laminated H=32 mm

FA

DOOR FRAME PROFILE

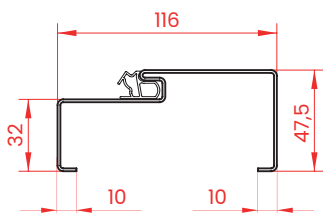

HORIZONTAL CROSS SECTION

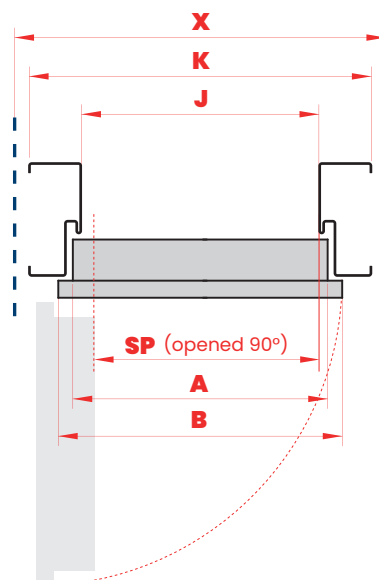

VERTICAL CROSS SECTION

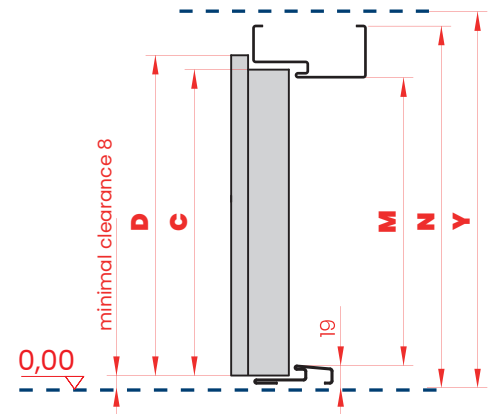

ALL AVAILABLE DOOR FRAMES FOR APARTMENTS ARE INCLUDED IN THE CATALOGUE OF DOOR FRAMES IN THE GEOS SYSTEM

DPO MOUNTING SYSTEM (FRAME DOWEL JOINT)

PREMIUM 60 · COMFORT 60

Dimensions in mm

METAL DOORS

DOOR SIZE	A	B	C	D
80N	783	813	2025	2040
80	813	843	2025	2040
90N	883	913	2025	2040
90Z*	946	976	2025	2040
100E	1026	1056	2025	2040

mounting hole for
the dowel

door frame

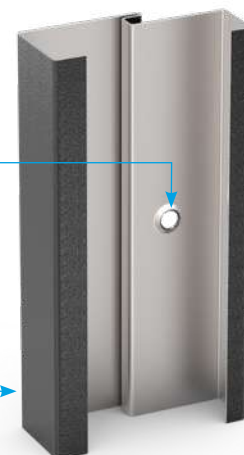

FT CORNER DOOR FRAME WITH SEAL

DOOR SIZE	J	K	L	M	N ¹	N ²	O	CLEAR OPENING	RECOMMENDED MOUNTING CUT-OUT		
								SP	X	Y ¹	Y ²
80N	765	799	872	2005	2041	2047	2078	748	829	2056	2061
80	795	829	902	2005	2041	2047	2078	778	859	2056	2061
90N	865	899	972	2005	2041	2047	2078	848	929	2056	2061
90Z*	928	962	1035	2005	2041	2047	2078	911	992	2056	2061
100E	1008	1042	1115	2005	2041	2047	2078	991	1072	2056	2061

* 90Z - size available for COMFORT 60 and PREMIUM 60 doors

1 - for thresholds: norwegian H=28 mm, H=19 mm and laminated H=19 mm

2 - for thresholds: norwegian H=35 mm and laminated H=32 mm

FT

DOOR FRAME PROFILE

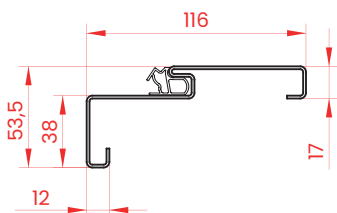

HORIZONTAL CROSS SECTION

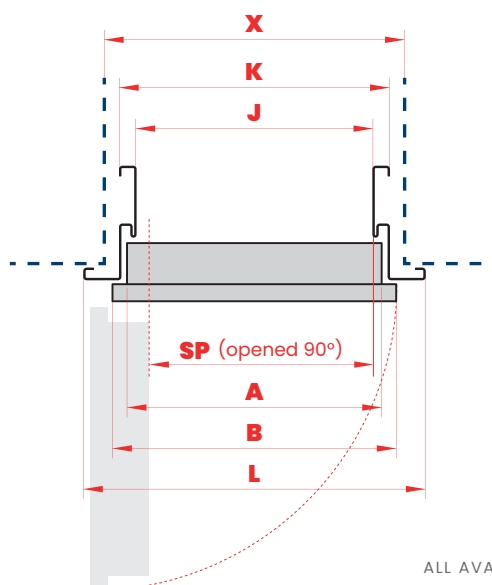

VERTICAL CROSS SECTION

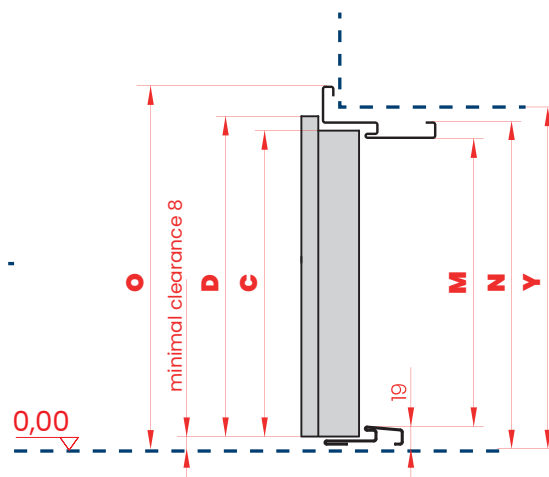

ALL AVAILABLE DOOR FRAMES FOR APARTMENTS ARE INCLUDED IN THE
CATALOGUE OF DOOR FRAMES IN THE GEOS SYSTEM

GERDA®

Gerda Sp. z o.o.

Sokołów, ul. Sokołowska 49
05-806 Komorów
POLAND
Phone (+48 22) 329 10 30

e-mail: export@gerda.pl

www.gerda.pl/en/

This catalogue does not constitute an offer under the provisions of law and is merely informational.

Gerda Sp. z o.o., committed to continuously improving its products and services, reserves the right (without prior notice) to introduce changes to products that, due to the printing material preparation process, may not be included in this material.

Despite all the effort and care in controlling the presented content, substantial or printing errors may occur.

Colours presented herein may differ from the original due to different colour reproduction technique in the printing process. The owner of the copyright for this catalogue, as well as Gerda Sp. z o.o. logotypes and graphics, is Gerda Sp. z o.o.

It is prohibited to copy or distribute any content and material without the prior consent of Gerda Sp. z o.o.

Distributor:

