

GERDA®

PREMIUM DOOR MANUFACTURER

HOUSE DOORS

THERMO PRIME
THERMO PREMIUM
OPTIMA

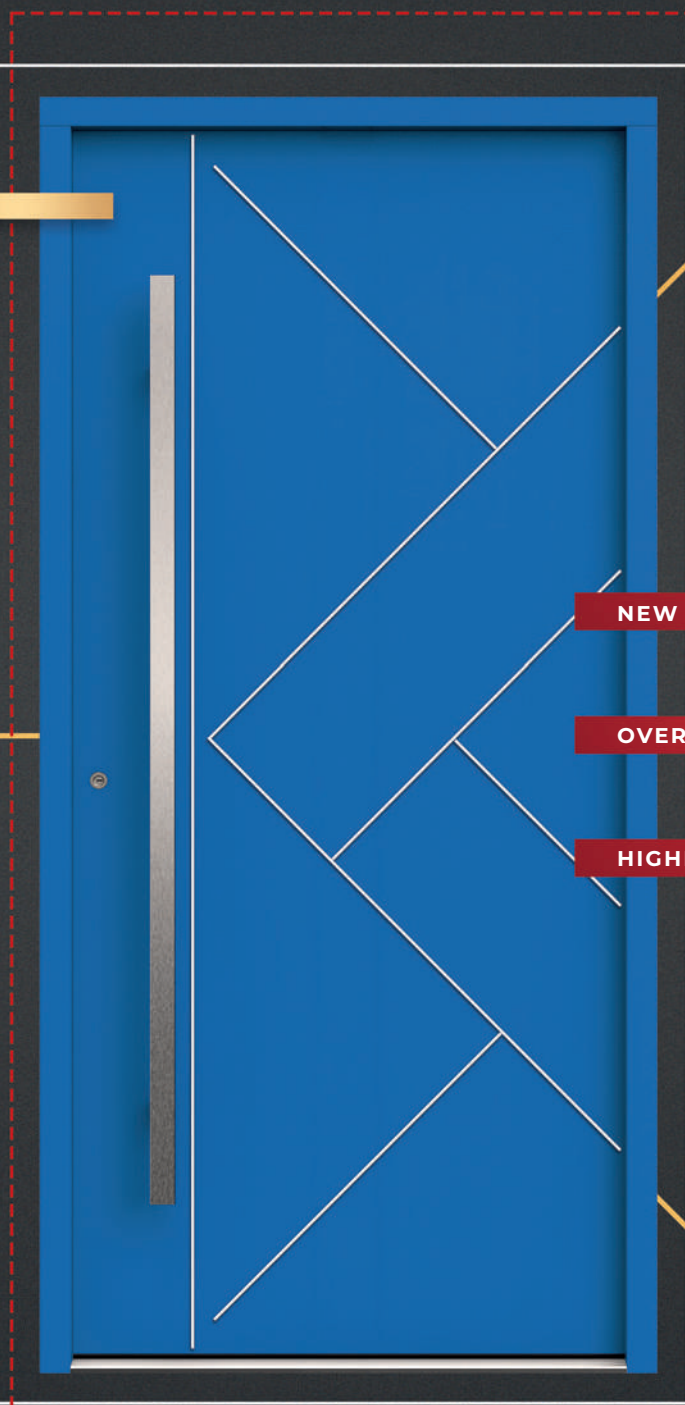

NEW DESIGN AND TECHNOLOGIES

OVER 35 YEARS TOGETHER

HIGHEST QUALITY STANDARDS

EDITION 2.2024



DOORS



Our door frame and leaf solutions are perfect even for the most demanding facilities. Panel and metal doors in our offer feature superior durability, functionality (e.g. easy removal and replacement of a door panel) and the freedom of arrangement.

GATES



All garage gates in our offer comply with European standards. GERDA gates are fitted with comprehensive protection systems with no EXTRA CHARGE.

The "Trend" gate range is an economic but durable and functional solution, perfect for developer facilities.

The "Classic" gate range ensure very good thermal insulation, among others by means of 45-mm thick warm panels. Perfect for buildings with high energy efficiency requirements.

LOCKS AND FITTINGS



Security first. Heat-treated inner die casts or steel plates ensure high resistance to burglary. Hardened tumbler insert cover protects against wrenching off and prevents drilling.

The MASTER KEY system is a solution dedicated for commercial facilities. A single key may be used to open a pre-determined number of locks. This way, moving around the facility is quick and easy, while zone and room access management is very comfortable.

ALUMINUM JOINERY



GERDA also offers aluminum joinery. We build partition walls, doors, windows, shop windows and both indoor and outdoor spatial installations, also in fire-resistant and smoke-tight or high burglary-resistant versions.

TURN YOUR SMARTPHONE INTO A SMART DOOR LOCK



OPEN DOORS WITH YOUR SMARTPHONE

Open and close doors and monitor door lock status from any place around the world. With the automatic opening feature, you don't need to take your phone out from your purse or pocket. The lock will detect your presence and let you in. The self-locking feature works based on the same principle.

SET

tedee PRO SMARTLOCK + tedee BRIDGE + CLASS 6 LOCK CYLINDER

HIGH-PERFORMANCE BATTERY

Gerda engineers, in collaboration with the South Korean Research Institute, have developed a small dedicated high-performance battery. It powers the mechanism for six months of operation. And when in need of recharging, the lock will let you know as you can charge the battery overnight.

SAFETY WARRANTY

The lock actuating mechanism is an innovative, patented design developed by Gerda engineers. The software was created by Tedee IoT experts. An intuitive app lets you keep track of who and when has locked or unlocked the door. It also offers a virtual key allocation feature.



CLASS 6 LOCK CYLINDERS INCLUDED

- ✓ ANTI-BURGLARY TUMBLER LOCK INSERT. NEW LOCK INSERT DESIGN SECURED AGAINST 'LOCK BUMPING', WITH EFFECTIVE DRILL OPENING PROTECTION.

INSTALL A TEDEE LOCK

- ✓ SLIDE THE LOCK ONTO A GERDA INSERT, ADJUST THE LOCK POSITION AND SECURE IT WITH ONE BOLT. INSTALLATION TAKES NO MORE THAN TWO MINUTES. INSPECT TO SEE WHETHER THE BOLTS SLIDE UPON TURNING THE KNOB.

INSTALL THE SMARTPHONE APP

- ✓ DOWNLOAD THE **tedee** APP FROM APPLE STORE OR GOOGLE PLAY. SIGN UP AND ACTIVATE YOUR BLUE-TOOTH, LOCATION SERVICE AND INTERNET ACCESS. ADD YOUR LOCK AND ENTER THE ACTIVATION CODE.

CONNECT THE BRIDGE

- ✓ FIND A FREE POWER SOCKET NEXT TO THE **tedee** LOCK AND PLUG THE BRIDGE IN. THIS WILL ENABLE YOU TO CONTROL THE LOCK OVER THE INTERNET FROM WHEREVER YOU ARE.

TERRA

colour range of laminates



The available range of laminate colours can be found on page 96 of the Catalogue, in the visual configurator and in the Showrooms.

The range of lacquered RAL colours is available in the visual configurator and in the Showrooms.

INSPIRING

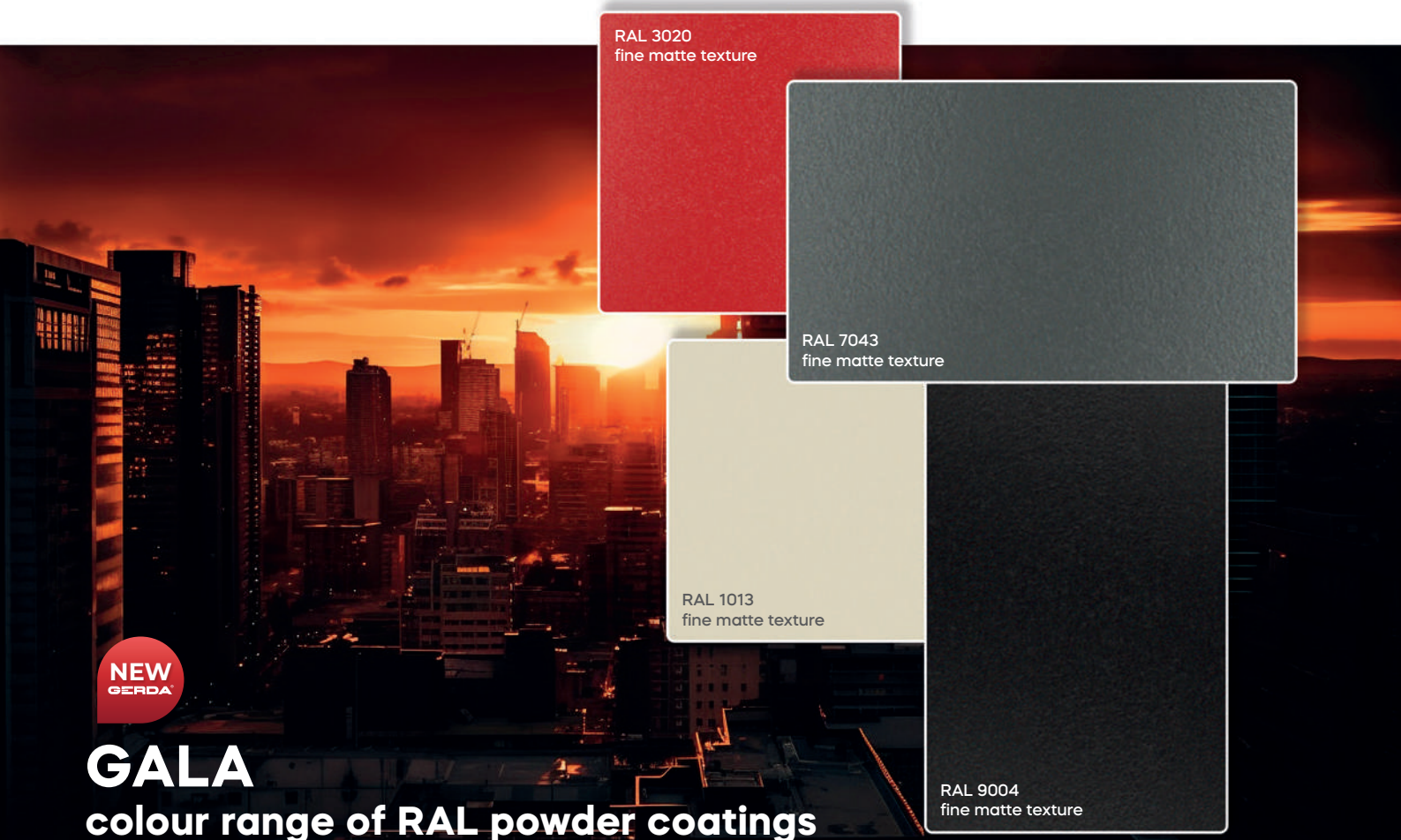

GALA

colour range of RAL powder coatings

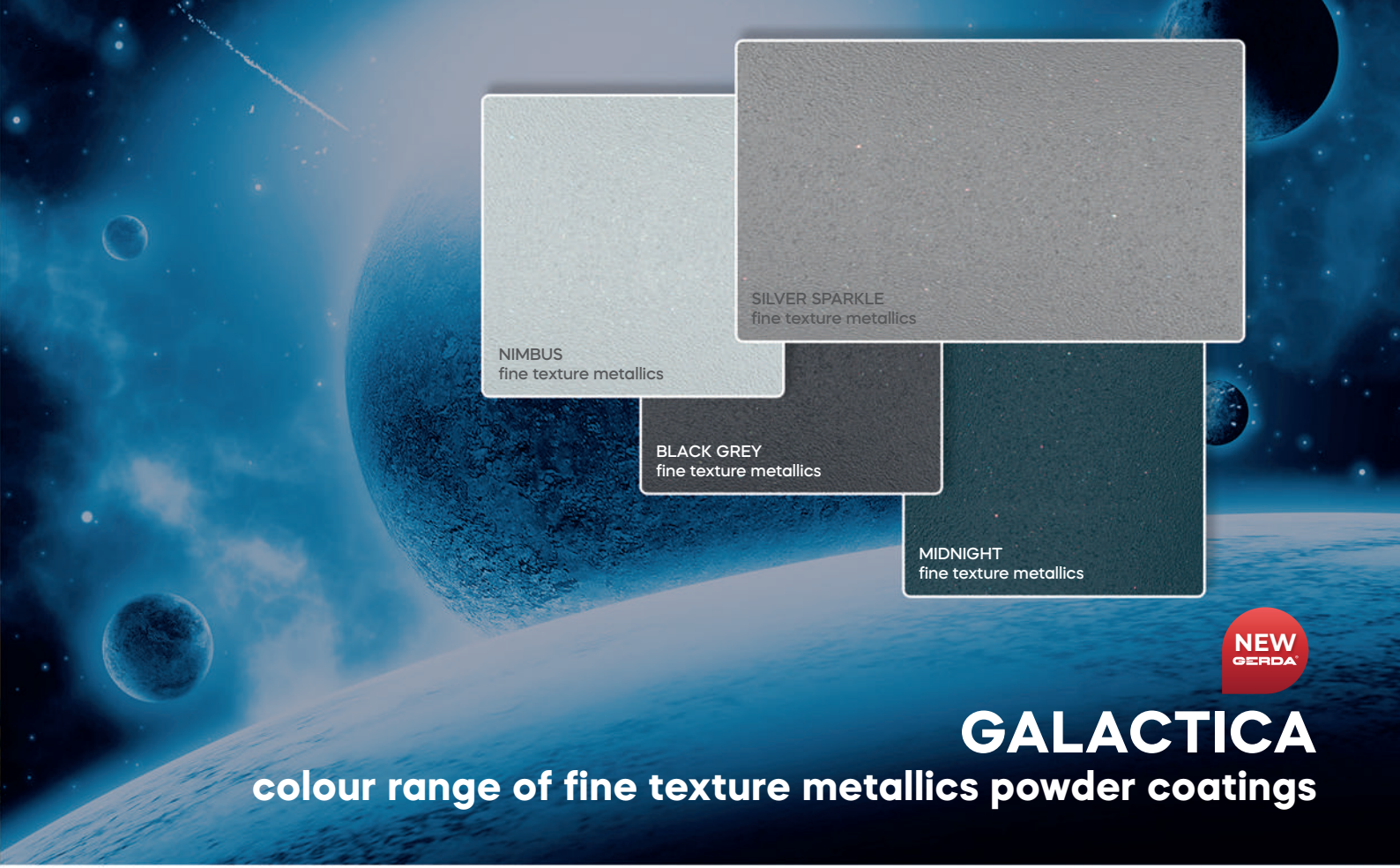

GALACTICA

colour range of fine texture metallics powder coatings

COLOURS

A range of metallics and 3D effect powder coating colours is available in the visual configurator and in the Showrooms.

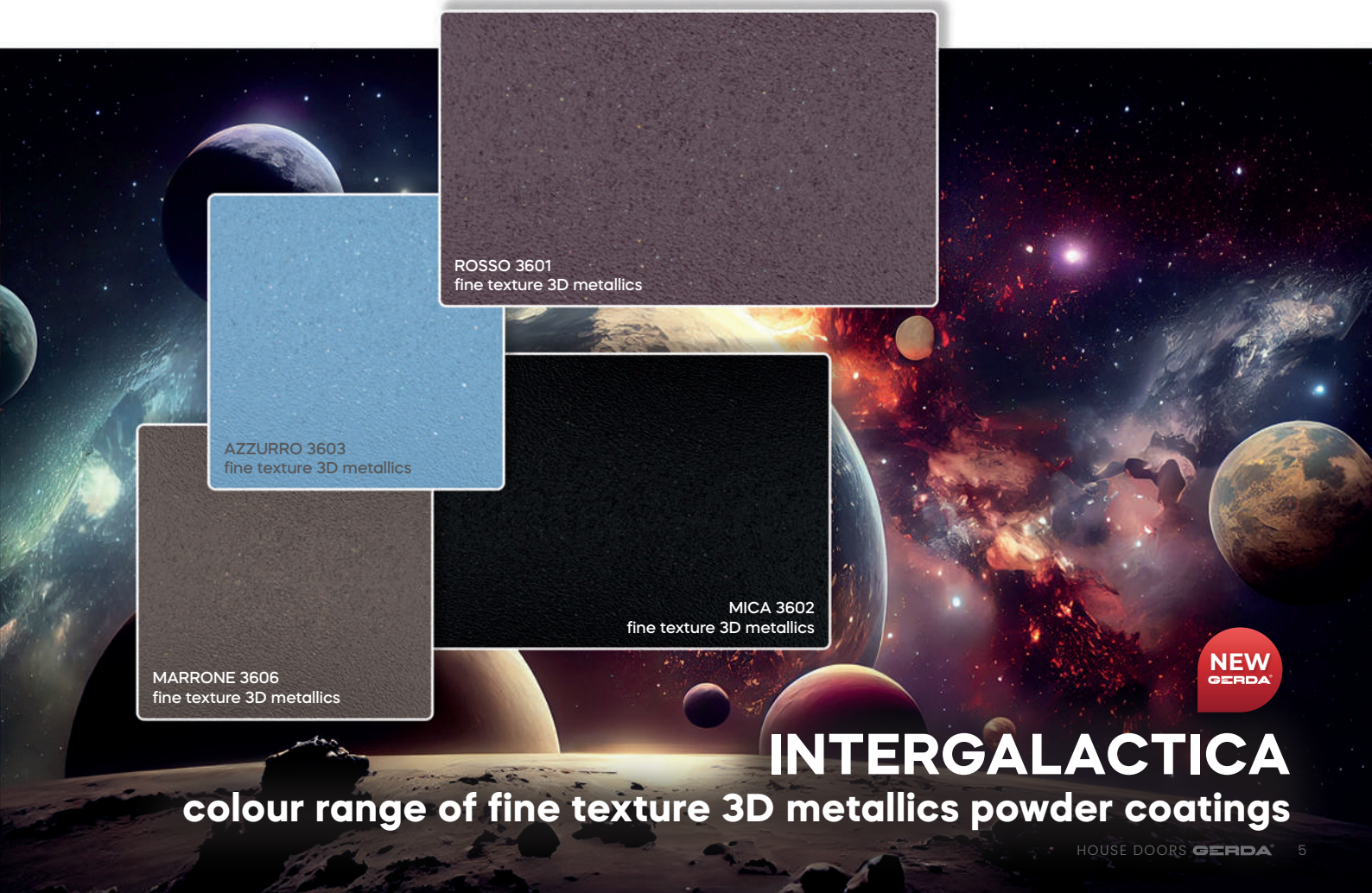

INTERGALACTICA

colour range of fine texture 3D metallics powder coatings



BADEN 1
AIR GLASS

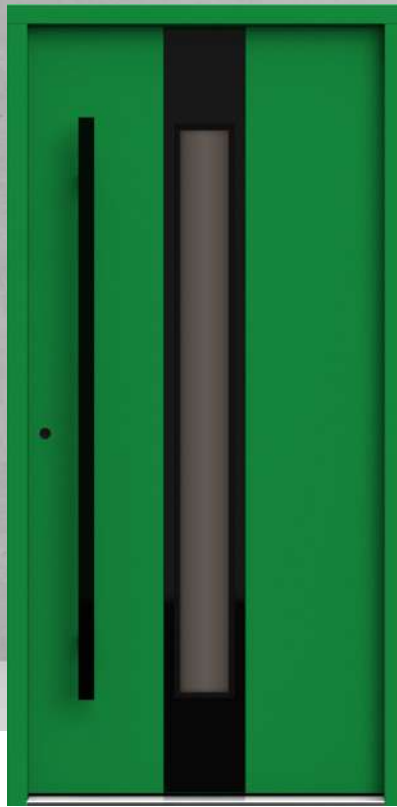

BADEN 2
AIR GLASS



AROSA 1
AIR GLASS



AROSA 2
AIR GLASS



LUCERNA
QUADRO



ONEX
QUADRO



LOCARNO
QUADRO



SION
QUADRO



THUN
QUADRO



INSPIRING COLOURS

available for all door series

Your door in the colour of your dreams!

In addition to material, geometry and structure, it's all about colors and effects that enhance the unique character of the door design.

From now on, we are expanding our color palette for you. A novelty are 4 color lines inspired by the earth, a modern city and space. We evoke the beauty of nature, the metropolitan riot of colours and the mystery of the universe.

The **TERRA** range is a technology based on laminate. There are colors of Mother Earth, among which is wood, the colors of forests, oceans and mountain landscapes.

The **GALA** colour range is the series of powder coatings in a fine-textured version inspired by the energy and dynamics of urban life. Includes bold shades of gray, red and anthracite reflecting the bustling streets, buildings, and ubiquitous neon lights.

GALACTICA is another line of powder-coated fine-textured finishes with a metallic effect. It's a connection between our skies and outer space. Delicate blue colours mix with the setting sun and the view of the stars.

INTERGALACTICA is a powder coated door with a unique 3D effect. This line takes us beyond the boundaries of the Earth's atmosphere. Deep purples, blues, and black hues remind us of the existence of distant nebulae and a mysterious universe.

House doors are exposed to changing atmospheric conditions. Powder coating is an effective corrosion protection for steel surfaces with just one coat of color, reducing the effects of oxygen, water and acids on galvanized steel.



ALUMINIUM DOOR PLATES PRAGA

available for all door series

Made of extruded aluminum, it is extremely robust and highly resistant to damage. The PRAGA aluminium door escutcheon with a width of 53 mm and a spacing of 90 mm and 92 mm with an integrated handle ensures quick installation, reliability and perfectly adapts to GERDA exterior doors. The 8.5 mm thick external and internal door plate is equipped with a handle position tensioner, which translates into its high stabilization.

The PRAGA aluminium escutcheon is available in 3 attractive colour variants, which are obtained in the anodizing process (silver anode, black anode, platinum anode). Exterior surfaces are brushed.

Hardware configurations:

- handle-handle
- handle for handrail
- knob-handle



PLATINUM ANODE



SILVER ANODE



BLACK ANODE

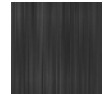

MORTISE LOCK

available for THERMO PRIME and PREMIUM

The new variants of the THERMO PREMIUM 60 and 75 allow you to configure the product with multi-point mortise locks. These are high-quality locks, equipped with a stainless steel list, which are distinguished by failure-free operation and a level of security. Multi-point locks are available in 2 options to choose from: 3-point mechanical lock with two hooks or automatic 3-point lock.

The frames have been equipped with elements enabling full adjustment of latch catches and lock hooks. Exterior doors with mortise locks are operated by a single, burglar-resistant insert. For doors with a hook lock, it is possible to order an additional lock.



3-POINT
2-HOOK
MORTISE LOCK



AUTOMATIC
3-POINT
MORTISE LOCK



RING ESCUTCHEON

available for THERMO PREMIUM

The ring escutcheon is now also available for THERMO PREMIUM doors in a configuration with handrails and a mortise lock. Ring escutcheon is available in black or stainless steel.



INOX



BLACK



NEW DOOR DESIGNS
available for THERMO PRIME and PREMIUM

To enrich the offer and expand the range of available solutions, the THERMO PRIME and THERMO PREMIUM door design lines have been expanded with new constructions:

1. AIR GLASS flushed with the door plane
2. QUADRO inserts in modern stylizations
3. classic ELITE 3D enriched with a new design



DOOR TO SIZE
available for THERMO PRIME and PREMIUM

Creating a door to size option gives you the opportunity to adapt them to individual architectural requirements. The height and width of the door is configured in 10 mm increments and takes the following values:

- THERMO PRIME and THERMO PREMIUM max. height: 2400 mm,
- OPTIMA max. height: 2200 mm,
- .max. width of the door is 1130 mm.

The option of door to size, applies to 15 door models: FLAT, MILANO, HANOVER, JENA.



NEW WINDSTOPPERS
available for all door series

Modern windstoppers, which thanks to a special design and the use of 5 mm long feathers, significantly improve tightness and protection against wind and water. The innovative design of windstoppers allows them to be properly adapted to the appropriate width and emphasizes the high aesthetics of the door.



WINDSTOPPER WITH ALUMINIUM DOOR FRAME



WINDSTOPPER WITH STEEL DOOR FRAME







LONGITUDINAL BOLT SLOTS
available for THERMO PREMIUM and OPTIMA

We introduce elongated bolt slots in GERDA door frames instead of single caps. The change will be made successively and applies to doors of the following series: Thermo Premium and Optima. The new covers significantly improve the adjustment of the installed doors, while not affecting the functional properties.



AIR GLASS / QUADRO

Transparent AIR GLASS gives a unique look to the entire door. The technology of combining the glass with the QUADRO insert is patented. The QUADRO insert, made of stainless steel, is fixed on the plane of the door permanently on metal hooks.

-  AIR GLASS flush with the door plane
-  AIR GLASS between QUADRO inserts
-  insert QUADRO on solid doors
-  QUADRO inserts on glazed doors
-  glass mounted under the door plane





ELITE 3D

Decorative frames in the doors of the ELITE 3D series are attached to the leaf with special hooks.

-  ELITE 3D frames

TEMPO

TEMPO designs are a classic combination of practicality, functionality and simplicity of application shapes. Applications use with glazing are available in black or inox colours. Applications are glued to the door surface or debossed.

-  application
-  debossing
-  debossing with insert
-  application on glazed door

CLASSIC

The CLASSIC series includes a family of doors with decorative deep embossing of the leaf. Among the available designs are glazed and full doors, which gives a lot of freedom of choice. As a special order option, Gerda also introduces deep stamping on the outside of the leaf.

-  deep debossing
-  deep embossing



AIR GLASS BETWEEN QUADRO INSERTS

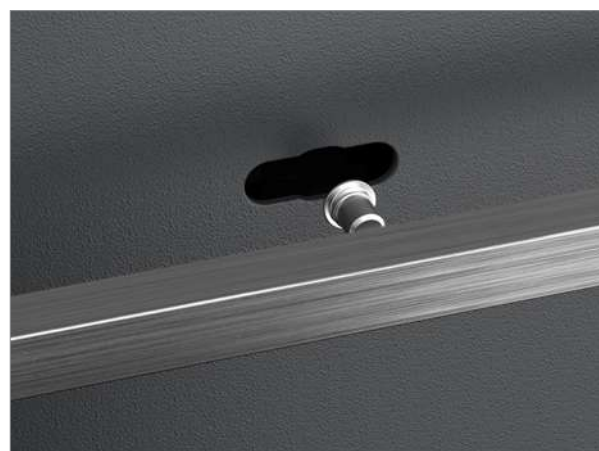

INSERT QUADRO INSTALLATION



DEEP DEBOSSING

THERMAL INSULATION

Heat transfer coefficient (U_p) indicates the amount of thermal energy passing through the door (including the door frame). Based on this coefficient, we are able to determine the heat loss for a given division. Even a slight loss translates to higher heating costs. The coefficient value depends on the type and thickness of the door's material. Gerda HOUSE DOORS comply with the current standards by using modern technologies and steel-wooden or aluminum door frames.

Gerda doors, depending on the components used, may have different insulation coefficient levels:

- insulation doors
- energy-saving doors
- passive doors

The basic doors in our offer, so-called insulation doors, have a coefficient below $1.3 \text{ W/m}^2\text{K}$. The door frame used is a steel PERFOTHERM® frame with thermal perforation, a seal and sill. Energy-saving Optima 60 and Thermo Premium 60 doors have a coefficient starting from $0.9 \text{ W/m}^2\text{K}$ with a warm aluminum ALUTHERM door frame (with thermal chamber filling and a seal) and $1.0 \text{ W/m}^2\text{K}$ with DUOTHERM (warm steel-wooden door frame with thermal perforation and seal).

Passive doors are primarily meant to ensure maximum conservation of energy, while increasing the comfort of living. They allow for energy accumulation in the room, which leads to direct savings. Thermo Premium 75 doors feature a heat transfer coefficient from $0.79 \text{ W/m}^2\text{K}$. The heat transfer coefficient applies to solid doors with a warm aluminum ALUTHERM door frame.

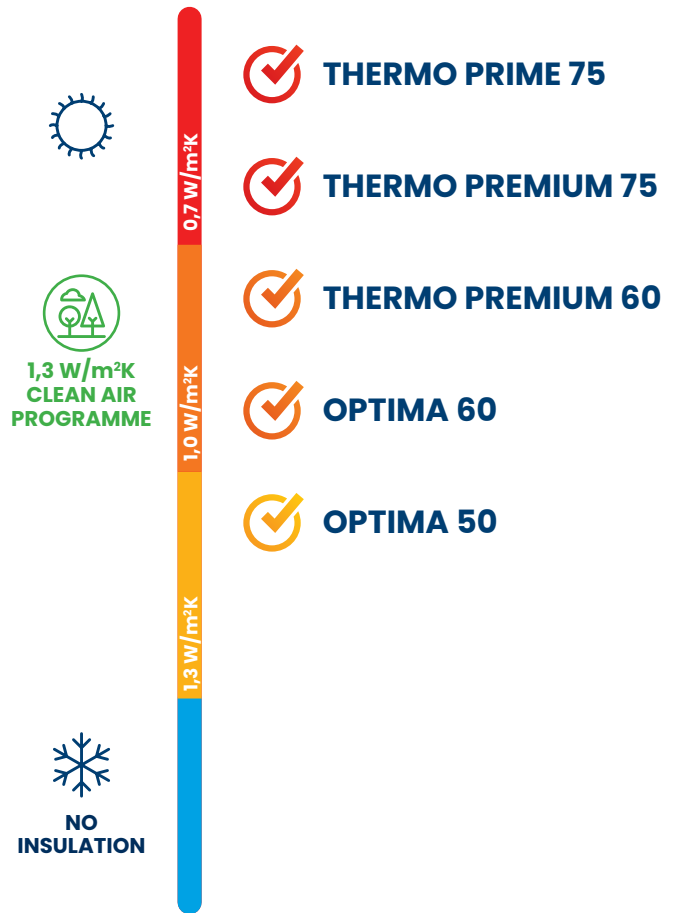

RESISTANCE TO BURGLARY

This parameter is decisive for the so-called anti-burglary doors. Such doors have a solid structure that significantly impedes the possibility to cut out an opening through the door, preventing unauthorized entrance. As a standard, GERDA doors are fitted with two robust locks with a multi-point bolting system. Their key element are

anti-prizing bolts that prevent forcing the door leaf or lifting it off the hinges. GERDA doors are tested for resistance to burglary and hold an anti-burglary protection class from RC2 to RC3. The higher the class of doors installed, the greater the safety of people and property in the house.

RC2 CLASS

- PLIERS
- WEDGE
- HAMMER

RC3 CLASS





- STEEL PRY BAR
- WEDGE
- HAMMER
- MECHANICAL DRILL

RC4 CLASS

- HEAVY HAMMER
- AXE
- CHISEL
- BIT
- HAMMER DRILL



 **THERMO PRIME 75**

UD	THERMAL INSULATION U _f VALUES FOR INWARD-OPENING REFERENCE DOORS	ALUTHERM 75 DOOR FRAME SOLID DOOR 0,79 W/m²K GLAZED DOOR 0,9 W/m²K
RC	RESISTANCE CLASS	RC2
	LEAF THICKNESS	75 mm
	DOOR SIZES	80 · 90N · 90E · 100E*
	DESIGN LINES	AIR GLASS · QUADRO · ELITE 3D · TEMPO
	LEAF STRUCTURE	WOODEN FRAME + PUR FOAM
	DOOR TO SIZE	DOOR HEIGHT UP TO 2400 mm DOOR WIDTH UP TO 1130 mm

**ALUTHERM 75 DOOR FRAME
SOLID DOOR / GLAZED DOOR**

$U_d = 0,79 / 0,9 \text{ W/m}^2\text{K}$

**STEEL DOOR FRAME
SOLID DOOR / GLAZED DOOR**

-

RC2



Adjustable hook hitches



Adjustable pawl hitch

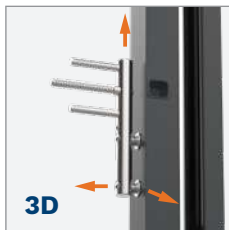

Hinges adjustable in three planes with caps matching fitting's colour



Door leaf with thermal division



ALUTHERM 75 door frame



Mortise lock:
5 point hooked or
3 point automatic

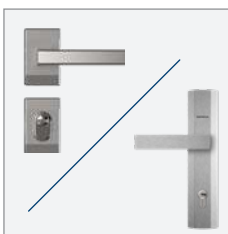

You can choose NEW long door plate PRAGA or split door plate BERGEN



Ring escutcheon for door with a handrail*



Composite connector of threshold with windstopper – for more info see page 9

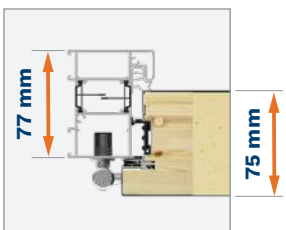

ALUTHERM 75 door frame

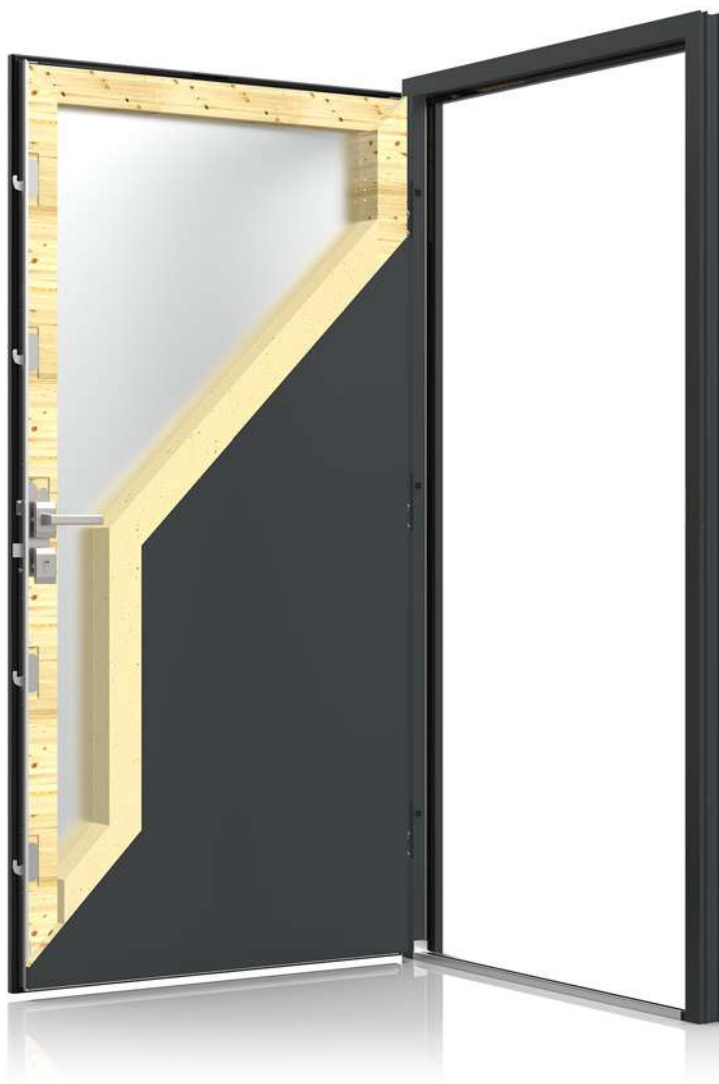

4 sides rebated



Class 5 lock cylinder, AB system: A – installer's keys + B – final user keys



Lower upstand brush seal PRIME



Fixed anti-prizing bolts



Warm aluminium with subthreshold extension, h=35 mm



GERDA RESIST ULTRA insulation duo tapes*







tedee PRO + bridge set*

* EXTRA CHARGE



 **THERMO PREMIUM 75**

UD	THERMAL INSULATION U _g VALUES FOR INWARD-OPENING REFERENCE DOORS	ALUTHERM 75 DOOR FRAME* SOLID DOOR 0,79 W/m²K GLAZED DOOR 1,1 W/m²K	DUOTHERM 75 DOOR FRAME SOLID DOOR 0,87 W/m²K GLAZED DOOR 1,3 W/m²K
RC	RESISTANCE CLASS	RC2 / RC3**	
	LEAF THICKNESS	75 mm	
	DOOR SIZES	80 · 90N · 90E · 100E*	
	DESIGN LINES	AIR GLASS · QUADRO · ELITE 3D · TEMPO	
	LEAF STRUCTURE	WOODEN FRAME + EXPANDED GRAPHITE POLYSTYRENE	
	DOOR TO SIZE	DOOR HEIGHT UP TO 2400 mm DOOR WIDTH UP TO 1130 mm	

**ALUTHERM 75* DOOR FRAME
SOLID DOOR / GLAZED DOOR**

**DUOTHERM 75 DOOR FRAME
SOLID DOOR / GLAZED DOOR**

$U_D = 0,79 / 1,1 \text{ W/m}^2\text{K}$

$U_D = 0,87 / 1,3 \text{ W/m}^2\text{K}$

RC2 / RC3**



You can choose NEW long door plate PRAGA or split door plate BERGEN



Class 5 lock cylinder, AB system: A – installer's keys + B – final user keys

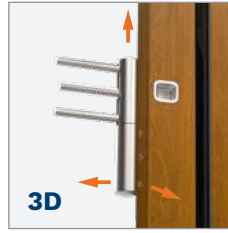

Hinges adjustable in three planes with caps matching fitting's colour



Adjustable pawl hitch

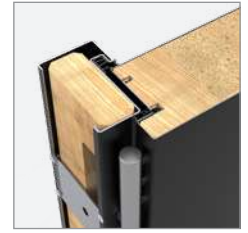

DUOTHERM 75 door frame



Auxiliary 3-bolt lock



Main 3-bolt lock

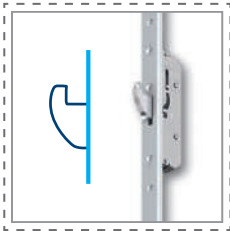

Mortise lock 3-point 2-hook*

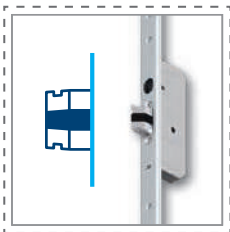

Mortise lock 3-point automatic*



Door leaf with thermal division



Lower upstand brush seal



Fixed anti-prizing bolts



Warm aluminium with subthreshold extension, h=35 mm



GERDA RESIST ULTRA insulation duo tapes*

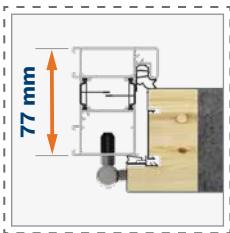

ALUTHERM 75* door frame

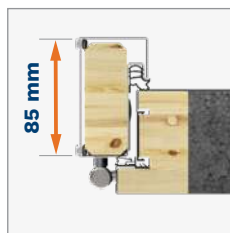

DUOTHERM 75 door frame



Composite connector of threshold with windstopper – for more info see page 9



4 sides rebated







tedee PRO + bridge set*

* EXTRA CHARGE

** ONLY SOLID DOORS, EXTRA CHARGE



 **THERMO PREMIUM 60**

UD	THERMAL INSULATION U _f VALUES FOR INWARD-OPENING REFERENCE DOORS	ALUTHERM 60 DOOR FRAME* SOLID DOOR 0,86 W/m²K GLAZED DOOR 1,2 W/m²K	DUOTHERM 60 DOOR FRAME SOLID DOOR 0,94 W/m²K GLAZED DOOR 1,3 W/m²K
RC	RESISTANCE CLASS	RC2 / RC3**	
	LEAF THICKNESS	60 mm	
	DOOR SIZES	80 · 90N · 90E · 100E*	
	DESIGN LINES	AIR GLASS · QUADRO · ELITE 3D · TEMPO	
	LEAF STRUCTURE	WOODEN FRAME + EXPANDED GRAPHITE POLYSTYRENE	
	DOOR TO SIZE	DOOR HEIGHT UP TO 2400 mm DOOR WIDTH UP TO 1130 mm	

ALUTHERM 60 DOOR FRAME*
SOLID DOOR / GLAZED DOOR

DUOTHERM 60 DOOR FRAME
SOLID DOOR / GLAZED DOOR

$U_D = 0,86 / 1,2 \text{ W/m}^2\text{K}$

$U_D = 0,94 / 1,3 \text{ W/m}^2\text{K}$

RC2 / RC3**



You can choose NEW long door plate PRAGA or BERGEN



Class 5 lock cylinder, AB system: A – installer's keys + B – final user keys

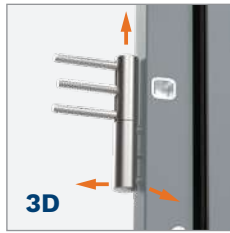

Hinges adjustable in three planes with caps matching fitting's colour



Adjustable pawl hitch

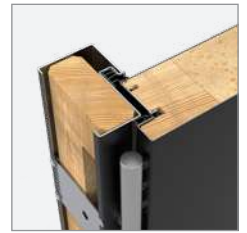

DUOTHERM 60 door frame



Auxiliary 3-bolt lock



Main 3-bolt lock

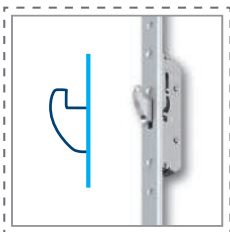

Mortise lock 3-point 2-hook*

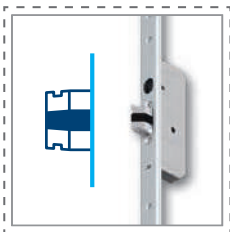

Mortise lock 3-point automatic*

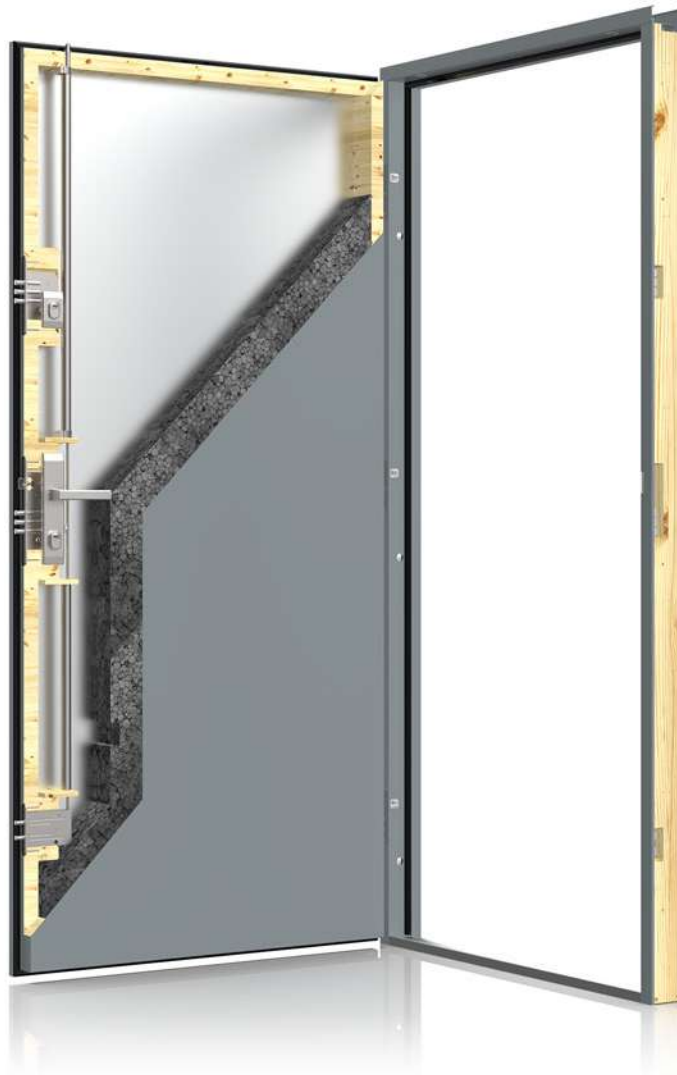

Lower upstand brush seal



Fixed anti-prizing bolts



Warm aluminium with subthreshold extension, h=35 mm



GERDA RESIST ULTRA insulation duo tapes*

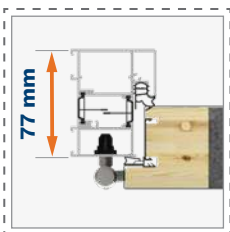

ALUTHERM 60* door frame

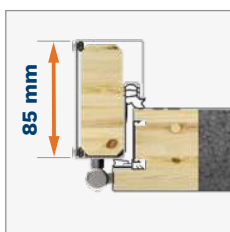

DUOTHERM 60 door frame



Composite connector of threshold with windstopper – for more info see page 9



4 sides rebated



tedee PRO + bridge set*

* EXTRA CHARGE

** ONLY SOLID DOORS, EXTRA CHARGE

 THERMO PRIME

 THERMO PREMIUM

AIR GLASS



AGK BADEN 1 p. 26



AGL BADEN 2 p. 26



AGM AROSA 1 p. 26



AGN AROSA 2 p. 26



AGB LINZ 1 p. 28



AGC LINZ 2 p. 28



AGDB LINZ 3 B p. 28

QUADRO



KP1 LUCERNA p. 34



KP2 LOZANNA p. 34



KP3 THUN p. 34



KP4 SION p. 34



KW9 LOCARNO p. 36



KWA ONEX p. 36



KWA PASAWA 1 p. 38



KWH BAMBERG 3 p. 42



KWI BAMBERG 4 p. 42



KWJ ULM 1 p. 44



KWK ULM 2 p. 44



KWL TREWIR 1 p. 46



KWM TREWIR 2 p. 46



KWN TREWIR 3 p. 46



KPZ KRONACH 4 p. 52



KPJ REGEN 1 p. 54



KPK REGEN 2 p. 54



KPL REGEN 3 p. 54



KPS REGEN 4 p. 54



KPM REGEN 5 p. 54



KPRB REGEN 6 B p. 54

ELITE 3D



ELF DAVOS p. 60



ELA BRIG p. 60



ELB OLTEN p. 60



ELC VISP p. 60



ELD TRIN p. 60



ELE BERNO p. 60



NS1 MILANO 8 p. 62

TEMPO

 THERMO PRIME

 THERMO PREMIUM

AIR GLASS



AGE GRAZ 1 p. 30



AGF GRAZ 2 p. 30



AGGB GRAZ 3 B p. 30



AGA SALZBURG p. 32



AGA SALZBURG p. 32



AGH VILLACH p. 32



AGHB VILLACH B p. 32

QUADRO



KWB PASAWA 2 p. 38



KWC PASAWA 3 p. 38



KWD PASAWA 4 p. 38



KWE JENA 3 p. 40



KW4 JENA 4 p. 40



KWF BAMBERG 1 p. 42



KWG BAMBERG 2 p. 42



KWP TREWIR 4 p. 46



KWS DORFEN p. 48



KWT KASSEL 1 p. 50



KWX KASSEL 2 p. 50



KPN KRONACH 1 p. 52



KPPB KRONACH 2 B p. 52



KPT KRONACH 3 p. 52



KPE DREZNO 1 p. 56



KPF DREZNO 2 p. 56



KPH DREZNO 4 p. 56



KPAB ERFURT 1 B p. 58



KPA ERFURT 1 p. 58



KPB ERFURT 2 p. 58



KPC ERFURT 3 p. 58

TEMPO



NS2 MILANO 9 p. 62



NS3 MILANO 10 p. 62



NS4 MILANO 11 p. 62



NS5B HANOVER 5 B p. 64



NS6 HANOVER 6 p. 64







NS7 INNSBRUCK p. 64



W00 FLAT p. 66



 **OPTIMA 60**

UD	THERMAL INSULATION U _f VALUES FOR INWARD-OPENING REFERENCE DOORS	ALUTHERM 60 DOOR FRAME* SOLID DOOR 1,0 W/m²K GLAZED DOOR 1,3 W/m²K	PERFOTHERM 60 DOOR FRAME SOLID DOOR 1,1 W/m²K GLAZED DOOR 1,3 W/m²K
RC	RESISTANCE CLASS	RC2 / RC3**	
	LEAF THICKNESS	60 mm	
	DOOR SIZES	80N · 80 · 90N · 90E · 100E*	
	DESIGN LINES	TEMPO · CLASSIC	
	LEAF STRUCTURE	WOODEN FRAME + EXPANDED GRAPHITE POLYSTYRENE	
	CUSTOM HEIGHT	UP TO 2200 mm	

**ALUTHERM 60 DOOR FRAME*
SOLID DOOR / GLAZED DOOR**

**PERFOTHERM 60 DOOR FRAME
SOLID DOOR / GLAZED DOOR**

$U_D = 1,0 / 1,3 \text{ W/m}^2\text{K}$

$U_D = 1,1 / 1,3 \text{ W/m}^2\text{K}$

RC2 / RC3**



You can choose NEW long door plate PRAGA or BERGEN



Class 5 lock cylinder, AB system: A – installer's keys + B – final user keys

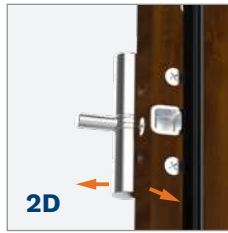

Hinges adjustable in two planes with caps matching fitting's colour



Adjustable pawl hitch



PERFOTHERM 60 door frame



Vertical bolt*



Auxiliary 3-bolt lock



Main 3-bolt lock



Auxiliary 2-bolt lock*



Fixed anti-prizing bolts

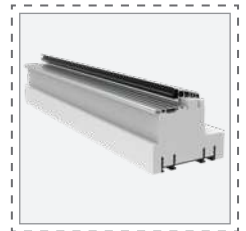

Warm aluminium with subthreshold extension, h=35 mm
PERFOTHERM 60 option*
ALUTHERM 60 standard



GERDA RESIST ULTRA insulation duo tapes*

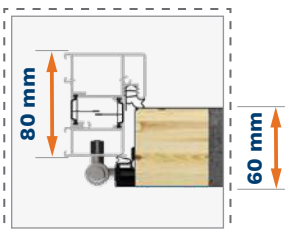

ALUTHERM 60* door frame

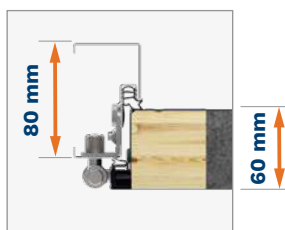

PERFOTHERM 60 door frame

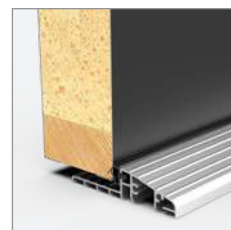

3 sides rebated







tedee PRO + bridge set*

* EXTRA CHARGE

** ONLY SOLID DOORS, EXTRA CHARGE



 **OPTIMA 50**

UD	THERMAL INSULATION U _D VALUES FOR INWARD-OPENING REFERENCE DOORS	PERFOTHERM 50 DOOR FRAME* SOLID DOOR 1,2 W/m²K
RC	RESISTANCE CLASS	RC2
 mm	LEAF THICKNESS	50 mm
	DOOR SIZES	80N · 80 · 90N · 90E · 100E*
	DESIGN LINES	TEMPO · CLASSIC
	LEAF STRUCTURE	WOODEN BLOCKS + WOODEN FRAME + EXPANDED GRAPHITE POLYSTYRENE
 mm	CUSTOM HEIGHT	UP TO 2200 mm

**ALUMINIUM DOOR FRAME
SOLID DOOR / GLAZED DOOR**

**PERFOTHERM 50 DOOR FRAME*
SOLID DOOR**



$U_D = 1,2 \text{ W/m}^2\text{K}$

RC2



You can choose NEW long door plate PRAGA or BERGEN



Class 5 lock cylinder, AB system: A – installer's keys + B – final user keys

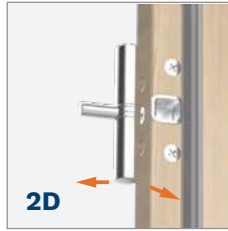

Hinges adjustable in two planes with caps matching fitting's colour



Adjustable pawl hitch



FB steel door frame



Auxiliary 3-bolt lock



Main 3-bolt lock



Fixed anti-prizing bolts



FN steel door frame



Warm aluminium with subthreshold extension, h=35 mm PERFOTHERM 50 option*



GERDA RESIST ULTRA insulation duo tapes*

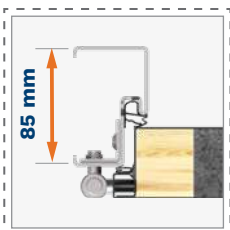

PERFOTHERM 50* steel door frame

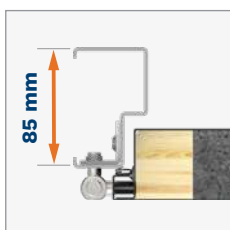

FB steel door frame

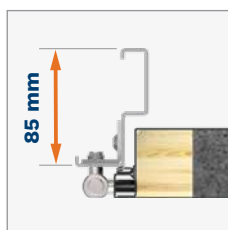

FN steel door frame

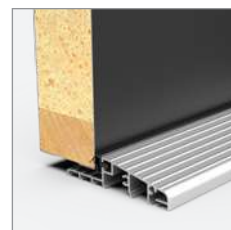

3 sides rebated



tedee PRO + bridge set*

* EXTRA CHARGE

 **OPTIMA 60**

 **OPTIMA 50**

TEMPO



NS1 MILANO 8 p. 68



NS2 MILANO 9 p. 68



NS3 MILANO 10 p. 68



NS4 MILANO 11 p. 68



NS9 MILANO 12 p. 68



NS9B MILANO 12 B p. 68



NS5 HANOVER 5 p. 64



NT1 TURYN 1 p. 70



NT2 TURYN 2 p. 70



SOJ BERGAMO 2 p. 72



SJ9 NICEA 9 p. 72



SBE BERLIN 4 p. 72



ST4 UPPSALA 1 p. 74



ST4A UPPSALA 1A p. 74



WBA ASPEN 1 p. 78



TN7 ASPEN 2 p. 78



TN7B ASPEN 2B p. 78



SR3 TROMSO 1 p. 80



SR4 TROMSO 1 p. 80



SR5 TROMSO 2 p. 80



SR5 TROMSO 2 p. 80



NS5B HANOVER 5 B p. 64



NS6 HANOVER 6 p. 64



NS7 INNSBRUCK 1 p. 64



W00 PŁASKIE 1 p. 66



W00 PŁASKIE 2 p. 66



SNU MILANO 4 p. 68



SNUA MILANO 4 A p. 68



SNUB MILANO 4 B p. 68



TML TOKIO 1 p. 76



TMLA TOKIO 1A p. 76



TMM TOKIO 2 p. 76



TMMA TOKIO 2A p. 76



ST8 RYGA 1 p. 78



ST9 LUND 1 p. 78

 **OPTIMA 60**

 **OPTIMA 50**

CLASSIC



W76 MODENA p. 82



W77 MODENA 2 p. 82



W78 MODENA 3 p. 82



WDR RAVENA p. 82



WDR RAVENA p. 82



WJ1 NICEA 5 p. 84



W23 OLYMPIA p. 84



W13 LONDYN p. 88



W5L LONDYN 1 p. 88



W54 BARCELONA p. 90



W53 BARCELONA 1 p. 90



G76 GENEWA 1 p. 90



G75 GENEWA 2 p. 90



D75 GENEWA 3 p. 90



W91 WERONA p. 86



W94 WERONA 1 p. 86



W93 WERONA 3 p. 86



W6A WERONA 4 p. 86



WQA WERONA 5 p. 86



W24 LIZBONA p. 88



W9N WENECJA p. 88

OPTIMA 60 DUO



SOJ BERGAMO 2 + NMBA p. 92



NS5 HANOVER 5 + DW9 p. 92



ST8 RYGA + P00 p. 92



TMMA TOKIO 2 A + P00 p. 92



NS9 MILANO 12 + DW8 p. 92



SNUA MILANO 4 A + PD5A p. 92



NT2B TURYN 2 B + DT8B p. 92



ST4A UPPSALA 1 A + NMAA p. 92



NS6 HANOVER 6 + DW8 p. 92



AGK BADEN 1



AGL BADEN 2

DOOR SIZE	80	90N	90E	100E*
DOOR HEIGHT (DUOTHERM / ALUTHERM)	2076 / 2087 mm			

MODEL	THERMO PREMIUM 60	THERMO PREMIUM 75	THERMO PRIME 75
AGK BADEN 1	✓	✓	✓
AGL BADEN 2	✓	✓	✓
AGM AROSA 1	✓	✓	✓
AGN AROSA 2	✓	✓	✓

RC2 STANDARD EQUIPMENT**

• GLAZED DOOR LEAF	• WARM THRESHOLD WITH SUBTHRESHOLD EXTENSION, h=35 mm
• 4 SIDES REBATED	• FITTINGS SET
• THERMO PREMIUM – DUOTHERM DOOR FRAME	• T. PRIME – LONG ESCUTCHEONS: PRAGA OR SPLIT: BERGEN
• THERMO PRIME – ALUTHERM 75 DOOR FRAME	• THERMO PREMIUM – LONG ESCUTCHEONS: PRAGA OR BERGEN
• HINGES ADJUSTABLE IN THREE PLANES WITH CAPS MATCHING FITTING'S COLOUR	• THERMO PREMIUM – CLASS 5 LOCK CYLINDER, KEYED ALIKE SYSTEM, BOLT LOCK
• FLUSH AIR GLASS	• THERMO PRIME – CLASS 5 LOCK CYLINDER, 5 POINT HOOK MORTISE LOCK OR 3 POINT AUTOMATIC MORTISE LOCK
• SINGLE-SIDED DESIGN	

EXTRA CHARGES

POWDER COATING, GALA COLOUR RANGE	✓
POWDER COATING, GALACTICA / GALA OPEN COLOUR RANGE	✓
POWDER COATING, INTERGALACTICA COLOUR RANGE	✓
TWO-COLOUR DOOR, GALA COLOUR RANGE	✓
THERMO PREMIUM – ALUTHERM DOOR FRAME	1800 mm
THERMO PREMIUM – MORTISE LOCK 3-POINT 2-HOOK / AUTOMATIC	AMSTERDAM / MONTREAL HANDRAIL 1700 mm ELECTRIC STRIKE RECOMMENDED 1500 mm
THERMO PREMIUM – AUXILIARY LOCK FOR MORTISE LOCK 2-HOOK	1000 mm
TWO-COLOUR DOOR, TERRA PALETTE	AMSTERDAM / MONTREAL HANDRAIL WITH PUSHBUTTON, 1800 mm WITH DOOR LEAF ADJUSTMENT AND ELECTRIC STRIKE 1700 mm
CLASS 6 LOCK CYLINDERS, KEYED ALIKE SYSTEM	1500 mm
THERMO PREMIUM – UPPER ESCUTCHEON PROTECTION	1000 mm
KNOB-HANDLE	AMSTERDAM HANDRAIL WITH WIRELESS PUSHBUTTON 1700 mm ELECTRIC STRIKE NECESSARY 1500 mm
REED SWITCH	ROSTOCK HANDRAIL 2000 mm
SIZE 100E	tedee PRO SET
INTEGRATED CLOSER	
ELECTRIC STRIKE WITH DAY / NIGHT FEATURE	THERMO PREMIUM – RING ESCUTCHEON FOR DOOR WITH HANDRAIL AND MORTISE LOCK no extra charge

FIXED GLAZED SIDE PANELS: PAGES 94–95, FULL EQUIPMENT LIST: PAGES 98–105

GLASS

AIR GLASS

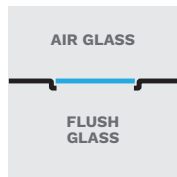

DOOR COLOURS

ALPINE WALNUT

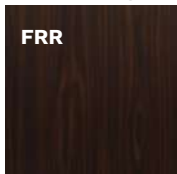

MAHOGANY

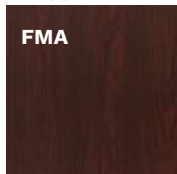

BRAZILIAN WALNUT

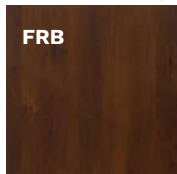

LIGHT WALNUT

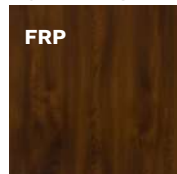

GOLDEN OAK

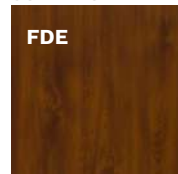

WINCHESTER

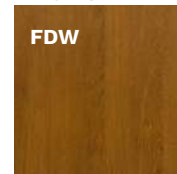

TURNER OAK





AGM AROSA 1



AGM AROSA 1
INTERNAL SIDE



AGK BADEN 1
INTERNAL SIDE



AGN AROSA 2



AGN AROSA 2
INTERNAL SIDE



AGL BADEN 2
INTERNAL SIDE

standard FITTINGS

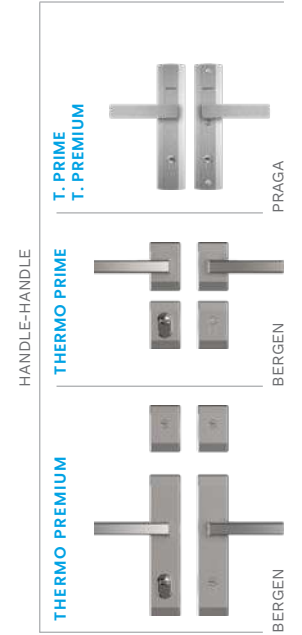

extra charge FITTINGS

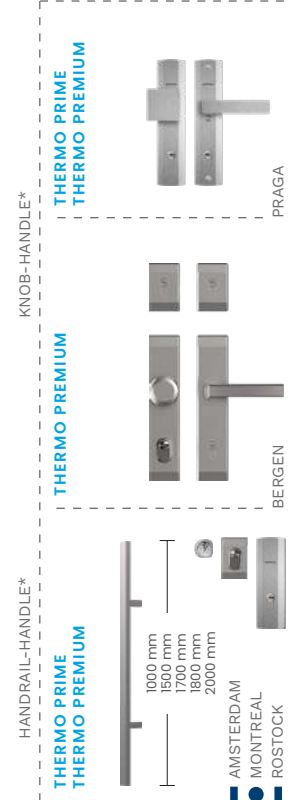

FITTINGS COLOURS

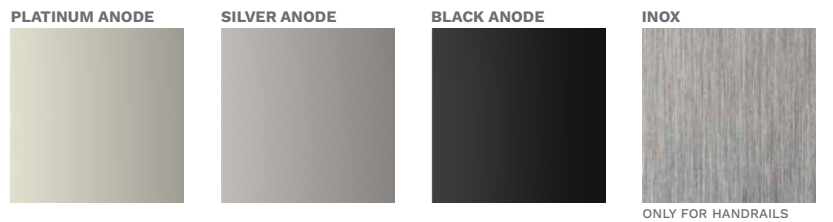

DOOR COLOURS



* EXTRA CHARGE

** FOR GLAZED DOORS RC2N



AGB LINZ 1



AGC LINZ 2

DOOR SIZE	80	90N	90E	100E*
DOOR HEIGHT (DUOTHERM / ALUTHERM)	2076 mm / 2087 mm			
MODEL	THERMO PREMIUM 60	THERMO PREMIUM 75	THERMO PRIME 75	
AGB LINZ 1 / AGBB LINZ 1 B	✓	✓	✓	
AGC LINZ 2 / AGCB LINZ 2 B	✓	✓	✓	
AGD LINZ 3 / AGDB LINZ 3 B	✓	✓	✓	

RC2 STANDARD EQUIPMENT**

- GLAZED DOOR LEAF
- 4 SIDES REBATED
- THERMO PREMIUM – DUOTHERM DOOR FRAME
- THERMO PRIME – ALUTHERM 75 DOOR FRAME
- HINGES ADJUSTABLE IN THREE PLANES WITH CAPS MATCHING FITTING'S COLOUR
- AIR GLASS BETWEEN QUADRO INSERTS
- SINGLE-SIDED DESIGN
- WARM THRESHOLD WITH SUBTHRESHOLD EXTENSION, h=35 mm
- FITTINGS SET
- T. PRIME – LONG ESCUTCHEONS: PRAGA OR SPLIT: BERGEN
- THERMO PREMIUM – LONG ESCUTCHEONS: PRAGA OR BERGEN
- THERMO PREMIUM – CLASS 5 LOCK CYLINDER, KEYED ALIKE SYSTEM, BOLT LOCK
- THERMO PRIME – CLASS 5 LOCK CYLINDER, 5 POINT HOOK MORTISE LOCK OR 3 POINT AUTOMATIC MORTISE LOCK

EXTRA CHARGES

POWDER COATING, GALA COLOUR RANGE	✓
POWDER COATING, GALACTICA / GALA OPEN COLOUR RANGE	✓
POWDER COATING, INTERGALACTICA COLOUR RANGE	✓
TWO-COLOUR DOOR, GALA COLOUR RANGE	✓
THERMO PREMIUM – ALUTHERM DOOR FRAME	1800 mm
THERMO PREMIUM – MORTISE LOCK 3-POINT 2-HOOK / AUTOMATIC	AMSTERDAM / MONTREAL HANDRAIL 1700 mm ELECTRIC STRIKE RECOMMENDED 1500 mm
THERMO PREMIUM – AUXILIARY LOCK FOR MORTISE LOCK 2-HOOK	1000 mm
TWO-COLOUR DOOR, TERRA PALETTE	AMSTERDAM / MONTREAL HANDRAIL WITH PUSHBUTTON, WITH DOOR LEAF ADJUSTMENT AND ELECTRIC STRIKE 1800 mm 1700 mm
CLASS 6 LOCK CYLINDERS, KEYED ALIKE SYSTEM	1500 mm 1000 mm
THERMO PREMIUM – UPPER ESCUTCHEON PROTECTION	AMSTERDAM HANDRAIL WITH WIRELESS PUSHBUTTON 1700 mm ELECTRIC STRIKE NECESSARY 1500 mm
KNOB-HANDLE	
REED SWITCH	ROSTOCK HANDRAIL 2000 mm
SIZE 100E	
INTEGRATED CLOSER	tedee PRO SET
ELECTRIC STRIKE WITH DAY / NIGHT FEATURE	THERMO PREMIUM – RING ESCUTCHEON FOR DOOR WITH HANDRAIL AND MORTISE LOCK no extra charge

FIXED GLAZED SIDE PANELS: PAGES 94–95, FULL EQUIPMENT LIST: PAGES 98–105

GLASS

AIR GLASS



DOOR COLOURS

ALPINE WALNUT

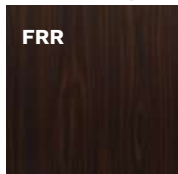

MAHOGANY

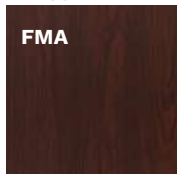

BRAZILIAN WALNUT

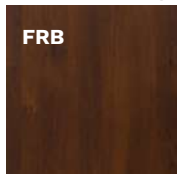

LIGHT WALNUT

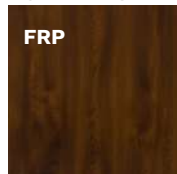

GOLDEN OAK

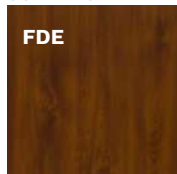

WINCHESTER

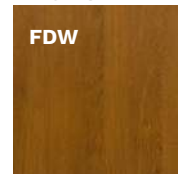

TURNER OAK





AGD LINZ 3



AGD LINZ 3
INTERNAL SIDE



AGC LINZ 2



AGDB LINZ 3 B



AGDB LINZ 3 B
INTERNAL SIDE



AGC LINZ 2

standard FITTINGS

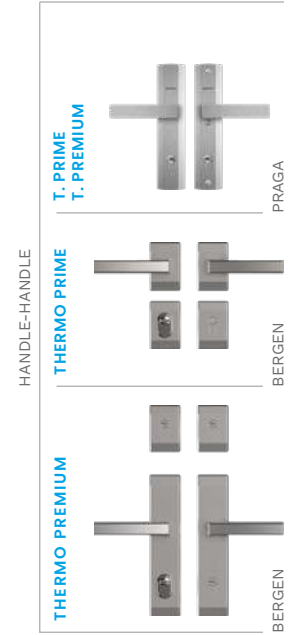

extra charge FITTINGS

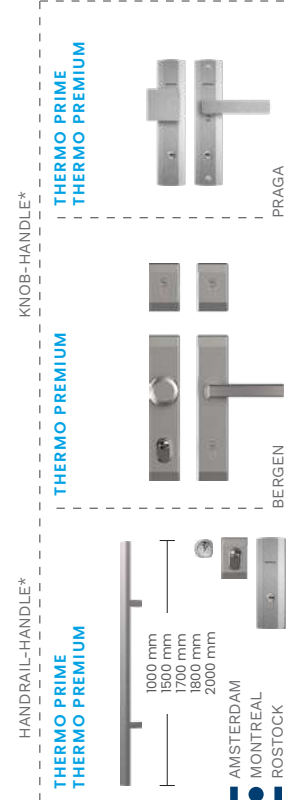

QUADRO INSERT COLOURS

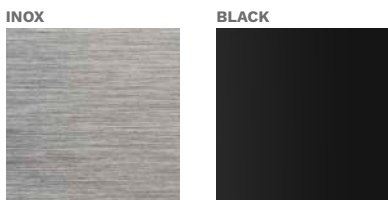

FITTINGS COLOURS

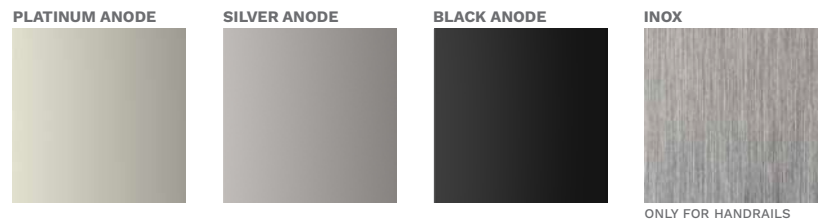

DOOR COLOURS



* EXTRA CHARGE

** FOR GLAZED DOORS RC2N



AGE GRAZ 1



AGF GRAZ 2

DOOR SIZE	80	90N	90E	100E*
DOOR HEIGHT (DUOTHERM / ALUTHERM)	2076 mm / 2087 mm			

MODEL	THERMO PREMIUM 60	THERMO PREMIUM 75	THERMO PRIME 75
AGE GRAZ 1 / AGE B GRAZ 1 B	✓	✓	✓
AGF GRAZ 2 / AGFB GRAZ 2 B	✓	✓	✓
AGG GRAZ 3 / AGGB GRAZ 3 B	✓	✓	✓

RC2 STANDARD EQUIPMENT**

• GLAZED DOOR LEAF	• WARM THRESHOLD WITH SUBTHRESHOLD EXTENSION, h=35 mm
• 4 SIDES REBATED	• FITTINGS SET
• THERMO PREMIUM – DUOTHERM DOOR FRAME	• T. PRIME – LONG ESCUTCHEONS: PRAGA OR SPLIT: BERGEN
• THERMO PRIME – ALUTHERM 75 DOOR FRAME	• THERMO PREMIUM – LONG ESCUTCHEONS: PRAGA OR BERGEN
• HINGES ADJUSTABLE IN THREE PLANES WITH CAPS MATCHING FITTING'S COLOUR	• THERMO PREMIUM – CLASS 5 LOCK CYLINDER, KEYED ALIKE SYSTEM, BOLT LOCK
• AIR GLASS BETWEEN QUADRO INSERTS	• THERMO PRIME – CLASS 5 LOCK CYLINDER, 5 POINT HOOK MORTISE LOCK OR 3 POINT AUTOMATIC MORTISE LOCK
• SINGLE-SIDED DESIGN	

EXTRA CHARGES

POWDER COATING, GALA COLOUR RANGE	✓
POWDER COATING, GALACTICA / GALA OPEN COLOUR RANGE	✓
POWDER COATING, INTERGALACTICA COLOUR RANGE	✓
TWO-COLOUR DOOR, GALA COLOUR RANGE	✓
THERMO PREMIUM – ALUTHERM DOOR FRAME	1800 mm
THERMO PREMIUM – MORTISE LOCK 3-POINT 2-HOOK / AUTOMATIC	AMSTERDAM / MONTREAL HANDRAIL 1700 mm ELECTRIC STRIKE RECOMMENDED 1500 mm
THERMO PREMIUM – AUXILIARY LOCK FOR MORTISE LOCK 2-HOOK	1000 mm
TWO-COLOUR DOOR, TERRA PALETTE	AMSTERDAM / MONTREAL 1800 mm HANDRAIL WITH PUSHBUTTON, WITH DOOR LEAF ADJUSTMENT AND ELECTRIC STRIKE 1700 mm
CLASS 6 LOCK CYLINDERS, KEYED ALIKE SYSTEM	1500 mm 1000 mm
THERMO PREMIUM – UPPER ESCUTCHEON PROTECTION	AMSTERDAM HANDRAIL 1700 mm WITH WIRELESS PUSHBUTTON
KNOB-HANDLE	ELECTRIC STRIKE NECESSARY 1500 mm
REED SWITCH	ROSTOCK HANDRAIL 2000 mm
SIZE 100E	tedee PRO SET
INTEGRATED CLOSER	
ELECTRIC STRIKE WITH DAY / NIGHT FEATURE	THERMO PREMIUM – RING ESCUTCHEON FOR DOOR WITH HANDRAIL AND MORTISE LOCK no extra charge

FIXED GLAZED SIDE PANELS: PAGES 94–95, FULL EQUIPMENT LIST: PAGES 98–105

GLASS

AIR GLASS

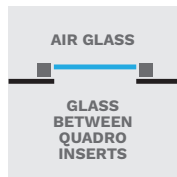

DOOR COLOURS

ALPINE WALNUT

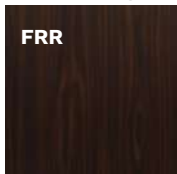

MAHOGANY

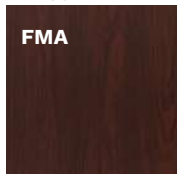

BRAZILIAN WALNUT

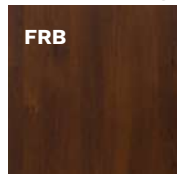

LIGHT WALNUT

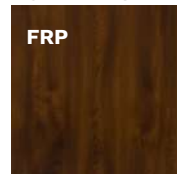

GOLDEN OAK

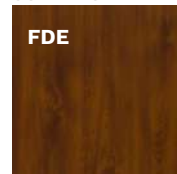

WINCHESTER

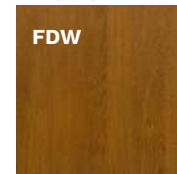

TURNER OAK





AGGB GRAZ 3 B



**AGGB GRAZ 3 B
INTERNAL SIDE**



**AGF GRAZ 2
INTERNAL SIDE**



AGF GRAZ 2



**AGF GRAZ 2
INTERNAL SIDE**



AGF GRAZ 2

standard FITTINGS

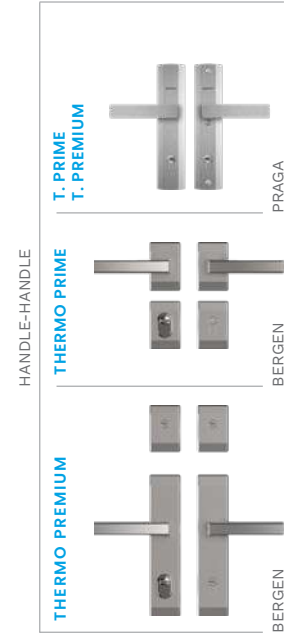

extra charge FITTINGS

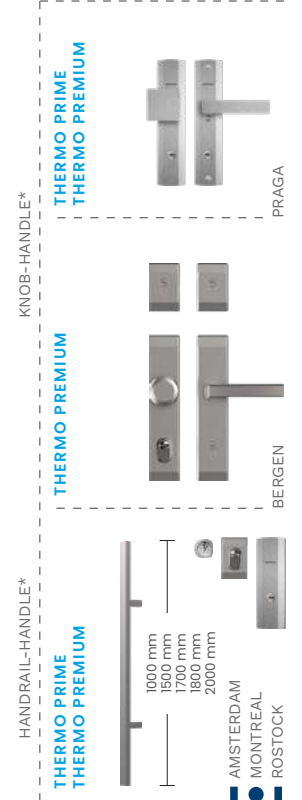

QUADRO INSERT COLOURS

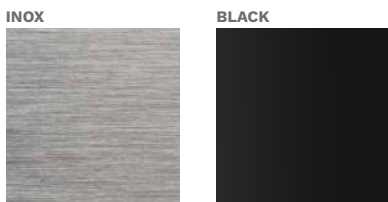

FITTINGS COLOURS

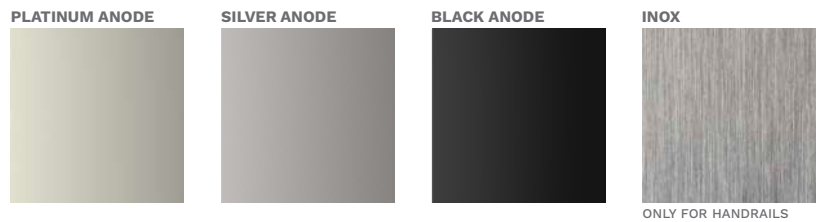

DOOR COLOURS



* EXTRA CHARGE

** FOR GLAZED DOORS RC2N



AGA SALZBURG



AGHB VILLACH B

DOOR SIZE SALZBURG	80	90N	90E	100E*
DOOR SIZE VILLACH	-	-	90E	100E*
DOOR HEIGHT SALZBURG (DUOTHERM / ALUTHERM)	2076 mm / 2087 mm			
DOOR HEIGHT VILLACH (DUOTHERM / ALUTHERM)	2076 mm / 2087-2400 mm			

MODEL	THERMO PREMIUM 60	THERMO PREMIUM 75	THERMO PRIME 75
AGA SALZBURG / AGAB SALZBURG B	✓	✓	✓
AGH VILLACH / AGHB VILLACH B	✓	✓	✓

RC2 STANDARD EQUIPMENT**

• GLAZED DOOR LEAF	• WARM THRESHOLD WITH SUBTHRESHOLD EXTENSION, h=35 mm
• 4 SIDES REBATED	• FITTINGS SET
• THERMO PREMIUM – DUOTHERM DOOR FRAME	• T. PRIME – LONG ESCUTCHEONS: PRAGA OR SPLIT; BERGEN
• THERMO PRIME – ALUTHERM 75 DOOR FRAME	• THERMO PREMIUM – LONG ESCUTCHEONS: PRAGA OR BERGEN
• HINGES ADJUSTABLE IN THREE PLANES WITH CAPS MATCHING FITTING'S COLOUR	• THERMO PREMIUM – CLASS 5 LOCK CYLINDER, KEYED ALIKE SYSTEM, BOLT LOCK
• AIR GLASS BETWEEN QUADRO INSERTS	• THERMO PRIME – CLASS 5 LOCK CYLINDER, 5 POINT HOOK MORTISE LOCK OR 3 POINT AUTOMATIC MORTISE LOCK
• SINGLE-SIDED DESIGN	

EXTRA CHARGES

POWDER COATING, GALA COLOUR RANGE	✓
N POWDER COATING, GALACTICA / GALA OPEN COLOUR RANGE	✓
POWDER COATING, INTERGALACTICA COLOUR RANGE	✓
TWO-COLOUR DOOR, GALA COLOUR RANGE	✓
AGH VILLACH / AGHB VILLACH B	2150 mm, 2200 mm
CUSTOM HEIGHT, INCREMENTS EVERY 50 mm,	2250 mm, 2300 mm
AVAILABLE COLOURS: FRP, FDE, FDW, FDT, FKG, FKF, FSB,	2350 mm, 2400 mm
ONLY WITH ALUTHERM DOOR FRAME	
THERMO PREMIUM – ALUTHERM DOOR FRAME	1800 mm
THERMO PREMIUM – MORTISE LOCK 3-POINT 2-HOOK / AUTOMATIC	AMSTERDAM / MONTREAL HANDRAIL 1700 mm ELECTRIC STRIKE RECOMMENDED 1500 mm
THERMO PREMIUM – AUXILIARY LOCK FOR MORTISE LOCK 2-HOOK	1000 mm
TWO-COLOUR DOOR, TERRA PALETTE	AMSTERDAM / MONTREAL HANDRAIL WITH PUSHBUTTON, WITH DOOR LEAF ADJUSTMENT AND ELECTRIC STRIKE 1800 mm 1700 mm 1500 mm 1000 mm
CLASS 6 LOCK CYLINDERS, KEYED ALIKE SYSTEM	
THERMO PREMIUM – UPPER ESCUTCHEON PROTECTION	AMSTERDAM HANDRAIL 1700 mm WITH WIRELESS PUSHBUTTON ELECTRIC STRIKE NECESSARY 1500 mm
KNOB-HANDLE	
REED SWITCH	ROSTOCK HANDRAIL 2000 mm
SIZE 100E	
INTEGRATED CLOSER	tedee PRO SET
ELECTRIC STRIKE WITH DAY / NIGHT FEATURE	THERMO PREMIUM – RING ESCUTCHEON FOR DOOR WITH HANDRAIL AND MORTISE LOCK no extra charge

FIXED GLAZED SIDE PANELS: PAGES 94–95, FULL EQUIPMENT LIST: PAGES 98–105

GLASS

AIR GLASS



DOOR COLOURS

ALPINE WALNUT

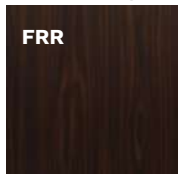

MAHOGANY

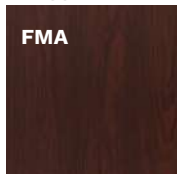

BRAZILIAN WALNUT

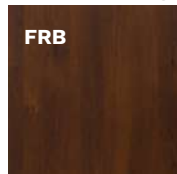

LIGHT WALNUT

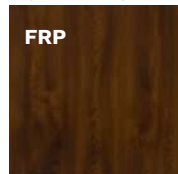

GOLDEN OAK

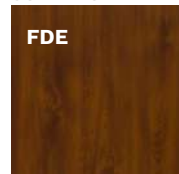

WINCHESTER

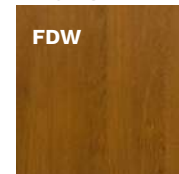

TURNER OAK





AGH VILLACH



**AGH VILLACH
INTERNAL SIDE**



AGA SALZBURG



**AGA SALZBURG
INTERNAL SIDE**



**AGA SALZBURG
INTERNAL SIDE**

standard FITTINGS

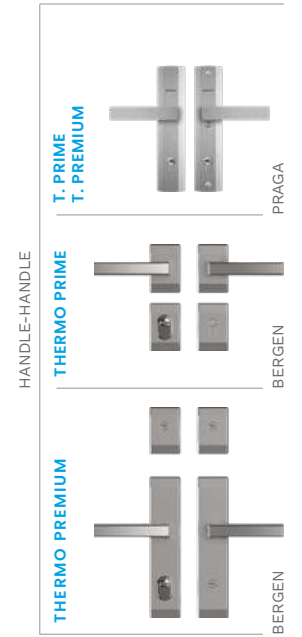

extra charge FITTINGS

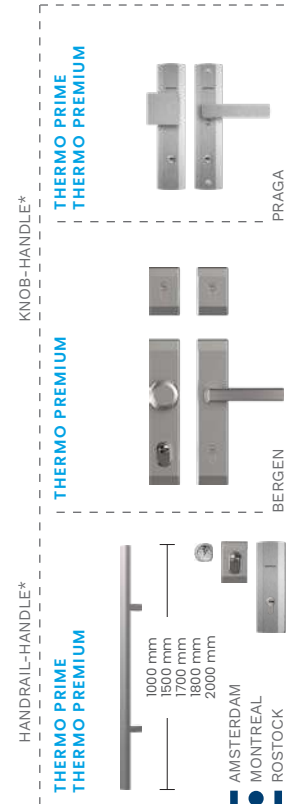

QUADRO INSERT COLOURS

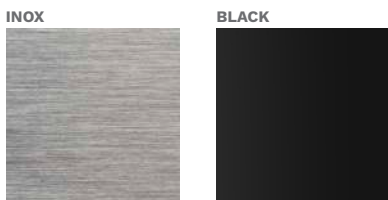

FITTINGS COLOURS

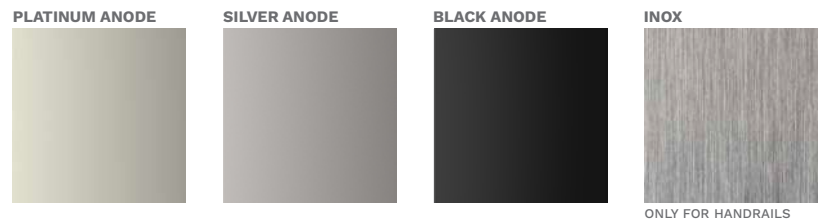

DOOR COLOURS



* EXTRA CHARGE

** FOR GLAZED DOORS RC2N



KP1 LUCERNA



KP2B LOZANNA B

DOOR SIZE LOZANNA, THUN, SION	80	90N	90E	100E*
DOOR SIZE LUCERNA	-	90N	90E	100E*
DOOR HEIGHT (DUOTHERM / ALUTHERM)	2076 mm / 2087 mm			

MODEL	THERMO PREMIUM 60	THERMO PREMIUM 75	THERMO PRIME 75
KP1 LUCERNA / KP1B LUCERNA B	✓	✓	✓
KP2 LOZANNA / KP2B LOZANNA B	✓	✓	✓
KP3 THUN / KP3B THUN B	✓	✓	✓
KP4 SION / KP4B SION B	✓	✓	✓

RC2 STANDARD EQUIPMENT**

- SOLID DOOR LEAF
- 4 SIDES REBATED
- THERMO PREMIUM – DUOTHERM DOOR FRAME
- THERMO PRIME – ALUTHERM 75 DOOR FRAME
- HINGES ADJUSTABLE IN THREE PLANES WITH CAPS MATCHING FITTING'S COLOUR
- QUADRO INSERTS
- SINGLE-SIDED DESIGN
- WARM THRESHOLD WITH SUBTHRESHOLD EXTENSION, h=35 mm
- FITTINGS SET
- T. PRIME – LONG ESCUTCHEONS: PRAGA OR SPLIT: BERGEN
- THERMO PREMIUM – LONG ESCUTCHEONS: PRAGA OR BERGEN
- THERMO PREMIUM – CLASS 5 LOCK CYLINDER, KEYED ALIKE SYSTEM, BOLT LOCK
- THERMO PRIME – CLASS 5 LOCK CYLINDER, 5 POINT HOOK MORTISE LOCK OR 3 POINT AUTOMATIC MORTISE LOCK

EXTRA CHARGES

POWDER COATING, GALA COLOUR RANGE	✓
POWDER COATING, GALACTICA / GALA OPEN COLOUR RANGE	✓
POWDER COATING, INTERGALACTICA COLOUR RANGE	✓
TWO-COLOUR DOOR, GALA COLOUR RANGE	✓
THERMO PREMIUM – ALUTHERM DOOR FRAME	1800 mm
THERMO PREMIUM – MORTISE LOCK 3-POINT 2-HOOK / AUTOMATIC	AMSTERDAM / MONTREAL HANDRAIL 1700 mm ELECTRIC STRIKE RECOMMENDED 1500 mm
THERMO PREMIUM – AUXILIARY LOCK FOR MORTISE LOCK 2-HOOK	1000 mm
TWO-COLOUR DOOR, TERRA PALETTE	AMSTERDAM / MONTREAL HANDRAIL WITH PUSHBUTTON, WITH DOOR LEAF ADJUSTMENT AND ELECTRIC STRIKE 1800 mm 1700 mm
RC3 PACK	1500 mm
CLASS 6 LOCK CYLINDERS, KEYED ALIKE SYSTEM	1000 mm
THERMO PREMIUM – UPPER ESCUTCHEON PROTECTION	AMSTERDAM HANDRAIL WITH WIRELESS PUSHBUTTON 1700 mm ELECTRIC STRIKE NECESSARY 1500 mm
KNOB-HANDLE	
REED SWITCH	ROSTOCK HANDRAIL 2000 mm
SIZE 100E	
INSERT – OPPOSITE SIDE	DOOR SHORTENING (10, 20, 30, 40 mm)
INTEGRATED CLOSER	tedee PRO SET
ELECTRIC STRIKE WITH DAY / NIGHT FEATURE	THERMO PREMIUM – RING ESCUTCHEON FOR DOOR WITH HANDRAIL AND MORTISE LOCK no extra charge

FIXED GLAZED SIDE PANELS: PAGES 94–95, FULL EQUIPMENT LIST: PAGES 98–105

DOOR COLOURS

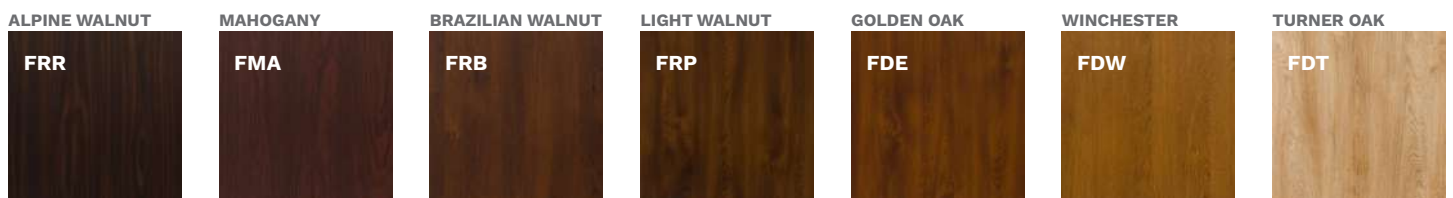



KPIB LUCERNA B



KP4 SION



KP4 SION



KP3B THUN B



KP3 THUN

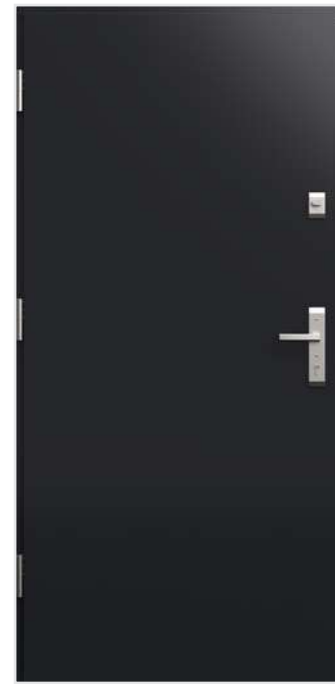

**KPS THUN
INTERNAL SIDE**

standard FITTINGS

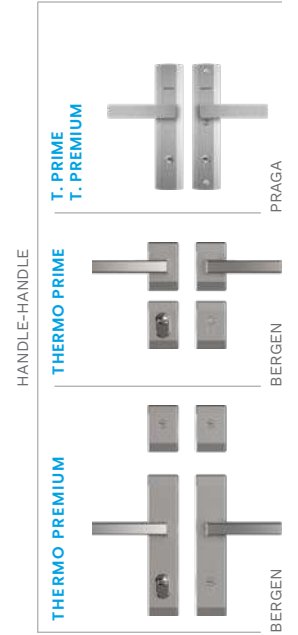

extra charge FITTINGS

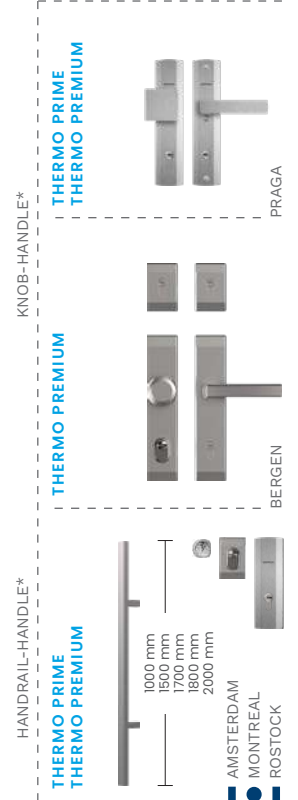

QUADRO INSERT COLOURS



DOOR COLOURS



* EXTRA CHARGE

** FOR GLAZED DOORS RC2N



KW9 LOCARNO



KVAB ONEX B

DOOR SIZE	80	90N	90E	100E*
DOOR HEIGHT (DUOTHERM / ALUTHERM)	2076 mm / 2087 mm			

MODEL	THERMO PREMIUM 60	THERMO PREMIUM 75	THERMO PRIME 75
KW9 LOCARNO / KW9B LOCARNO B	✓	✓	✓
KVA ONEX / KVAB ONEX B	✓	✓	✓

RC2 STANDARD EQUIPMENT**

• GLAZED DOOR LEAF	• WARM THRESHOLD WITH SUBTHRESHOLD EXTENSION, h=35 mm
• 4 SIDES REBATED	• FITTINGS SET
• THERMO PREMIUM – DUOTHERM DOOR FRAME	• T. PRIME – LONG ESCUTCHEONS: PRAGA OR SPLIT; BERGEN
• THERMO PRIME – ALUTHERM 75 DOOR FRAME	• THERMO PREMIUM – LONG ESCUTCHEONS: PRAGA OR BERGEN
• HINGES ADJUSTABLE IN THREE PLANES WITH CAPS MATCHING FITTING'S COLOUR	• THERMO PREMIUM – CLASS 5 LOCK CYLINDER, KEYED ALIKE SYSTEM, BOLT LOCK
• QUADRO INSERTS	• THERMO PRIME – CLASS 5 LOCK CYLINDER, 5 POINT HOOK MORTISE LOCK OR 3 POINT AUTOMATIC MORTISE LOCK
• GLASS UNDERNEATH THE DOOR PLANE	
• SINGLE-SIDED DESIGN	

EXTRA CHARGES

POWDER COATING, GALA COLOUR RANGE	✓
POWDER COATING, GALACTICA / GALA OPEN COLOUR RANGE	✓
POWDER COATING, INTERGALACTICA COLOUR RANGE	✓
TWO-COLOUR DOOR, GALA COLOUR RANGE	✓
THERMO PREMIUM – ALUTHERM DOOR FRAME	1800 mm
THERMO PREMIUM – MORTISE LOCK 3-POINT 2-HOOK / AUTOMATIC	AMSTERDAM / MONTREAL HANDRAIL 1700 mm ELECTRIC STRIKE RECOMMENDED 1500 mm 1000 mm
THERMO PREMIUM – AUXILIARY LOCK FOR MORTISE LOCK 2-HOOK	AMSTERDAM / MONTREAL 1800 mm HANDRAIL WITH PUSHBUTTON, WITH DOOR LEAF ADJUSTMENT AND ELECTRIC STRIKE 1700 mm 1500 mm 1000 mm
TWO-COLOUR DOOR, TERRA PALETTE	
CLASS 6 LOCK CYLINDERS, KEYED ALIKE SYSTEM	AMSTERDAM HANDRAIL 1700 mm WITH WIRELESS PUSHBUTTON 1500 mm ELECTRIC STRIKE NECESSARY
THERMO PREMIUM – UPPER ESCUTCHEON PROTECTION	
KNOB-HANDLE	ROSTOCK HANDRAIL 2000 mm
REED SWITCH	DOOR SHORTENING (10, 20, 30, 40 mm)
SIZE 100E	tedee PRO SET
INTEGRATED CLOSER	
ELECTRIC STRIKE WITH DAY / NIGHT FEATURE	THERMO PREMIUM – RING ESCUTCHEON FOR DOOR WITH HANDRAIL AND MORTISE LOCK no extra charge

FIXED GLAZED SIDE PANELS: PAGES 94–95, FULL EQUIPMENT LIST: PAGES 98–105

GLASS

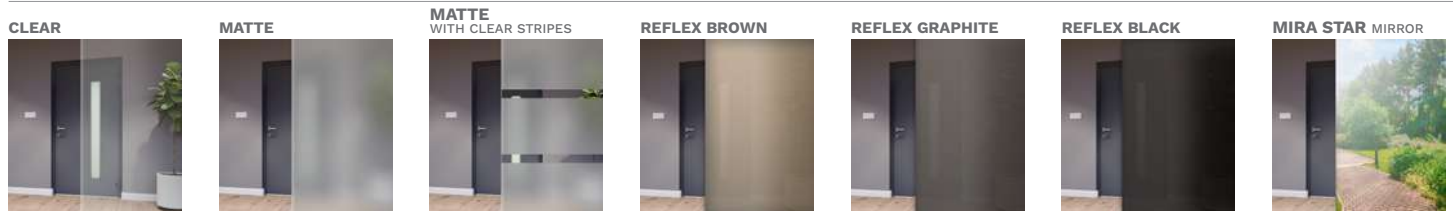

DOOR COLOURS

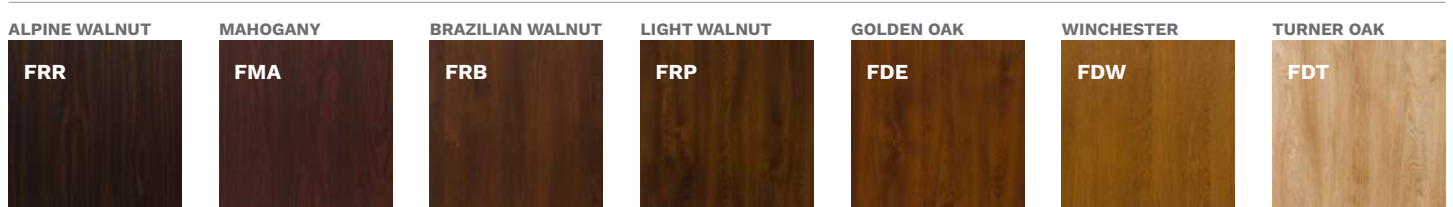



KW9 LOCARNO



KW9B LOCARNO B



KW9 LOCARNO



KVA ONEX



KVA ONEX
INTERNAL SIDE



KVAB ONEX B

standard FITTINGS

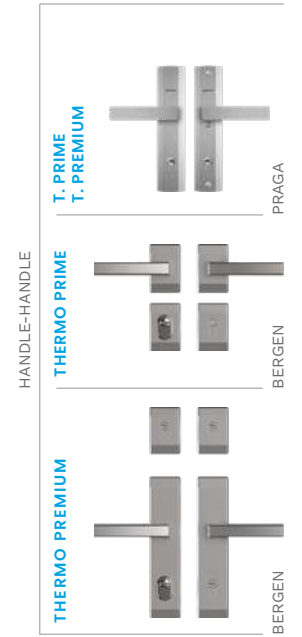

extra charge FITTINGS

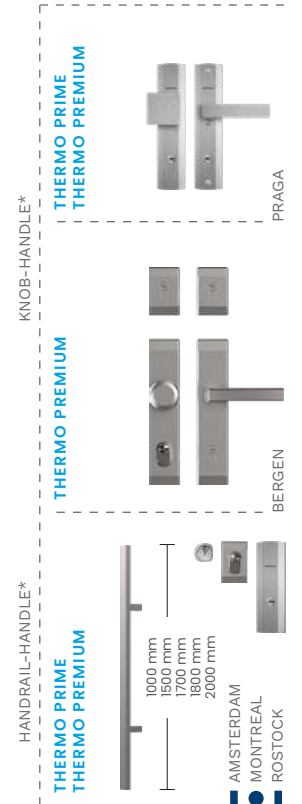

QUADRO INSERT COLOURS



DOOR COLOURS



* EXTRA CHARGE

** FOR GLAZED DOORS RC2N



KWA PASAWA 1



KWB PASAWA 2

DOOR SIZE	80	90N	90E	100E*
DOOR HEIGHT (DUOTHERM / ALUTHERM)	2076 mm / 2087 mm			

MODEL	THERMO PREMIUM 60	THERMO PREMIUM 75	THERMO PRIME 75
KWA PASAWA 1 / KWAB PASAWA 1 B	✓	✓	✓
KWB PASAWA 2 / KWBB PASAWA 2 B	✓	✓	✓
KWC PASAWA 3 / KWCB PASAWA 3 B	✓	✓	✓
KWD PASAWA 4 / KWDB PASAWA 4 B	✓	✓	✓

RC2 STANDARD EQUIPMENT**

• GLAZED DOOR LEAF	• WARM THRESHOLD WITH SUBTHRESHOLD EXTENSION, h=35 mm
• 4 SIDES REBATED	• FITTINGS SET
• THERMO PREMIUM – DUOTHERM DOOR FRAME	• T. PRIME – LONG ESCUTCHEONS: PRAGA OR SPLIT: BERGEN
• THERMO PRIME – ALUTHERM 75 DOOR FRAME	• THERMO PREMIUM – LONG ESCUTCHEONS: PRAGA OR BERGEN
• HINGES ADJUSTABLE IN THREE PLANES WITH CAPS MATCHING FITTING'S COLOUR	• THERMO PREMIUM – CLASS 5 LOCK CYLINDER, KEYED ALIKE SYSTEM, BOLT LOCK
• QUADRO INSERTS	• THERMO PRIME – CLASS 5 LOCK CYLINDER, 5 POINT HOOK MORTISE LOCK OR 3 POINT AUTOMATIC MORTISE LOCK
• GLASS UNDERNEATH THE DOOR PLANE	
• SINGLE-SIDED DESIGN	

EXTRA CHARGES

POWDER COATING, GALA COLOUR RANGE	✓
POWDER COATING, GALACTICA / GALA OPEN COLOUR RANGE	✓
POWDER COATING, INTERGALACTICA COLOUR RANGE	✓
TWO-COLOUR DOOR, GALA COLOUR RANGE	✓
AGH VILLACH / AGHB VILLACH B	2150 mm, 2200 mm
CUSTOM HEIGHT, INCREMENTS EVERY 50 mm,	2250 mm, 2300 mm
AVAILABLE COLOURS: FRP, FDE, FDW, FDT, FKG, FKF, FSB, ONLY WITH ALUTHERM DOOR FRAME	2350 mm, 2400 mm
THERMO PREMIUM – ALUTHERM DOOR FRAME	1800 mm
THERMO PREMIUM – MORTISE LOCK 3-POINT 2-HOOK / AUTOMATIC	AMSTERDAM / MONTREAL HANDRAIL 1700 mm ELECTRIC STRIKE RECOMMENDED 1500 mm 1000 mm
THERMO PREMIUM – AUXILIARY LOCK FOR MORTISE LOCK 2-HOOK	AMSTERDAM / MONTREAL 1800 mm HANDRAIL WITH PUSHBUTTON, WITH DOOR LEAF ADJUSTMENT AND ELECTRIC STRIKE 1700 mm 1500 mm
TWO-COLOUR DOOR, TERRA PALETTE	1000 mm
CLASS 6 LOCK CYLINDERS, KEYED ALIKE SYSTEM	AMSTERDAM HANDRAIL 1700 mm WITH WIRELESS PUSHBUTTON 1500 mm ELECTRIC STRIKE NECESSARY
THERMO PREMIUM – UPPER ESCUTCHEON PROTECTION	2000 mm
KNOB-HANDLE	ROSTOCK HANDRAIL
REED SWITCH	DOOR SHORTENING KWA, KWB, KWC (10, 20, 30, 40 mm), KWD (10, 20, 30, 40, 60, 80, 100 mm)
SIZE 100E	tedee PRO SET
INTEGRATED CLOSER	
ELECTRIC STRIKE WITH DAY / NIGHT FEATURE	THERMO PREMIUM – RING ESCUTCHEON FOR DOOR WITH HANDRAIL AND MORTISE LOCK no extra charge

FIXED GLAZED SIDE PANELS: PAGES 94–95, FULL EQUIPMENT LIST: PAGES 98–105

GLASS

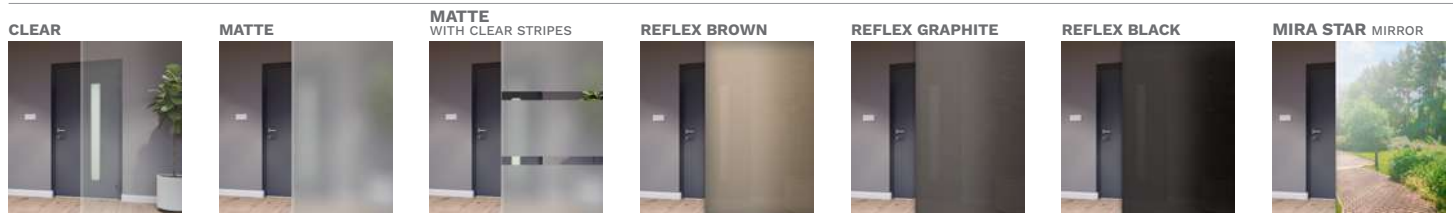

DOOR COLOURS

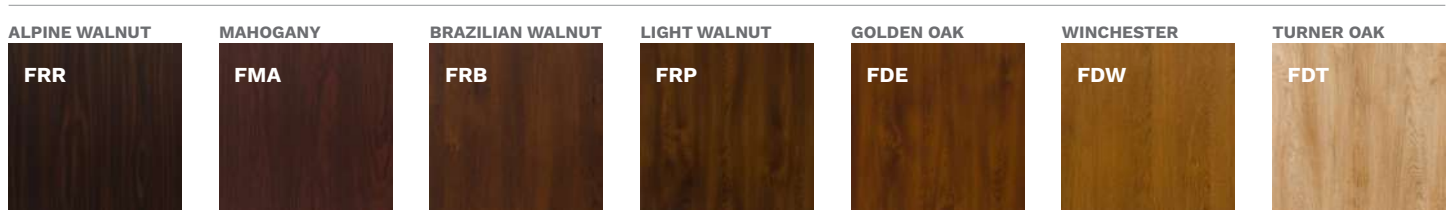



KWCB PASAWA 3 B



KWD PASAWA 4



KWD PASAWA 4
INTERNAL SIDE



KWA PASAWA 1



KWA PASAWA 1
INTERNAL SIDE



KWC PASAWA 3

standard FITTINGS

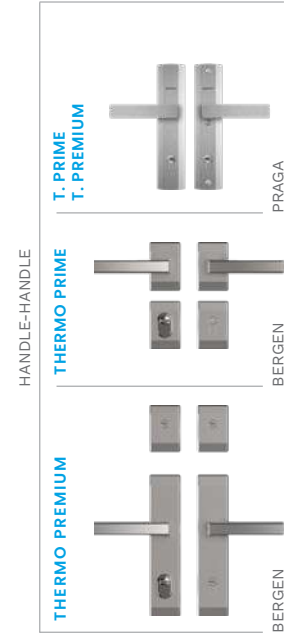

extra charge FITTINGS

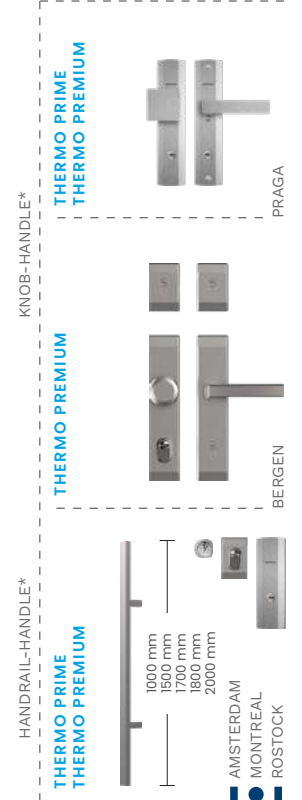

QUADRO INSERT COLOURS



DOOR COLOURS



* EXTRA CHARGE

** FOR GLAZED DOORS RC2N



KW3 JENA 3



KW4 JENA 4

DOOR SIZE	80	90N	90E	100E*
DOOR HEIGHT (DUOTHERM / ALUTHERM)	2076 mm / 2087 mm			

MODEL	THERMO PREMIUM 60	THERMO PREMIUM 75	THERMO PRIME 75
KW3 JENA 3	✓	✓	✓
KW4 JENA 4	✓	✓	✓

RC2 STANDARD EQUIPMENT**

• GLAZED DOOR LEAF	• WARM THRESHOLD WITH SUBTHRESHOLD EXTENSION, h=35 mm
• 4 SIDES REBATED	• FITTINGS SET
• THERMO PREMIUM – DUOTHERM DOOR FRAME	• T. PRIME – LONG ESCUTCHEONS: PRAGA OR SPLIT: BERGEN
• THERMO PRIME – ALUTHERM 75 DOOR FRAME	• THERMO PREMIUM – LONG ESCUTCHEONS: PRAGA OR BERGEN
• HINGES ADJUSTABLE IN THREE PLANES WITH CAPS MATCHING FITTING'S COLOUR	• THERMO PREMIUM – CLASS 5 LOCK CYLINDER, KEYED ALIKE SYSTEM, BOLT LOCK
• QUADRO INSERTS	• THERMO PRIME – CLASS 5 LOCK CYLINDER, 5 POINT HOOK MORTISE LOCK OR 3 POINT AUTOMATIC MORTISE LOCK
• GLASS UNDERNEATH THE DOOR PLANE	
• SINGLE-SIDED DESIGN	

EXTRA CHARGES

POWDER COATING, GALA COLOUR RANGE		✓
POWDER COATING, GALACTICA / GALA OPEN COLOUR RANGE		✓
POWDER COATING, INTERGALACTICA COLOUR RANGE		✓
TWO-COLOUR DOOR, GALA COLOUR RANGE		✓
CUSTOM HEIGHT, INCREMENTS EVERY 50 mm, AVAILABLE COLOURS: FRP, FDE, FDW, FDT, FKG, FKF, FSB, ONLY WITH ALUTHERM DOOR FRAME	2150 mm, 2200 mm 2250 mm, 2300 mm 2350 mm, 2400 mm	
THERMO PREMIUM – ALUTHERM DOOR FRAME	1800 mm	
THERMO PREMIUM – MORTISE LOCK 3-POINT 2-HOOK / AUTOMATIC	AMSTERDAM / MONTREAL HANDRAIL ELECTRIC STRIKE RECOMMENDED	1700 mm 1500 mm 1000 mm
THERMO PREMIUM – AUXILIARY LOCK FOR MORTISE LOCK 2-HOOK	AMSTERDAM / MONTREAL HANDRAIL WITH PUSHBUTTON, WITH DOOR LEAF ADJUSTMENT AND ELECTRIC STRIKE	1800 mm 1700 mm 1500 mm 1000 mm
TWO-COLOUR DOOR, TERRA PALETTE	AMSTERDAM HANDRAIL WITH WIRELESS PUSHBUTTON ELECTRIC STRIKE NECESSARY	1700 mm 1500 mm
CLASS 6 LOCK CYLINDERS, KEYED ALIKE SYSTEM	ROSTOCK HANDRAIL	2000 mm
THERMO PREMIUM – UPPER ESCUTCHEON PROTECTION	DOOR SHORTENING (10, 20, 30, 40, 60, 80, 100 mm)	
KNOB-HANDLE	DOOR TO SIZE, INCREMENTS EVERY 10 mm, Hmax=2400 mm, Smax=1130 mm ONLY WITH ALUTHERM DOOR FRAME	
REED SWITCH	tedee PRO SET	
SIZE 100E	THERMO PREMIUM – RING ESCUTCHEON FOR DOOR WITH HANDRAIL AND MORTISE LOCK	no extra charge

FIXED GLAZED SIDE PANELS: PAGES 94–95, FULL EQUIPMENT LIST: PAGES 98–105

GLASS

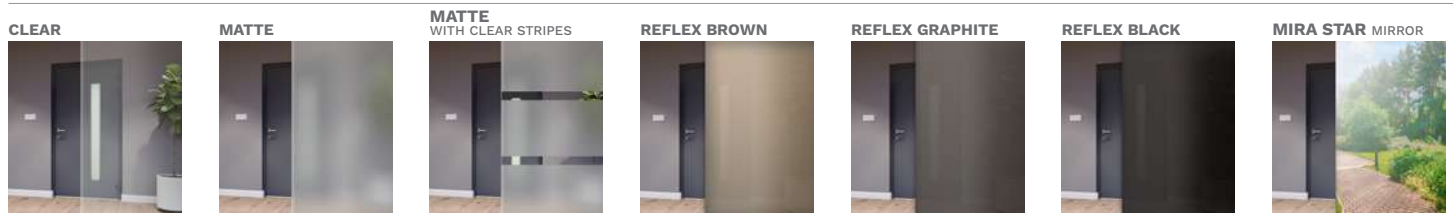

DOOR COLOURS

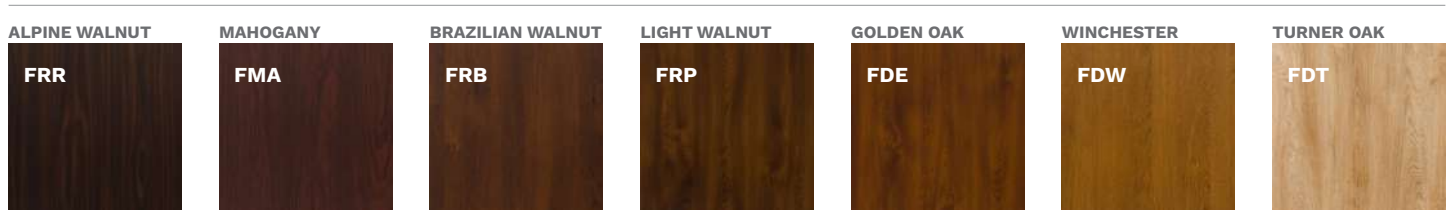



KW4 JENA 4



KW4 JENA 4
INTERNAL SIDE



KW3 JENA 3



KW3 JENA 3
INTERNAL SIDE

standard FITTINGS

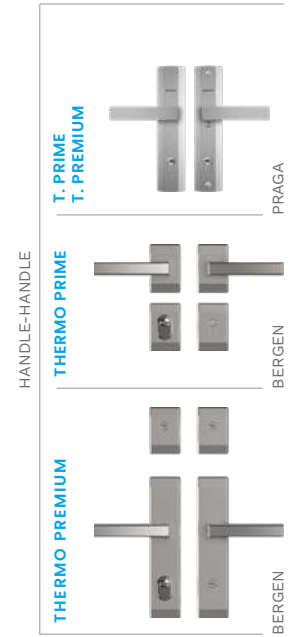

extra charge FITTINGS

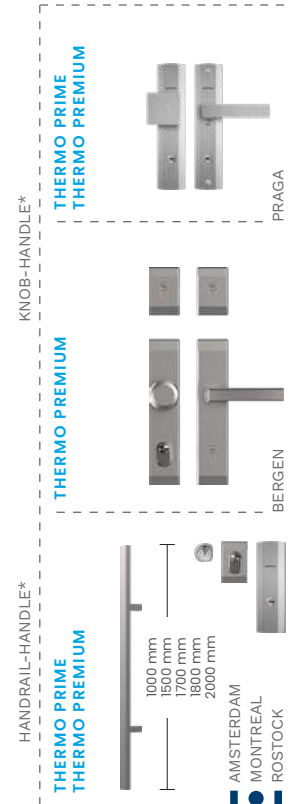

FITTINGS COLOURS

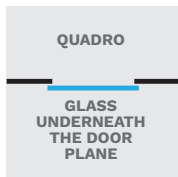
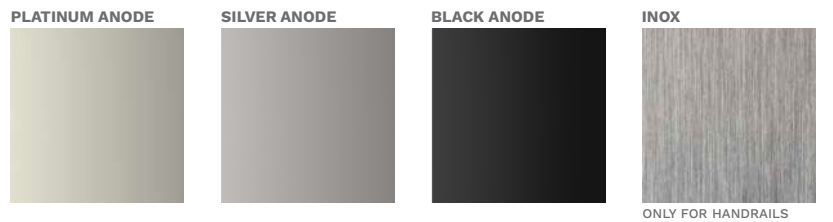

DOOR COLOURS



* EXTRA CHARGE

** FOR GLAZED DOORS RC2N



KWF BAMBERG 1



KWG BAMBERG 2

DOOR SIZE	80	90N	90E	100E*
DOOR HEIGHT (DUOTHERM / ALUTHERM)	2076 mm / 2087 mm			

MODEL	THERMO PREMIUM 60	THERMO PREMIUM 75	THERMO PRIME 75
KWF BAMBERG 1 / KWFB BAMBERG 1 B	✓	✓	✓
KWG BAMBERG 2 / KWGB BAMBERG 2 B	✓	✓	✓
KWH BAMBERG 3 / KWHB BAMBERG 3 B	✓	✓	✓
KWI BAMBERG 4 / KWIB BAMBERG 4 B	✓	✓	✓

RC2 STANDARD EQUIPMENT**

• GLAZED DOOR LEAF	• WARM THRESHOLD WITH SUBTHRESHOLD EXTENSION, h=35 mm
• 4 SIDES REBATED	• FITTINGS SET
• THERMO PREMIUM – DUOTHERM DOOR FRAME	• T. PRIME – LONG ESCUTCHEONS: PRAGA OR SPLIT: BERGEN
• THERMO PRIME – ALUTHERM 75 DOOR FRAME	• THERMO PREMIUM – LONG ESCUTCHEONS: PRAGA OR BERGEN
• HINGES ADJUSTABLE IN THREE PLANES WITH CAPS MATCHING FITTING'S COLOUR	• THERMO PREMIUM – CLASS 5 LOCK CYLINDER, KEYED ALIKE SYSTEM, BOLT LOCK
• QUADRO INSERTS	• THERMO PRIME – CLASS 5 LOCK CYLINDER, 5 POINT HOOK MORTISE LOCK OR 3 POINT AUTOMATIC MORTISE LOCK
• GLASS UNDERNEATH THE DOOR PLANE	
• SINGLE-SIDED DESIGN	

EXTRA CHARGES

POWDER COATING, GALA COLOUR RANGE		✓
POWDER COATING, GALACTICA / GALA OPEN COLOUR RANGE		✓
POWDER COATING, INTERGALACTICA COLOUR RANGE		✓
TWO-COLOUR DOOR, GALA COLOUR RANGE		✓
CUSTOM HEIGHT, INCREMENTS EVERY 50 mm, AVAILABLE COLOURS: FRP, FDE, FDW, FDT, FKG, KFK, FSB, ONLY WITH ALUTHERM DOOR FRAME	2150 mm, 2250 mm, 2350 mm,	2200 mm, 2300 mm, 2400 mm
THERMO PREMIUM – ALUTHERM DOOR FRAME		1800 mm
THERMO PREMIUM – MORTISE LOCK 3-POINT 2-HOOK / AUTOMATIC	AMSTERDAM / MONTREAL HANDRAIL ELECTRIC STRIKE RECOMMENDED	1700 mm 1500 mm
THERMO PREMIUM – AUXILIARY LOCK FOR MORTISE LOCK 2-HOOK		1000 mm
TWO-COLOUR DOOR, TERRA PALETTE	AMSTERDAM / MONTREAL HANDRAIL WITH PUSHBUTTON, WITH DOOR LEAF ADJUSTMENT AND ELECTRIC STRIKE	1800 mm 1700 mm 1500 mm
CLASS 6 LOCK CYLINDERS, KEYED ALIKE SYSTEM		1000 mm
THERMO PREMIUM – UPPER ESCUTCHEON PROTECTION	AMSTERDAM HANDRAIL WITH WIRELESS PUSHBUTTON ELECTRIC STRIKE NECESSARY	1700 mm 1500 mm
KNOB-HANDLE	ROSTOCK HANDRAIL	2000 mm
REED SWITCH	DOOR SHORTENING (10, 20, 30, 40 mm)	
SIZE 100E		
INTEGRATED CLOSER	tedee PRO SET	
ELECTRIC STRIKE WITH DAY / NIGHT FEATURE	THERMO PREMIUM – RING ESCUTCHEON FOR DOOR WITH HANDRAIL AND MORTISE LOCK	no extra charge

FIXED GLAZED SIDE PANELS: PAGES 94–95, FULL EQUIPMENT LIST: PAGES 98–105

GLASS

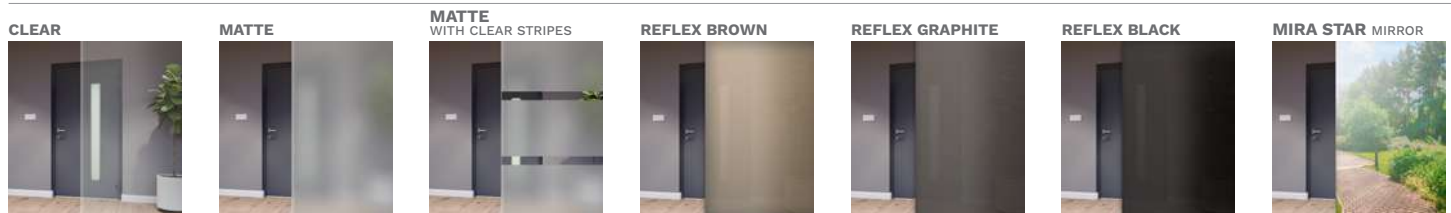

DOOR COLOURS

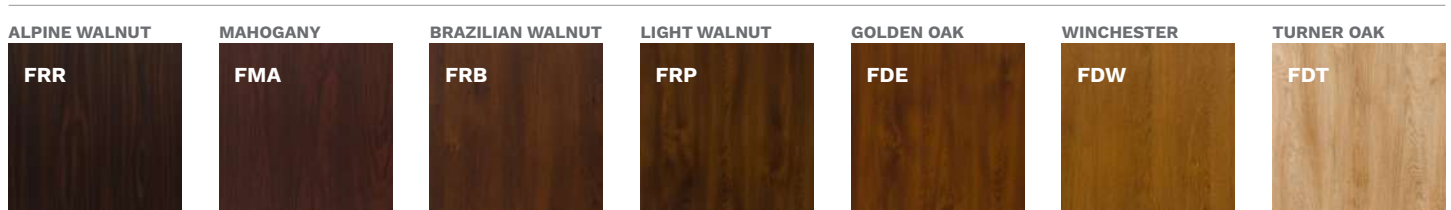



KWH BAMBERG 3



KWI BAMBERG 4



KWI BAMBERG 4
INTERNAL SIDE



KWF BAMBERG 1



KWF BAMBERG 1
INTERNAL SIDE



KWH BAMBERG 3

standard FITTINGS

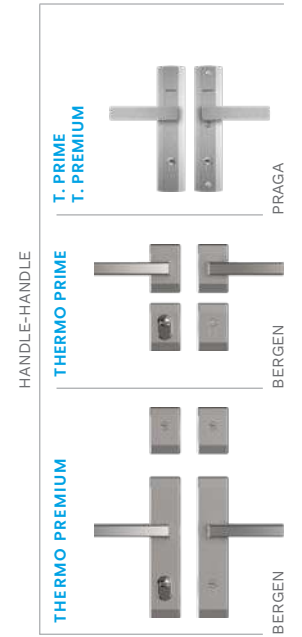

extra charge FITTINGS

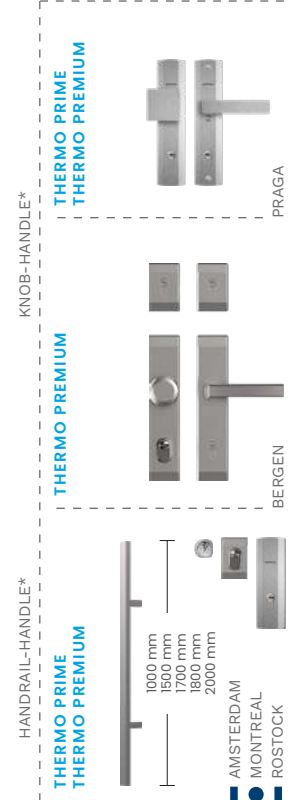

QUADRO INSERT COLOURS



ONLY FOR HANDRAILS

DOOR COLOURS



* EXTRA CHARGE

** FOR GLAZED DOORS RC2N



KWJB ULM 1 B



KWK ULM 2

DOOR SIZE	80	90N	90E	100E*
DOOR HEIGHT (DUOTHERM / ALUTHERM)	2076 mm / 2087 mm			

MODEL	THERMO PREMIUM 60	THERMO PREMIUM 75	THERMO PRIME 75
KWJ ULM 1 / KWJB ULM 1 B	✓	✓	-
KWK ULM 2 / KWKB ULM 2 B	✓	✓	✓

RC2 STANDARD EQUIPMENT**

• GLAZED DOOR LEAF	• WARM THRESHOLD WITH SUBTHRESHOLD EXTENSION, h=35 mm
• 4 SIDES REBATED	• FITTINGS SET
• THERMO PREMIUM – DUOTHERM DOOR FRAME	• T. PRIME – LONG ESCUTCHEONS: PRAGA OR SPLIT: BERGEN
• THERMO PRIME – ALUTHERM 75 DOOR FRAME	• THERMO PREMIUM – LONG ESCUTCHEONS: PRAGA OR BERGEN
• HINGES ADJUSTABLE IN THREE PLANES WITH CAPS MATCHING FITTING'S COLOUR	• THERMO PREMIUM – CLASS 5 LOCK CYLINDER, KEYED ALIKE SYSTEM, BOLT LOCK
• QUADRO INSERTS	• THERMO PRIME – CLASS 5 LOCK CYLINDER, 5 POINT HOOK MORTISE LOCK OR 3 POINT AUTOMATIC MORTISE LOCK
• GLASS UNDERNEATH THE DOOR PLANE	
• SINGLE-SIDED DESIGN	

EXTRA CHARGES

N POWDER COATING, GALA COLOUR RANGE		✓
POWDER COATING, GALACTICA / GALA OPEN COLOUR RANGE		✓
POWDER COATING, INTERGALACTICA COLOUR RANGE		✓
TWO-COLOUR DOOR, GALA COLOUR RANGE		✓
CUSTOM HEIGHT, INCREMENTS EVERY 50 mm, AVAILABLE COLOURS: FRP, FDE, FDW, FDT, FKG, FKF, FSB, ONLY WITH ALUTHERM DOOR FRAME	2150 mm, 2200 mm 2250 mm, 2300 mm 2350 mm, 2400 mm	
THERMO PREMIUM – ALUTHERM DOOR FRAME	1800 mm	
THERMO PREMIUM – MORTISE LOCK 3-POINT 2-HOOK / AUTOMATIC	AMSTERDAM / MONTREAL HANDRAIL 1700 mm ELECTRIC STRIKE RECOMMENDED 1500 mm 1000 mm	
THERMO PREMIUM – AUXILIARY LOCK FOR MORTISE LOCK 2-HOOK	AMSTERDAM / MONTREAL HANDRAIL WITH PUSHBUTTON, WITH DOOR LEAF ADJUSTMENT AND ELECTRIC STRIKE 1800 mm 1700 mm 1500 mm 1000 mm	
TWO-COLOUR DOOR, TERRA PALETTE		
CLASS 6 LOCK CYLINDERS, KEYED ALIKE SYSTEM	AMSTERDAM HANDRAIL WITH WIRELESS PUSHBUTTON ELECTRIC STRIKE NECESSARY 1700 mm 1500 mm	
THERMO PREMIUM – UPPER ESCUTCHEON PROTECTION	ROSTOCK HANDRAIL 2000 mm	
KNOB-HANDLE		
REED SWITCH	DOOR SHORTENING (10, 20, 30, 40, 60, 80, 100 mm)	
SIZE 100E		
INTEGRATED CLOSER	tedee PRO SET	
ELECTRIC STRIKE WITH DAY / NIGHT FEATURE	THERMO PREMIUM – RING ESCUTCHEON FOR DOOR WITH HANDRAIL AND MORTISE LOCK	no extra charge

FIXED GLAZED SIDE PANELS: PAGES 94–95, FULL EQUIPMENT LIST: PAGES 98–105

GLASS



DOOR COLOURS

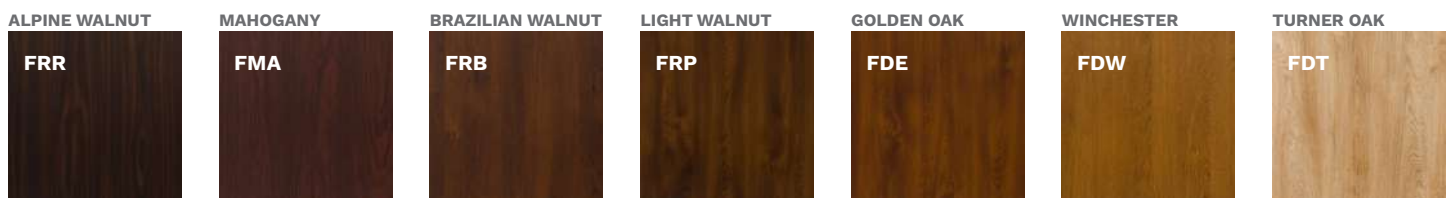



KWJ ULM 1



KWJ ULM 1
INTERNAL SIDE



KWK ULM 2



KWK ULM 2
INTERNAL SIDE

QUADRO INSERT COLOURS

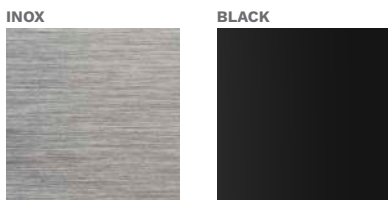

FITTINGS COLOURS

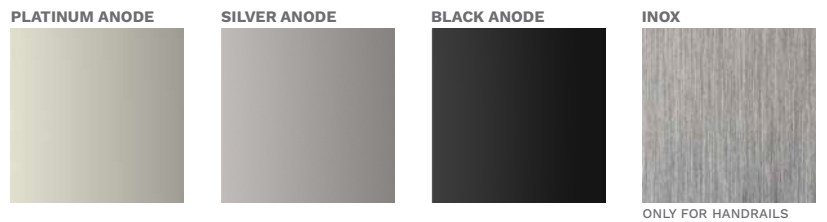

DOOR COLOURS



standard FITTINGS

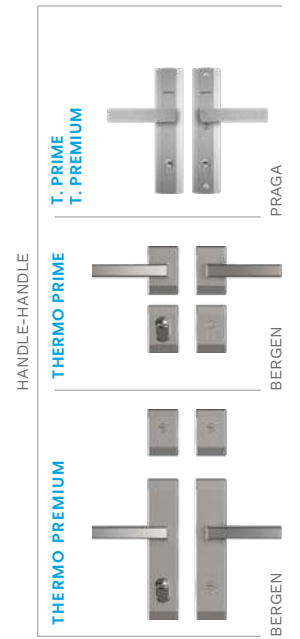

extra charge FITTINGS

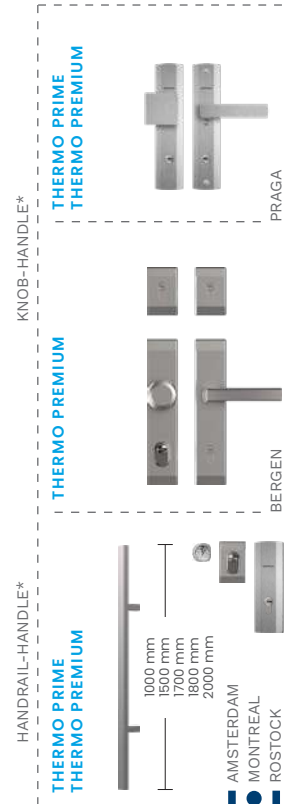

* EXTRA CHARGE

** FOR GLAZED DOORS RC2N



KWL TREWIR 1



KWMB TREWIR 2 B

DOOR SIZE	80	90N	90E	100E*
DOOR HEIGHT (DUOTHERM / ALUTHERM)	2076 mm / 2087 mm			

MODEL	THERMO PREMIUM 60	THERMO PREMIUM 75	THERMO PRIME 75
KWL TREWIR 1 / KWLB TREWIR 1 B	✓	✓	✓
KWM TREWIR 2 / KWMB TREWIR 2 B	✓	✓	✓
KWN TREWIR 3 / KWNB TREWIR 3 B	✓	✓	✓
KWP TREWIR 4 / KWPB TREWIR 4 B	✓	✓	✓
KW7 TREWIR 7 / KW7B TREWIR 7 B	✓	✓	✓

RC2 STANDARD EQUIPMENT**

<ul style="list-style-type: none"> GLAZED DOOR LEAF 4 SIDES REBATED THERMO PREMIUM – DUOTHERM DOOR FRAME THERMO PRIME – ALUTHERM 75 DOOR FRAME HINGES ADJUSTABLE IN THREE PLANES WITH CAPS MATCHING FITTING'S COLOUR QUADRO INSERTS GLASS UNDERNEATH THE DOOR PLANE SINGLE-SIDED DESIGN 	<ul style="list-style-type: none"> WARM THRESHOLD WITH SUBTHRESHOLD EXTENSION, h=35 mm FITTINGS SET T. PRIME – LONG ESCUTCHEONS: PRAGA OR SPLIT: BERGEN THERMO PREMIUM – LONG ESCUTCHEONS: PRAGA OR BERGEN THERMO PREMIUM – CLASS 5 LOCK CYLINDER, KEYED ALIKE SYSTEM, BOLT LOCK THERMO PRIME – CLASS 5 LOCK CYLINDER, 5 POINT HOOK MORTISE LOCK OR 3 POINT AUTOMATIC MORTISE LOCK
-----------------------------------------------------------------------------------------------------------------------------------------------------------------------------------------------------------------------------------------------------------------------------------------------------------------------------------------------------------------------	------------------------------------------------------------------------------------------------------------------------------------------------------------------------------------------------------------------------------------------------------------------------------------------------------------------------------------------------------------------------------------------------------------------------------------------------

EXTRA CHARGES

POWDER COATING, GALA COLOUR RANGE	✓
POWDER COATING, GALACTICA / GALA OPEN COLOUR RANGE	✓
POWDER COATING, INTERGALACTICA COLOUR RANGE	✓
TWO-COLOUR DOOR, GALA COLOUR RANGE	✓
CUSTOM HEIGHT, INCREMENTS EVERY 50 mm, AVAILABLE COLOURS: FRP, FDE, FDW, FDT, FKG, FKF, FSB, ONLY WITH ALUTHERM DOOR FRAME	2150 mm, 2200 mm 2250 mm, 2300 mm 2350 mm, 2400 mm
THERMO PREMIUM – ALUTHERM DOOR FRAME	1800 mm
THERMO PREMIUM – MORTISE LOCK 3-POINT 2-HOOK / AUTOMATIC	AMSTERDAM / MONTREAL HANDRAIL ELECTRIC STRIKE RECOMMENDED 1700 mm 1500 mm 1000 mm
THERMO PREMIUM – AUXILIARY LOCK FOR MORTISE LOCK 2-HOOK	1800 mm
TWO-COLOUR DOOR, TERRA PALETTE	AMSTERDAM / MONTREAL HANDRAIL WITH PUSHBUTTON, WITH DOOR LEAF ADJUSTMENT AND ELECTRIC STRIKE 1700 mm 1500 mm 1000 mm
CLASS 6 LOCK CYLINDERS, KEYED ALIKE SYSTEM	AMSTERDAM HANDRAIL WITH WIRELESS PUSHBUTTON ELECTRIC STRIKE NECESSARY 1700 mm 1500 mm
THERMO PREMIUM – UPPER ESCUTCHEON PROTECTION	ROSTOCK HANDRAIL 2000 mm
KNOB-HANDLE	
REED SWITCH	DOOR SHORTENING (10, 20, 30, 40 mm)
SIZE 100E	
INTEGRATED CLOSER	tedee PRO SET
ELECTRIC STRIKE WITH DAY / NIGHT FEATURE	THERMO PREMIUM – RING ESCUTCHEON FOR DOOR WITH HANDRAIL AND MORTISE LOCK no extra charge

FIXED GLAZED SIDE PANELS: PAGES 94–95, FULL EQUIPMENT LIST: PAGES 98–105

GLASS



DOOR COLOURS

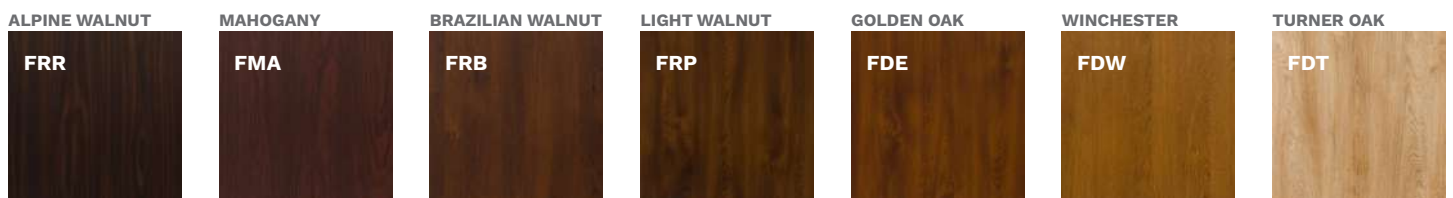



KWN TREWIR 3



KWP TREWIR 4



KW7 TREWIR 7



KWL TREWIR 1



KWL TREWIR 1
INTERNAL SIDE



KWMB TREWIR 2 B

standard FITTINGS

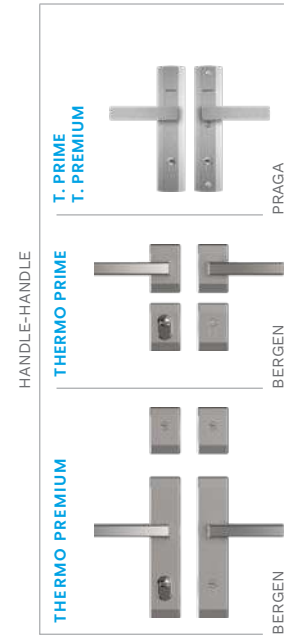

extra charge FITTINGS

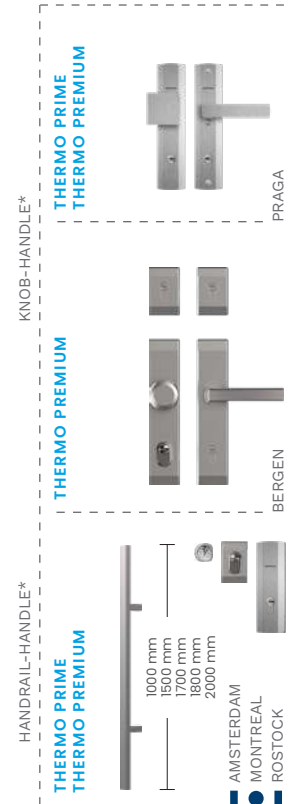

QUADRO INSERT COLOURS

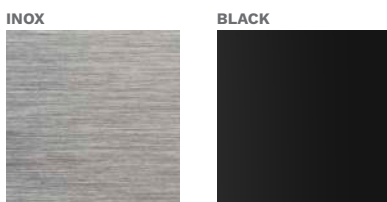

FITTINGS COLOURS

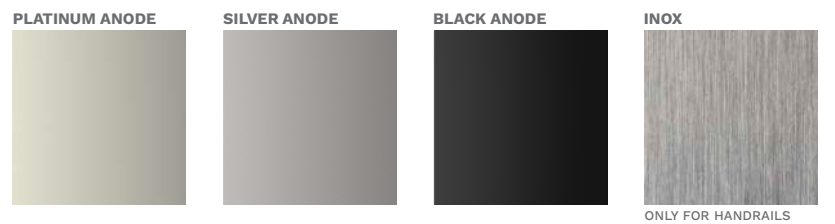

ONLY FOR HANDRAILS

DOOR COLOURS



* EXTRA CHARGE

** FOR GLAZED DOORS RC2N



KWSB DORFEN B



KWS DORFEN

DOOR SIZE	80	90N	90E	100E*
DOOR HEIGHT (DUOTHERM / ALUTHERM)	2076 mm / 2087 mm			
MODEL	THERMO PREMIUM 60	THERMO PREMIUM 75	THERMO PRIME 75	
KWS DORFEN / KWSB DORFEN B	✓	✓	✓	

RC2 STANDARD EQUIPMENT**

- GLAZED DOOR LEAF
- 4 SIDES REBATED
- THERMO PREMIUM – DUOTHERM DOOR FRAME
- THERMO PRIME – ALUTHERM 75 DOOR FRAME
- HINGES ADJUSTABLE IN THREE PLANES WITH CAPS MATCHING FITTING'S COLOUR
- QUADRO INSERTS
- GLASS UNDERNEATH THE DOOR PLANE
- SINGLE-SIDED DESIGN
- WARM THRESHOLD WITH SUBTHRESHOLD EXTENSION, h=35 mm
- FITTINGS SET
- T. PRIME – LONG ESCUTCHEONS: PRAGA OR SPLIT; BERGEN
- THERMO PREMIUM – LONG ESCUTCHEONS: PRAGA OR BERGEN
- THERMO PREMIUM – CLASS 5 LOCK CYLINDER, KEYED ALIKE SYSTEM, BOLT LOCK
- THERMO PRIME – CLASS 5 LOCK CYLINDER, 5 POINT HOOK MORTISE LOCK OR 3 POINT AUTOMATIC MORTISE LOCK

EXTRA CHARGES

N	POWDER COATING, GALA COLOUR RANGE		✓
	POWDER COATING, GALACTICA / GALA OPEN COLOUR RANGE		✓
	POWDER COATING, INTERGALACTICA COLOUR RANGE		✓
	TWO-COLOUR DOOR, GALA COLOUR RANGE		✓
	CUSTOM HEIGHT, INCREMENTS EVERY 50 mm, AVAILABLE COLOURS: FRP, FDE, FDW, FDT, FKG, FKF, FSB, ONLY WITH ALUTHERM DOOR FRAME	2150 mm, 2250 mm, 2350 mm	2200 mm, 2300 mm, 2400 mm
	THERMO PREMIUM – ALUTHERM DOOR FRAME		1800 mm
	THERMO PREMIUM – MORTISE LOCK 3-POINT 2-HOOK / AUTOMATIC	AMSTERDAM / MONTREAL HANDRAIL	1700 mm
	THERMO PREMIUM – AUXILIARY LOCK FOR MORTISE LOCK 2-HOOK	ELECTRIC STRIKE RECOMMENDED	1500 mm
	TWO-COLOUR DOOR, TERRA PALETTE		1000 mm
	CLASS 6 LOCK CYLINDERS, KEYED ALIKE SYSTEM	AMSTERDAM / MONTREAL HANDRAIL WITH PUSHBUTTON, WITH DOOR LEAF ADJUSTMENT AND ELECTRIC STRIKE	1800 mm, 1700 mm, 1500 mm, 1000 mm
	THERMO PREMIUM – UPPER ESCUTCHEON PROTECTION	AMSTERDAM HANDRAIL WITH WIRELESS PUSHBUTTON	1700 mm
	KNOB-HANDLE	ELECTRIC STRIKE NECESSARY	1500 mm
	REED SWITCH	ROSTOCK HANDRAIL	2000 mm
	SIZE 100E	DOOR SHORTENING (10, 20, 30, 40 mm)	
	INTEGRATED CLOSER	tedee PRO SET	
	ELECTRIC STRIKE WITH DAY / NIGHT FEATURE	THERMO PREMIUM – RING ESCUTCHEON FOR DOOR WITH HANDRAIL AND MORTISE LOCK	no extra charge

FIXED GLAZED SIDE PANELS: PAGES 94–95, FULL EQUIPMENT LIST: PAGES 98–105

GLASS



DOOR COLOURS

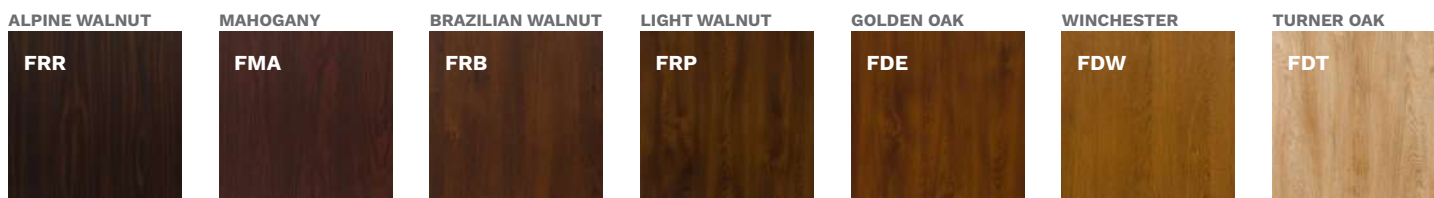



KWS DORFEN



KWS DORFEN
INTERNAL SIDE

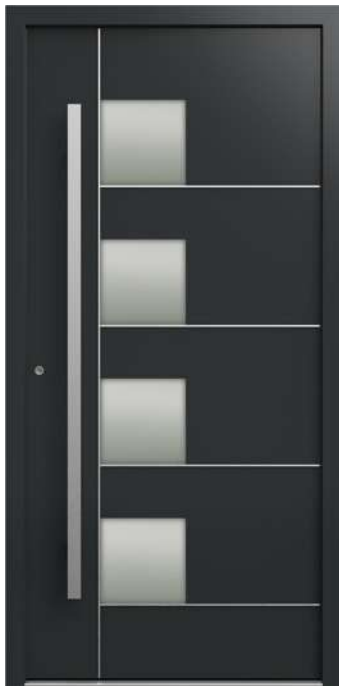

KWS DORFEN



KWS DORFEN
INTERNAL SIDE

QUADRO INSERT COLOURS

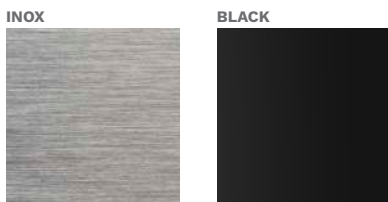

FITTINGS COLOURS

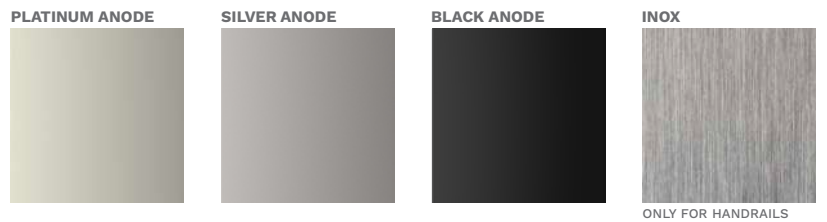

DOOR COLOURS



standard FITTINGS

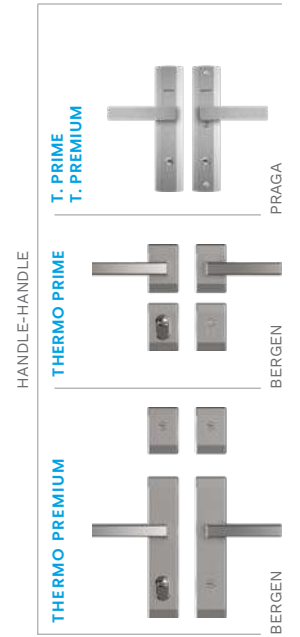

extra charge FITTINGS

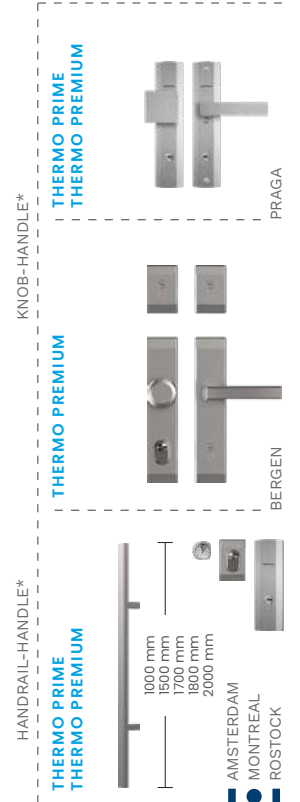

* EXTRA CHARGE

** FOR GLAZED DOORS RC2N



KWT KASSEL 1



KWX KASSEL 2

DOOR SIZE	80	90N	90E	100E*
DOOR HEIGHT (DUOTHERM / ALUTHERM)	2076 mm / 2087 mm			

MODEL	THERMO PREMIUM 60	THERMO PREMIUM 75	THERMO PRIME 75
KWT KASSEL 1 / KWTB KASSEL 1 B	✓	✓	✓
KWX KASSEL 2 / KWXB KASSEL 2 B	✓	✓	✓

RC2 STANDARD EQUIPMENT**

• GLAZED DOOR LEAF	• WARM THRESHOLD WITH SUBTHRESHOLD EXTENSION, h=35 mm
• 4 SIDES REBATED	• FITTINGS SET
• THERMO PREMIUM – DUOTHERM DOOR FRAME	• T. PRIME – LONG ESCUTCHEONS: PRAGA OR SPLIT: BERGEN
• THERMO PRIME – ALUTHERM 75 DOOR FRAME	• THERMO PREMIUM – LONG ESCUTCHEONS: PRAGA OR BERGEN
• HINGES ADJUSTABLE IN THREE PLANES WITH CAPS MATCHING FITTING'S COLOUR	• THERMO PREMIUM – CLASS 5 LOCK CYLINDER, KEYED ALIKE SYSTEM, BOLT LOCK
• QUADRO INSERTS	• THERMO PRIME – CLASS 5 LOCK CYLINDER, 5 POINT HOOK MORTISE LOCK OR 3 POINT AUTOMATIC MORTISE LOCK
• GLASS UNDERNEATH THE DOOR PLANE	
• SINGLE-SIDED DESIGN	

EXTRA CHARGES

N POWDER COATING, GALA COLOUR RANGE		✓
POWDER COATING, GALACTICA / GALA OPEN COLOUR RANGE		✓
POWDER COATING, INTERGALACTICA COLOUR RANGE		✓
TWO-COLOUR DOOR, GALA COLOUR RANGE		✓
CUSTOM HEIGHT, INCREMENTS EVERY 50 mm, AVAILABLE COLOURS: FRP, FDE, FDW, FDT, FKG, FKF, FSB, ONLY WITH ALUTHERM DOOR FRAME	2150 mm, 2200 mm 2250 mm, 2300 mm 2350 mm, 2400 mm	
THERMO PREMIUM – ALUTHERM DOOR FRAME	1800 mm	
THERMO PREMIUM – MORTISE LOCK 3-POINT 2-HOOK / AUTOMATIC	AMSTERDAM / MONTREAL HANDRAIL ELECTRIC STRIKE RECOMMENDED	1700 mm 1500 mm 1000 mm
THERMO PREMIUM – AUXILIARY LOCK FOR MORTISE LOCK 2-HOOK	AMSTERDAM / MONTREAL HANDRAIL WITH PUSHBUTTON, WITH DOOR LEAF ADJUSTMENT AND ELECTRIC STRIKE	1800 mm 1700 mm 1500 mm 1000 mm
TWO-COLOUR DOOR, TERRA PALETTE		
CLASS 6 LOCK CYLINDERS, KEYED ALIKE SYSTEM	AMSTERDAM HANDRAIL WITH WIRELESS PUSHBUTTON ELECTRIC STRIKE NECESSARY	1700 mm 1500 mm
THERMO PREMIUM – UPPER ESCUTCHEON PROTECTION	ROSTOCK HANDRAIL	2000 mm
KNOB-HANDLE		
REED SWITCH	DOOR SHORTENING (10, 20, 30, 40 mm)	
SIZE 100E		
INTEGRATED CLOSER	tedee PRO SET	
ELECTRIC STRIKE WITH DAY / NIGHT FEATURE	THERMO PREMIUM – RING ESCUTCHEON FOR DOOR WITH HANDRAIL AND MORTISE LOCK	no extra charge

FIXED GLAZED SIDE PANELS: PAGES 94–95, FULL EQUIPMENT LIST: PAGES 98–105

GLASS



DOOR COLOURS

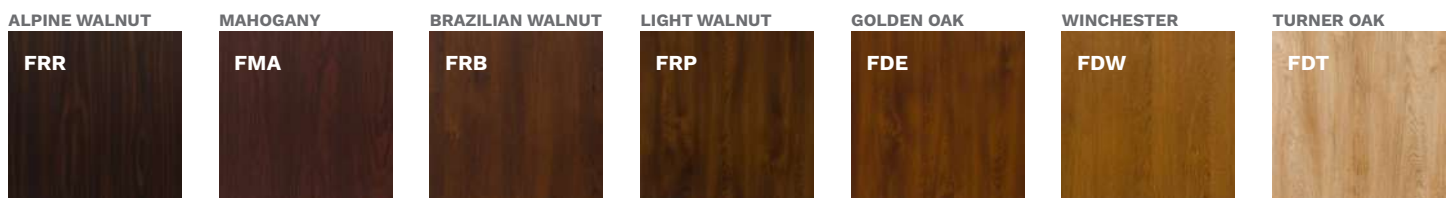



KWXB KASSEL 2 B



KWXB KASSEL 2 B



KWXB KASSEL 2 B
INTERNAL SIDE



KWT KASSEL 1



KWT KASSEL 1
INTERNAL SIDE



KWT KASSEL 1

standard FITTINGS

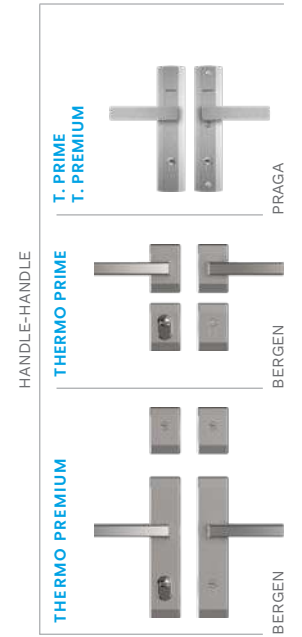

extra charge FITTINGS

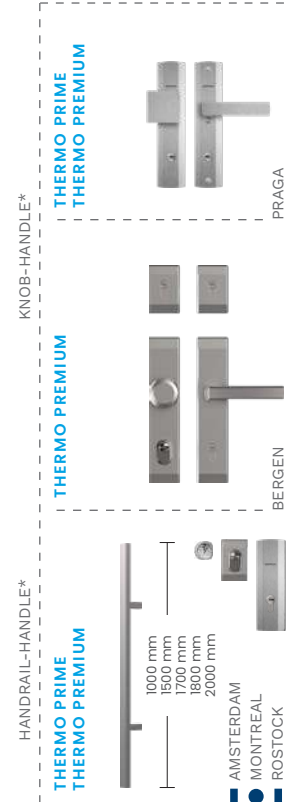

QUADRO INSERT COLOURS

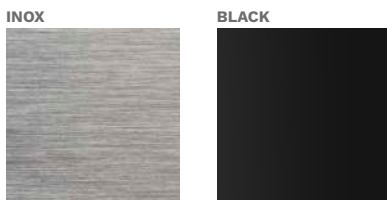

FITTINGS COLOURS

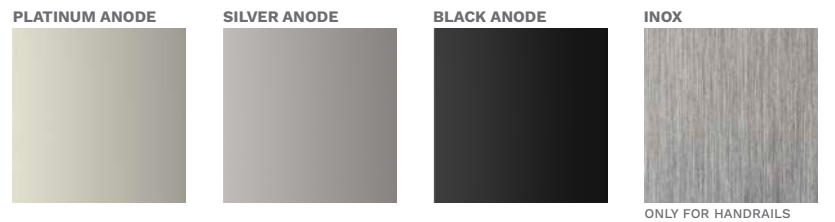

ONLY FOR HANDRAILS

DOOR COLOURS



* EXTRA CHARGE

** FOR GLAZED DOORS RC2N



KPN KRONACH 1



KPPB KRONACH 2 B

DOOR SIZE	80	90N	90E	100E*
DOOR HEIGHT (DUOTHERM / ALUTHERM)	2076 mm / 2087 mm			

MODEL	THERMO PREMIUM 60	THERMO PREMIUM 75	THERMO PRIME 75
KPN KRONACH 1 / KPNB KRONACH 1 B	✓	✓	✓
KPP KRONACH 2 / KPPB KRONACH 2 B	✓	✓	✓
KPT KRONACH 3 / KPTB KRONACH 3 B	✓	✓	-
KPZ KRONACH 4 / KPZB KRONACH 4 B	✓	✓	-

RC2 STANDARD EQUIPMENT**

• SOLID DOOR LEAF	• WARM THRESHOLD WITH SUBTHRESHOLD EXTENSION, h=35 mm
• 4 SIDES REBATED	• FITTINGS SET
• THERMO PREMIUM – DUOTHERM DOOR FRAME • THERMO PRIME – ALUTHERM 75 DOOR FRAME	• T. PRIME – LONG ESCUTCHEONS: PRAGA OR SPLIT: BERGEN • THERMO PREMIUM – LONG ESCUTCHEONS: PRAGA OR BERGEN
• HINGES ADJUSTABLE IN THREE PLANES WITH CAPS MATCHING FITTING'S COLOUR	• THERMO PREMIUM – CLASS 5 LOCK CYLINDER, KEYED ALIKE SYSTEM, BOLT LOCK
• QUADRO INSERTS • SINGLE-SIDED DESIGN	• THERMO PRIME – CLASS 5 LOCK CYLINDER, 5 POINT HOOK MORTISE LOCK OR 3 POINT AUTOMATIC MORTISE LOCK

EXTRA CHARGES

N POWDER COATING, GALA COLOUR RANGE		✓
POWDER COATING, GALACTICA / GALA OPEN COLOUR RANGE		✓
POWDER COATING, INTERGALACTICA COLOUR RANGE		✓
TWO-COLOUR DOOR, GALA COLOUR RANGE		✓
CUSTOM HEIGHT, INCREMENTS EVERY 50 mm, AVAILABLE COLOURS: FRP, FDE, FDW, FDT, FKG, FKF, FSB, ONLY WITH ALUTHERM DOOR FRAME	2150 mm, 2200 mm 2250 mm, 2300 mm 2350 mm, 2400 mm	
THERMO PREMIUM – ALUTHERM DOOR FRAME		1800 mm
THERMO PREMIUM – MORTISE LOCK 3-POINT 2-HOOK / AUTOMATIC	AMSTERDAM / MONTREAL HANDRAIL ELECTRIC STRIKE RECOMMENDED	1700 mm 1500 mm
THERMO PREMIUM – AUXILIARY LOCK FOR MORTISE LOCK 2-HOOK		1000 mm
TWO-COLOUR DOOR, TERRA PALETTE	AMSTERDAM / MONTREAL HANDRAIL WITH PUSHBUTTON, WITH DOOR LEAF ADJUSTMENT AND ELECTRIC STRIKE	1800 mm 1700 mm 1500 mm
RC3 PACKAGE		1000 mm
CLASS 6 LOCK CYLINDERS, KEYED ALIKE SYSTEM		1800 mm
THERMO PREMIUM – UPPER ESCUTCHEON PROTECTION	AMSTERDAM HANDRAIL WITH WIRELESS PUSHBUTTON ELECTRIC STRIKE NECESSARY	1700 mm 1500 mm
KNOB-HANDLE		
REED SWITCH	ROSTOCK HANDRAIL	2000 mm
SIZE 100E	DOOR SHORTENING (10, 20, 30, 40 mm)	
INSERT AND APPLICATION – OPPOSITE SIDE		
INSERT – OPPOSITE SIDE	tedee PRO SET	
INTEGRATED CLOSER	THERMO PREMIUM – RING ESCUTCHEON FOR DOOR WITH HANDRAIL AND MORTISE LOCK	no extra charge
ELECTRIC STRIKE WITH DAY / NIGHT FEATURE		

FIXED GLAZED SIDE PANELS: PAGES 94–95, FULL EQUIPMENT LIST: PAGES 98–105

DOOR COLOURS

ALPINE WALNUT	MAHOGANY	BRAZILIAN WALNUT	LIGHT WALNUT	GOLDEN OAK	WINCHESTER	TURNER OAK
FRR	FMA	FRB	FRP	FDE	FDW	FDT



KPT KRONACH 3



KPZ KRONACH 4



KRONACH
INTERNAL SIDE



KPN KRONACH 1



KRONACH
INTERNAL SIDE



KPP KRONACH 2

standard FITTINGS

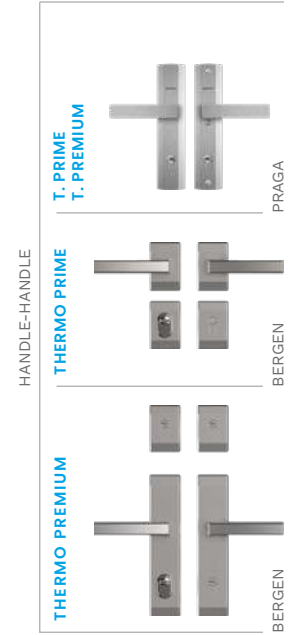

extra charge FITTINGS

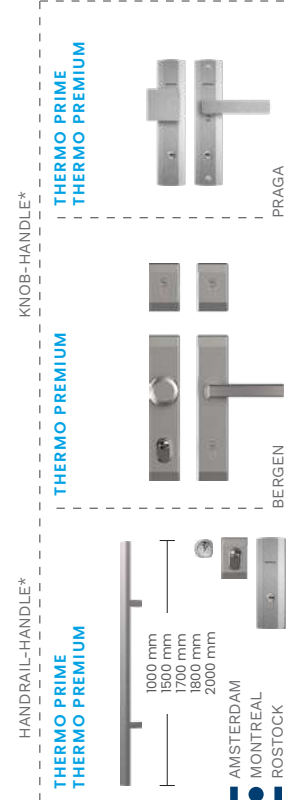

QUADRO INSERT COLOURS



DOOR COLOURS



* EXTRA CHARGE

** FOR GLAZED DOORS RC2N



KPJ REGEN 1



KPK REGEN 2

DOOR SIZE	80	90N	90E	100E*
DOOR HEIGHT (DUOTHERM / ALUTHERM)	2076 mm / 2087 mm			

MODEL	THERMO PREMIUM 60	THERMO PREMIUM 75	THERMO PRIME 75
KPJ REGEN 1 / KPJB REGEN 1 B	✓	✓	✓
KPK REGEN 2 / KPKB REGEN 2 B	✓	✓	✓
KPL REGEN 3 / KPLB REGEN 3 B	✓	✓	✓
KPS REGEN 4 / KPSB REGEN 4 B	✓	✓	✓
KPM REGEN 5 / KPMB REGEN 5 B	✓	✓	✓
KPR REGEN 6 / KPRB REGEN 6 B	✓	✓	✓

RC2 STANDARD EQUIPMENT**

• SOLID DOOR LEAF	• WARM THRESHOLD WITH SUBTHRESHOLD EXTENSION, h=35 mm
• 4 SIDES REBATED	• FITTINGS SET
• THERMO PREMIUM – DUOTHERM DOOR FRAME	• T. PRIME – LONG ESCUTCHEONS: PRAGA OR SPLIT: BERGEN
• THERMO PRIME – ALUTHERM 75 DOOR FRAME	• THERMO PREMIUM – LONG ESCUTCHEONS: PRAGA OR BERGEN
• HINGES ADJUSTABLE IN THREE PLANES WITH CAPS MATCHING FITTING'S COLOUR	• THERMO PREMIUM – CLASS 5 LOCK CYLINDER, KEYED ALIKE SYSTEM, BOLT LOCK
• QUADRO INSERTS	• THERMO PRIME – CLASS 5 LOCK CYLINDER, 5 POINT HOOK MORTISE LOCK OR 3 POINT AUTOMATIC MORTISE LOCK
• SINGLE-SIDED DESIGN	

EXTRA CHARGES

POWDER COATING, GALA COLOUR RANGE	✓
N POWDER COATING, GALACTICA / GALA OPEN COLOUR RANGE	✓
POWDER COATING, INTERGALACTICA COLOUR RANGE	✓
TWO-COLOUR DOOR, GALA COLOUR RANGE	✓
CUSTOM HEIGHT, INCREMENTS EVERY 50 mm, AVAILABLE COLOURS: FRP, FDE, FDW, FDT, FKG, FKF, FSB, ONLY WITH ALUTHERM DOOR FRAME	2150 mm, 2200 mm 2250 mm, 2300 mm 2350 mm, 2400 mm
THERMO PREMIUM – ALUTHERM DOOR FRAME	1800 mm
THERMO PREMIUM – MORTISE LOCK 3-POINT 2-HOOK / AUTOMATIC	AMSTERDAM / MONTREAL HANDRAIL 1700 mm ELECTRIC STRIKE RECOMMENDED 1500 mm
THERMO PREMIUM – AUXILIARY LOCK FOR MORTISE LOCK 2-HOOK	1000 mm
TWO-COLOUR DOOR, TERRA PALETTE	1800 mm
RC3 PACKAGE	AMSTERDAM / MONTREAL HANDRAIL WITH PUSHBUTTON, WITH DOOR LEAF ADJUSTMENT AND ELECTRIC STRIKE 1700 mm 1500 mm
CLASS 6 LOCK CYLINDERS, KEYED ALIKE SYSTEM	1000 mm
THERMO PREMIUM – UPPER ESCUTCHEON PROTECTION	
KNOB-HANDLE	AMSTERDAM HANDRAIL WITH WIRELESS PUSHBUTTON 1700 mm ELECTRIC STRIKE NECESSARY 1500 mm
REED SWITCH	
SIZE 100E	ROSTOCK HANDRAIL 2000 mm
INSERT AND APPLICATION – OPPOSITE SIDE	DOOR SHORTENING (10, 20, 30, 40 mm)
INSERT – OPPOSITE SIDE	tedee PRO SET
INTEGRATED CLOSER	
ELECTRIC STRIKE WITH DAY / NIGHT FEATURE	THERMO PREMIUM – RING ESCUTCHEON FOR DOOR WITH HANDRAIL AND MORTISE LOCK no extra charge

FIXED GLAZED SIDE PANELS: PAGES 94–95, FULL EQUIPMENT LIST: PAGES 98–105

DOOR COLOURS

ALPINE WALNUT	MAHOGANY	BRAZILIAN WALNUT	LIGHT WALNUT	GOLDEN OAK	WINCHESTER	TURNER OAK
FRR	FMA	FRB	FRP	FDE	FDW	FDT



KPL REGEN 3



KPS REGEN 4



KPM REGEN 5



KPRB REGEN 6 B



KPJ REGEN 1



REGEN
INTERNAL SIDE

standard FITTINGS

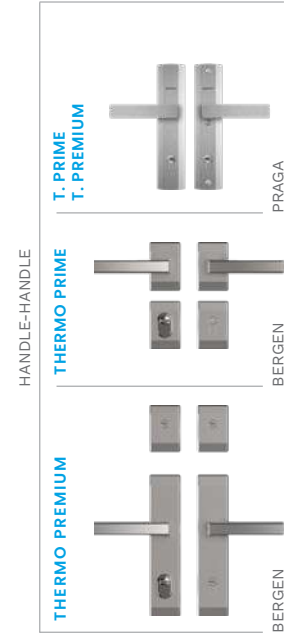

extra charge FITTINGS

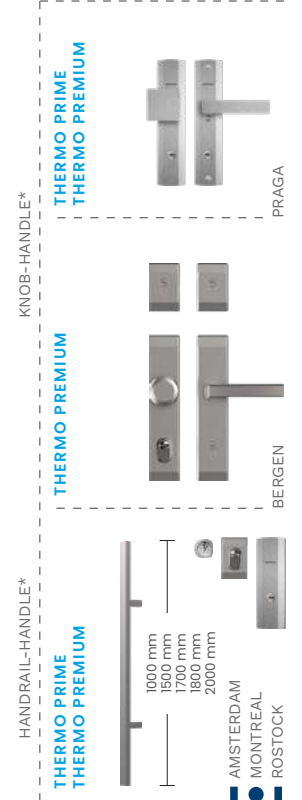

QUADRO INSERT COLOURS



DOOR COLOURS



* EXTRA CHARGE

** FOR GLAZED DOORS RC2N



KPE DREZNO 1



KPFB DREZNO 2 B

DOOR SIZE	80	90N	90E	100E*
DOOR HEIGHT (DUOTHERM / ALUTHERM)	2076 mm / 2087 mm			

MODEL	THERMO PREMIUM 60	THERMO PREMIUM 75	THERMO PRIME 75
KPE DREZNO 1 / KPFB DREZNO 1 B	✓	✓	-
KPF DREZNO 2 / KPFB DREZNO 2 B	✓	✓	-
KPH DREZNO 4 / KPHB DREZNO 4 B	✓	✓	✓

RC2 STANDARD EQUIPMENT**

• SOLID DOOR LEAF	• WARM THRESHOLD WITH SUBTHRESHOLD EXTENSION, h=35 mm
• 4 SIDES REBATED	• FITTINGS SET
• THERMO PREMIUM – DUOTHERM DOOR FRAME	• T. PRIME – LONG ESCUTCHEONS: PRAGA OR SPLIT: BERGEN
• THERMO PRIME – ALUTHERM 75 DOOR FRAME	• THERMO PREMIUM – LONG ESCUTCHEONS: PRAGA OR BERGEN
• HINGES ADJUSTABLE IN THREE PLANES WITH CAPS MATCHING FITTING'S COLOUR	• THERMO PREMIUM – CLASS 5 LOCK CYLINDER, KEYED ALIKE SYSTEM, BOLT LOCK
• QUADRO INSERTS	• THERMO PRIME – CLASS 5 LOCK CYLINDER, 5 POINT HOOK MORTISE LOCK OR 3 POINT AUTOMATIC MORTISE LOCK
• SINGLE-SIDED DESIGN	

EXTRA CHARGES

POWDER COATING, GALA COLOUR RANGE		✓
POWDER COATING, GALACTICA / GALA OPEN COLOUR RANGE		✓
POWDER COATING, INTERGALACTICA COLOUR RANGE		✓
TWO-COLOUR DOOR, GALA COLOUR RANGE		✓
CUSTOM HEIGHT, INCREMENTS EVERY 50 mm, AVAILABLE COLOURS: FRP, FDE, FDW, FDT, FKG, FKF, FSB, ONLY WITH ALUTHERM DOOR FRAME	2150 mm, 2200 mm 2250 mm, 2300 mm 2350 mm, 2400 mm	
THERMO PREMIUM – ALUTHERM DOOR FRAME		1800 mm
THERMO PREMIUM – MORTISE LOCK 3-POINT 2-HOOK / AUTOMATIC	AMSTERDAM / MONTREAL HANDRAIL ELECTRIC STRIKE RECOMMENDED	1700 mm 1500 mm
THERMO PREMIUM – AUXILIARY LOCK FOR MORTISE LOCK 2-HOOK		1000 mm
TWO-COLOUR DOOR, TERRA PALETTE	AMSTERDAM / MONTREAL HANDRAIL WITH PUSHBUTTON, WITH DOOR LEAF ADJUSTMENT AND ELECTRIC STRIKE	1800 mm 1700 mm 1500 mm
RC3 PACKAGE		1000 mm
CLASS 6 LOCK CYLINDERS, KEYED ALIKE SYSTEM		
THERMO PREMIUM – UPPER ESCUTCHEON PROTECTION	AMSTERDAM HANDRAIL WITH WIRELESS PUSHBUTTON ELECTRIC STRIKE NECESSARY	1700 mm 1500 mm
KNOB-HANDLE	ROSTOCK HANDRAIL	2000 mm
REED SWITCH	DOOR SHORTENING KPH (10, 20, 30, 40 mm) KPE, KPF (10, 20, 30, 40, 60, 80, 100 mm)	
SIZE 100E		
INSERT – OPPOSITE SIDE	tedee PRO SET	
INTEGRATED CLOSER	THERMO PREMIUM – RING ESCUTCHEON FOR DOOR WITH HANDRAIL AND MORTISE LOCK	no extra charge
ELECTRIC STRIKE WITH DAY / NIGHT FEATURE		

FIXED GLAZED SIDE PANELS: PAGES 94–95, FULL EQUIPMENT LIST: PAGES 98–105

DOOR COLOURS

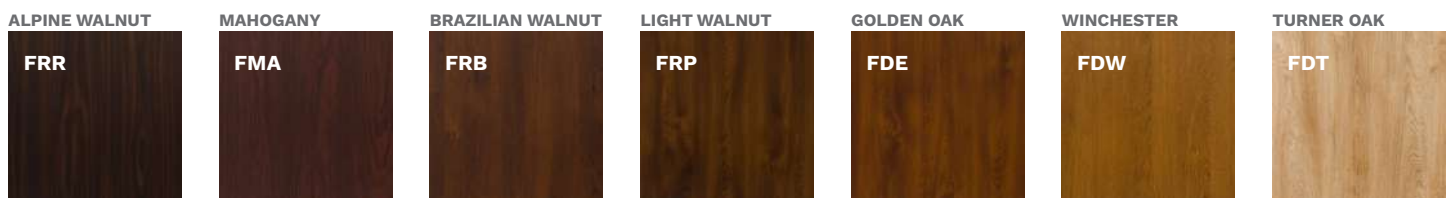



KPH DREZNO 4



DREZNO
INTERNAL SIDE



KPF DREZNO 2



KPH DREZNO 4



DREZNO
INTERNAL SIDE

standard FITTINGS

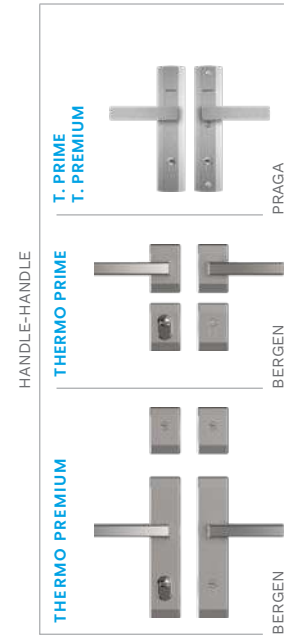

extra charge FITTINGS

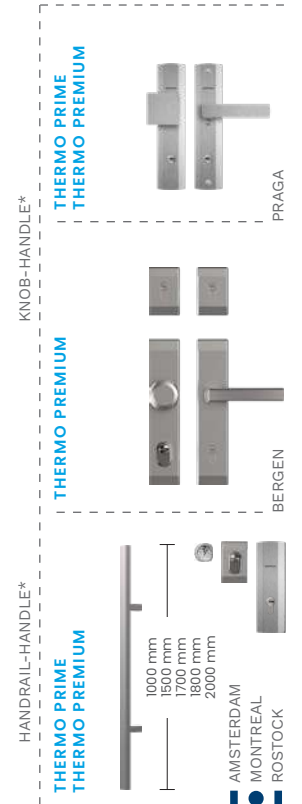

QUADRO INSERT COLOURS



DOOR COLOURS



* EXTRA CHARGE

** FOR GLAZED DOORS RC2N



KPAB ERFURT 1 B



KPB ERFURT 2

DOOR SIZE	80	90N	90E	100E*
DOOR HEIGHT (DUOTHERM / ALUTHERM)	2076 mm / 2087 mm			

MODEL	THERMO PREMIUM 60	THERMO PREMIUM 75	THERMO PRIME 75
KPA ERFURT 1 / KPAB ERFURT 1 B	✓	✓	✓
KPB ERFURT 2 / KPBB ERFURT 2 B	✓	✓	✓
KPC ERFURT 3 / KPCB ERFURT 3 B	✓	✓	✓

RC2 STANDARD EQUIPMENT**

• SOLID DOOR LEAF	• WARM THRESHOLD WITH SUBTHRESHOLD EXTENSION, h=35 mm
• 4 SIDES REBATED	• FITTINGS SET
• THERMO PREMIUM – DUOTHERM DOOR FRAME	• T. PRIME – LONG ESCUTCHEONS: PRAGA OR SPLIT: BERGEN
• THERMO PRIME – ALUTHERM 75 DOOR FRAME	• THERMO PREMIUM – LONG ESCUTCHEONS: PRAGA OR BERGEN
• HINGES ADJUSTABLE IN THREE PLANES WITH CAPS MATCHING FITTING'S COLOUR	• THERMO PREMIUM – CLASS 5 LOCK CYLINDER, KEYED ALIKE SYSTEM, BOLT LOCK
• QUADRO INSERTS	• THERMO PRIME – CLASS 5 LOCK CYLINDER, 5 POINT HOOK MORTISE LOCK OR 3 POINT AUTOMATIC MORTISE LOCK
• SINGLE-SIDED DESIGN	

EXTRA CHARGES

POWDER COATING, GALA COLOUR RANGE		✓
POWDER COATING, GALACTICA / GALA OPEN COLOUR RANGE		✓
POWDER COATING, INTERGALACTICA COLOUR RANGE		✓
TWO-COLOUR DOOR, GALA COLOUR RANGE		✓
CUSTOM HEIGHT, INCREMENTS EVERY 50 mm, AVAILABLE COLOURS: FRP, FDE, FDW, FDT, FKG, FKf, FSB, ONLY WITH ALUTHERM DOOR FRAME	2150 mm, 2200 mm 2250 mm, 2300 mm 2350 mm, 2400 mm	
THERMO PREMIUM – ALUTHERM DOOR FRAME		1800 mm
THERMO PREMIUM – MORTISE LOCK 3-POINT 2-HOOK / AUTOMATIC	AMSTERDAM / MONTREAL HANDRAIL ELECTRIC STRIKE RECOMMENDED	1700 mm
THERMO PREMIUM – AUXILIARY LOCK FOR MORTISE LOCK 2-HOOK		1500 mm
		1000 mm
TWO-COLOUR DOOR, TERRA PALETTE		1800 mm
RC3 PACKAGE	AMSTERDAM / MONTREAL HANDRAIL WITH PUSHBUTTON, WITH DOOR LEAF ADJUSTMENT AND ELECTRIC STRIKE	1700 mm
CLASS 6 LOCK CYLINDERS, KEYED ALIKE SYSTEM		1500 mm
		1000 mm
THERMO PREMIUM – UPPER ESCUTCHEON PROTECTION		1800 mm
KNOB-HANDLE	AMSTERDAM HANDRAIL WITH WIRELESS PUSHBUTTON ELECTRIC STRIKE NECESSARY	1700 mm
		1500 mm
REED SWITCH		2000 mm
SIZE 100E		
INSERT – OPPOSITE SIDE	ROSTOCK HANDRAIL	
INTEGRATED CLOSER	DOOR SHORTENING (10, 20, 30, 40 mm)	
ELECTRIC STRIKE WITH DAY / NIGHT FEATURE	tedee PRO SET	
	THERMO PREMIUM – RING ESCUTCHEON FOR DOOR WITH HANDRAIL AND MORTISE LOCK	no extra charge

FIXED GLAZED SIDE PANELS: PAGES 94–95, FULL EQUIPMENT LIST: PAGES 98–105

DOOR COLOURS

ALPINE WALNUT	MAHOGANY	BRAZILIAN WALNUT	LIGHT WALNUT	GOLDEN OAK	WINCHESTER	TURNER OAK
FRR	FMA	FRB	FRP	FDE	FDW	FDT



KPC ERFURT 3



ERFURT
INTERNAL SIDE



KPA ERFURT 1



KPA ERFURT 1



ERFURT
INTERNAL SIDE



KPAB ERFURT 1 B

standard FITTINGS

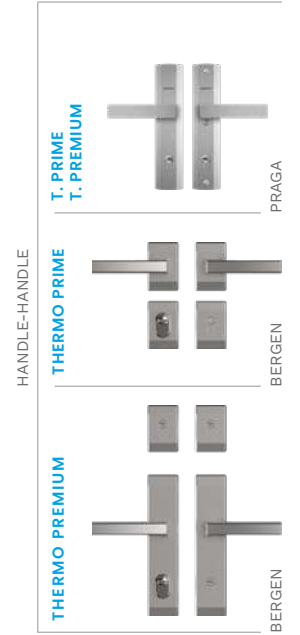

extra charge FITTINGS

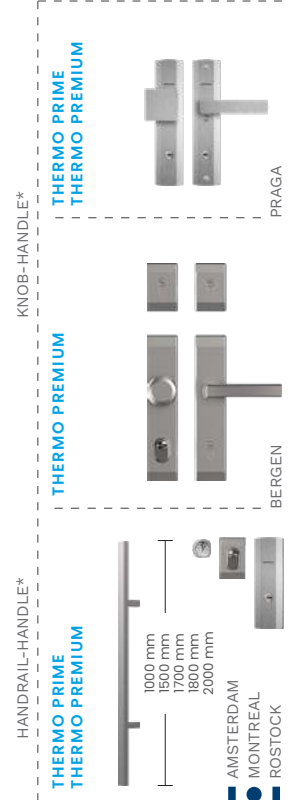

QUADRO INSERT COLOURS



DOOR COLOURS



* EXTRA CHARGE

** FOR GLAZED DOORS RC2N



ELF DAVOS



ELA BRIG

DOOR SIZE	80	90N	90E	100E*
DOOR HEIGHT (DUOTHERM / ALUTHERM)	2076 mm / 2087 mm			

MODEL	THERMO PREMIUM 60	THERMO PREMIUM 75	THERMO PRIME 75
ELF DAVOS	✓	✓	✓
ELA BRIG	✓	✓	✓
ELB OLTEN	✓	✓	✓
ELC VISP	✓	✓	✓
ELD TRIN	✓	✓	✓
ELE BERNO	✓	✓	✓

RC2 STANDARD EQUIPMENT**

- SOLID DOOR LEAF
- 4 SIDES REBATED
- THERMO PREMIUM – DUOTHERM DOOR FRAME
- THERMO PRIME – ALUTHERM 75 DOOR FRAME
- HINGES ADJUSTABLE IN THREE PLANES WITH CAPS MATCHING FITTING'S COLOUR
- ELITE FRAMES
- SINGLE-SIDED DESIGN
- WARM THRESHOLD WITH SUBTHRESHOLD EXTENSION, h=35 mm
- FITTINGS SET
- T. PRIME – LONG ESCUTCHEONS: PRAGA OR SPLIT: BERGEN
- THERMO PREMIUM – LONG ESCUTCHEONS: PRAGA OR BERGEN
- THERMO PREMIUM – CLASS 5 LOCK CYLINDER, KEYED ALIKE SYSTEM, BOLT LOCK
- THERMO PRIME – CLASS 5 LOCK CYLINDER, 5 POINT HOOK MORTISE LOCK OR 3 POINT AUTOMATIC MORTISE LOCK

EXTRA CHARGES

POWDER COATING, GALA COLOUR RANGE	✓
N POWDER COATING, GALACTICA / GALA OPEN COLOUR RANGE	✓
POWDER COATING, INTERGALACTICA COLOUR RANGE	✓
TWO-COLOUR DOOR, GALA COLOUR RANGE	✓
CUSTOM HEIGHT, INCREMENTS EVERY 50 mm, AVAILABLE COLOURS: FRP, FDE, FDW, FDT, FKG, FKF, FSB, ONLY WITH ALUTHERM DOOR FRAME	2150 mm, 2200 mm 2250 mm, 2300 mm 2350 mm, 2400 mm
THERMO PREMIUM – ALUTHERM DOOR FRAME	REED SWITCH
THERMO PREMIUM – MORTISE LOCK 3-POINT 2-HOOK / AUTOMATIC (NOT AVAILABLE FOR ELF)	SIZE 100E
THERMO PREMIUM – AUXILIARY LOCK FOR MORTISE LOCK 2-HOOK	FRAME – OPPOSITE SIDE
TWO-COLOUR DOOR, TERRA PALETTE	INTEGRATED CLOSER
RC3 PACKAGE	ELECTRIC STRIKE WITH DAY / NIGHT FEATURE
CLASS 6 LOCK CYLINDERS, KEYED ALIKE SYSTEM	DOOR SHORTENING (10, 20, 30, 40 mm)
THERMO PREMIUM – UPPER ESCUTCHEON PROTECTION	tedee PRO SET
KNOB-HANDLE	

FIXED GLAZED SIDE PANELS: PAGES 94–95, FULL EQUIPMENT LIST: PAGES 98–105

DOOR COLOURS

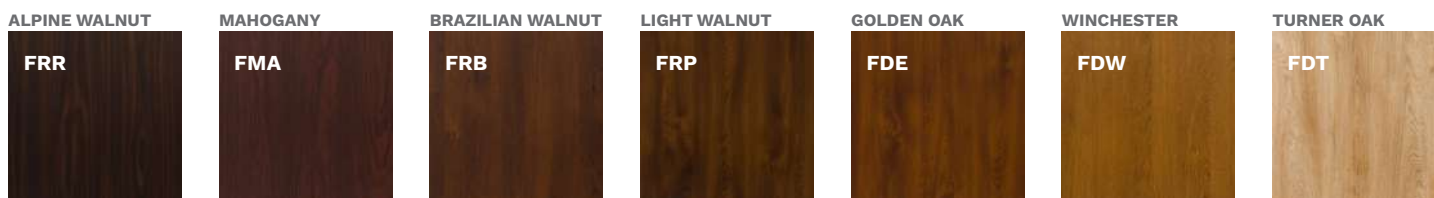



ELB OLTEN



ELC VISP



ELD TRIN



ELE BERNO



ELA BRIG



ELA BRIG
INTERNAL SIDE

standard FITTINGS

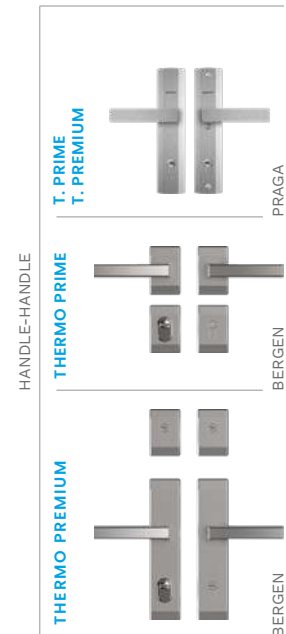

extra charge FITTINGS

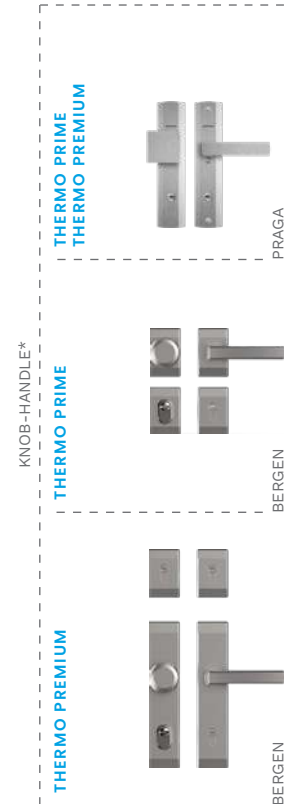

ELITE FRAMES

CLASSIC



MODERN



FITTINGS COLOURS

PLATINUM ANODE



SILVER ANODE



BLACK ANODE



DOOR COLOURS

LIGHT WENGE



WHITE



STEEL GRAY

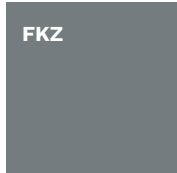

ANTHRACITE

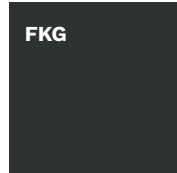

DARK ANTHRACITE

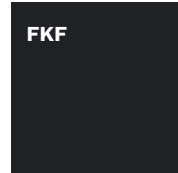

BLACK

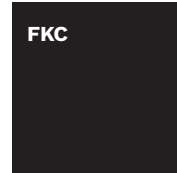

TWO-COLOUR DOOR*



* EXTRA CHARGE

** FOR GLAZED DOORS RC2N



NS1B MILANO 8 B



NS2 MILANO 9

DOOR SIZE (THERMO PRIME, THERMO PREMIUM)	-	80	90N	90E	100E*
DOOR HEIGHT (DUOTHERM, PERFOTHERM / ALUTHERM)	2076 mm / 2087-2400 mm				
DOOR SIZE (OPTIMA)	80N	80	90N	90E	100E*

MODEL	OPTIMA 60	THERMO PREMIUM 60	THERMO PREMIUM 75	THERMO PRIME 75
NS1 MILANO 8 / NS1B MILANO 8 B	✓	✓	✓	✓
NS2 MILANO 9 / NS2B MILANO 9 B	✓	✓	✓	✓
NS3 MILANO 10 / NS3B MILANO 10 B	✓	✓	✓	✓
NS4 MILANO 11 / NS4B MILANO 11 B	✓	✓	✓	✓
NS9 MILANO 12 / NS9B MILANO 12 B	✓	✓	✓	✓

RC2 STANDARD EQUIPMENT**

- GLAZED DOOR LEAF
- THERMO PRIME, THERMO PREMIUM – 4 SIDES REBATED
- OPTIMA – 3 SIDES REBATED
- THERMO PRIME – ALUTHERM DOOR FRAME
- THERMO PREMIUM – DUOTHERM DOOR FRAME
- OPTIMA – PERFOTHERM DOOR FRAME
- T. PRIME, T. PREMIUM – HINGES ADJUSTABLE IN THREE PLANES WITH CAPS MATCHING FITTING'S COLOUR
- OPTIMA – HINGES ADJUSTABLE IN TWO PLANES WITH CAPS MATCHING FITTING'S COLOUR
- APPLICATION ON DOOR PLANE
- DOUBLE-SIDED DESIGN
- THERMO PRIME, THERMO PREMIUM – WARM THRESHOLD WITH SUBTHRESHOLD EXTENSION, h=35 mm
- OPTIMA – ALUMINIUM THRESHOLD
- FITTINGS SET
- T. PRIME – LONG ESCUTCHEONS: PRAGA OR SPLIT; BERGEN
- T. PREMIUM – LONG ESCUTCHEONS: PRAGA OR BERGEN
- OPTIMA – LONG ESCUTCHEONS: PRAGA OR BERGEN
- THERMO PRIME – CLASS 5 LOCK CYLINDER, 5 POINT HOOK MORTISE LOCK OR 3 POINT AUTOMATIC MORTISE LOCK
- THERMO PREMIUM, OPTIMA – CLASS 5 LOCK CYLINDER, KEYED ALIKE SYSTEM, BOLT LOCK

EXTRA CHARGES

POWDER COATING, GALA COLOUR RANGE POWDER COATING, GALACTICA / GALA OPEN COLOUR RANGE POWDER COATING, INTERGALACTICA COLOUR RANGE TWO-COLOUR DOOR, GALA COLOUR RANGE			✓
			✓
			✓
CUSTOM HEIGHT, INCREMENTS EVERY 50 mm, AVAILABLE COLOURS: FRP, FDE, FDW, FDT, FKG, FKF, FSB, ONLY WITH ALUTHERM DOOR FRAME		2150 mm, 2200 mm 2250 mm, 2300 mm 2350 mm, 2400 mm	
ALUTHERM 75 DOOR FRAME ALUTHERM 60 DOOR FRAME		THERMO PREMIUM, THERMO PRIME – INTEGRATED CLOSER	
THERMO PREMIUM – MORTISE LOCK 3-POINT 2-HOOK / AUTOMATIC		1800 mm 1700 mm	
THERMO PREMIUM – AUXILIARY LOCK FOR MORTISE LOCK 2-HOOK		1500 mm 1000 mm	
TWO-COLOUR DOOR, TERRA PALETTE		1800 mm 1700 mm	
CLASS 6 LOCK CYLINDERS, KEYED ALIKE SYSTEM		1500 mm 1000 mm	
THERMO PREMIUM, OPTIMA – UPPER ESCUTCHEON PROTECTION		1700 mm 1500 mm	
KNOB-HANDLE		DOOR SHORTENING NS1, NS2, NS3, NS9 (10, 20, 30, 40 mm) NS4 (10, 20, 30, 40, 60, 80, 100 mm)	
REED SWITCH		DOOR TO SIZE, INCREMENTS EVERY 10 mm, Hmax=2400 mm, Smax=1130 mm ONLY WITH ALUTHERM DOOR FRAME	
SIZE 100E			
ELECTRIC STRIKE WITH DAY / NIGHT FEATURE		tedee PRO SET	

GLASS

FIXED GLAZED SIDE PANELS: PAGES 94-95, FULL EQUIPMENT LIST: PAGES 98-105

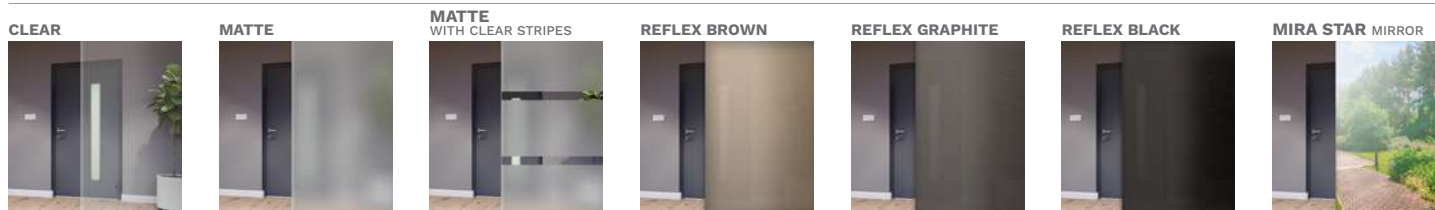

DOOR COLOURS

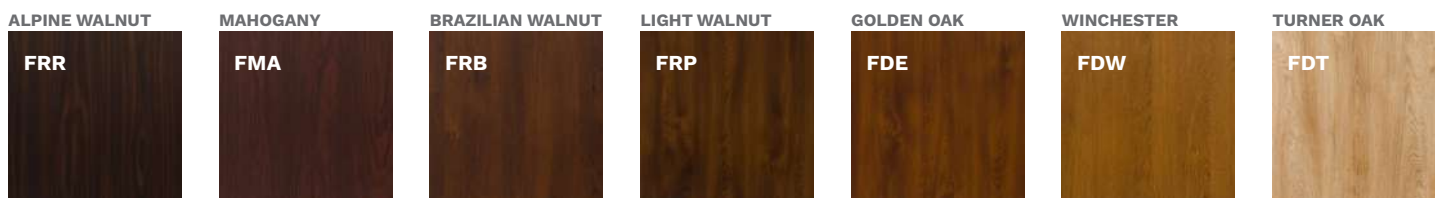



NS3 MILANO 10



NS4 MILANO 11



NS9 MILANO 12



NS1B MILANO 8 B



NS1B MILANO 8 B
INTERNAL SIDE



NS2 MILANO 9

standard FITTINGS

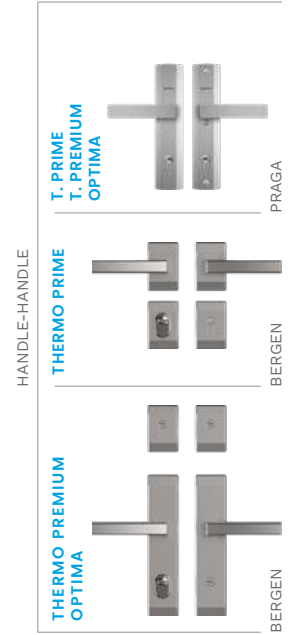

extra charge FITTINGS

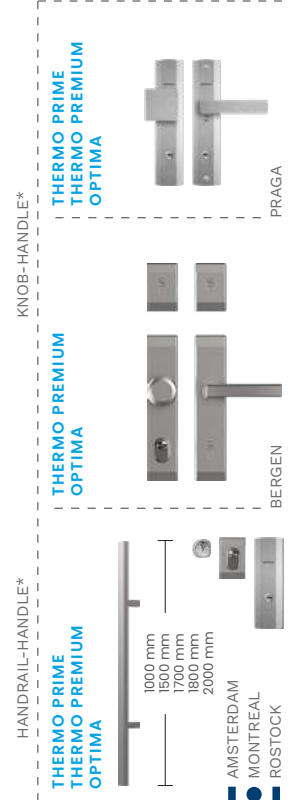

INSERTS AND APPLICATION COLOURS



DOOR COLOURS



* EXTRA CHARGE

** FOR GLAZED DOORS RC2N



NS5B HANOVER 5 B



NS6 HANOVER 6

DOOR SIZE (THERMO PRIME, THERMO PREMIUM)	-	80	90N	90E	100E*
DOOR HEIGHT (DUOTHERM, PERFOTHERM / ALUTHERM)	2076 mm / 2087-2400 mm				
DOOR SIZE (OPTIMA)	80N	80	90N	90E	100E*

MODEL	OPTIMA 60	THERMO PREMIUM 60	THERMO PREMIUM 75	THERMO PRIME 75
NS5 HANOVER 5 / NS5B HANOVER 5 B	✓	✓	✓	✓
NS6 HANOVER 6 / NS6B HANOVER 6 B	✓	✓	✓	✓
NS7 INNSBRUCK / NS7B INNSBRUCK B	✓	✓	✓	✓

RC2 STANDARD EQUIPMENT**

<ul style="list-style-type: none"> GLAZED DOOR LEAF THERMO PRIME, THERMO PREMIUM – 4 SIDES REBATED OPTIMA – 3 SIDES REBATED THERMO PRIME – ALUTHERM DOOR FRAME THERMO PREMIUM – DUOTHERM DOOR FRAME OPTIMA – PERFOTHERM DOOR FRAME T. PRIME, T. PREMIUM – HINGES ADJUSTABLE IN THREE PLANES WITH CAPS MATCHING FITTING'S COLOUR OPTIMA – HINGES ADJUSTABLE IN TWO PLANES WITH CAPS MATCHING FITTING'S COLOUR APPLICATION ON DOOR PLANE DOUBLE-SIDED DESIGN 	<ul style="list-style-type: none"> THERMO PRIME, THERMO PREMIUM – WARM THRESHOLD WITH SUBTHRESHOLD EXTENSION, h=35 mm OPTIMA – ALUMINIUM THRESHOLD FITTINGS SET T. PRIME – LONG ESCUTCHEONS: PRAGA OR SPLIT: BERGEN T. PREMIUM – LONG ESCUTCHEONS: PRAGA OR BERGEN OPTIMA – LONG ESCUTCHEONS: PRAGA OR BERGEN THERMO PRIME – CLASS 5 LOCK CYLINDER, 5 POINT HOOK MORTISE LOCK OR 3 POINT AUTOMATIC MORTISE LOCK THERMO PREMIUM, OPTIMA – CLASS 5 LOCK CYLINDER, KEYED ALIKE SYSTEM, BOLT LOCK
------------------------------------------------------------------------------------------------------------------------------------------------------------------------------------------------------------------------------------------------------------------------------------------------------------------------------------------------------------------------------------------------------------------------------------------------------------------------------------------------------------------------------------------------------------	-----------------------------------------------------------------------------------------------------------------------------------------------------------------------------------------------------------------------------------------------------------------------------------------------------------------------------------------------------------------------------------------------------------------------------------------------------------------------------------------------------------------------------------------------------------------------------

EXTRA CHARGES

POWDER COATING, GALA COLOUR RANGE		✓
POWDER COATING, GALACTICA / GALA OPEN COLOUR RANGE		✓
POWDER COATING, INTERGALACTICA COLOUR RANGE		✓
TWO-COLOUR DOOR, GALA COLOUR RANGE		✓
CUSTOM HEIGHT, INCREMENTS EVERY 50 mm, AVAILABLE COLOURS: FRP, FDE, FDW, FDT, FKG, FKF, FSB, ONLY WITH ALUTHERM DOOR FRAME	2150 mm, 2250 mm, 2350 mm,	2200 mm, 2300 mm, 2400 mm
ALUTHERM 75 DOOR FRAME		1800 mm
ALUTHERM 60 DOOR FRAME	AMSTERDAM / MONTREAL HANDRAIL	1700 mm
THERMO PREMIUM – MORTISE LOCK 3-POINT 2-HOOK / AUTOMATIC	ELECTRIC STRIKE RECOMMENDED	1500 mm 1000 mm
THERMO PREMIUM – AUXILIARY LOCK FOR MORTISE LOCK 2-HOOK	AMSTERDAM / MONTREAL HANDRAIL WITH PUSHBUTTON, WITH DOOR LEAF ADJUSTMENT AND ELECTRIC STRIKE	1800 mm 1700 mm 1500 mm 1000 mm
TWO-COLOUR DOOR, TERRA PALETTE	AMSTERDAM HANDRAIL WITH WIRELESS PUSHBUTTON	1700 mm
CLASS 6 LOCK CYLINDERS, KEYED ALIKE SYSTEM	ELECTRIC STRIKE NECESSARY	1500 mm
THERMO PREMIUM, OPTIMA – UPPER ESCUTCHEON PROTECTION	THERMO PREMIUM, THERMO PRIME – ROSTOCK HANDRAIL	2000 mm
KNOB-HANDLE	DOOR SHORTENING NS6 (10, 20, 30, 40 mm) NS5 (10, 20, 30, 40, 60, 80, 100 mm)	
REED SWITCH	HANOVER – DOOR TO SIZE, INCREMENTS EVERY 10 mm, Hmax=2400 mm, Smax=1130 mm ONLY WITH ALUTHERM DOOR FRAME	
THERMO PREMIUM, THERMO PRIME – INTEGRATED CLOSER	tedee PRO SET	
ELECTRIC STRIKE WITH DAY / NIGHT FEATURE	THERMO PREMIUM – RING ESCUTCHEON FOR DOOR WITH HANDRAIL AND MORTISE LOCK	no extra charge

GLASS

FIXED GLAZED SIDE PANELS: PAGES 94–95, FULL EQUIPMENT LIST: PAGES 98–105

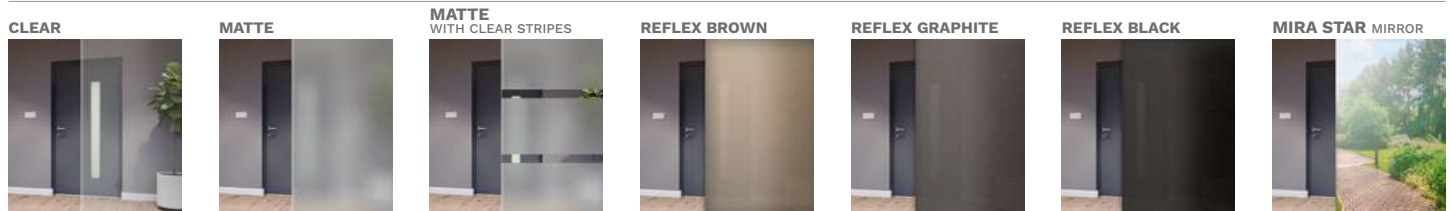

DOOR COLOURS

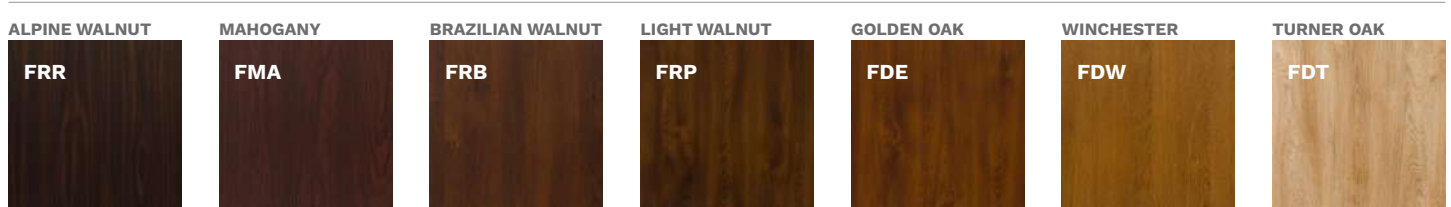



NS7 INNSBRUCK



**NS7 INNSBRUCK
INTERNAL SIDE**



NS5 HANOVER 5



NS5B HANOVER 5 B



**NS5B HANOVER 5 B
INTERNAL SIDE**



NS7 INNSBRUCK

standard FITTINGS

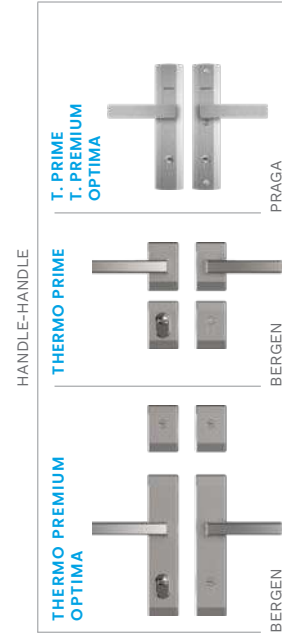

extra charge FITTINGS

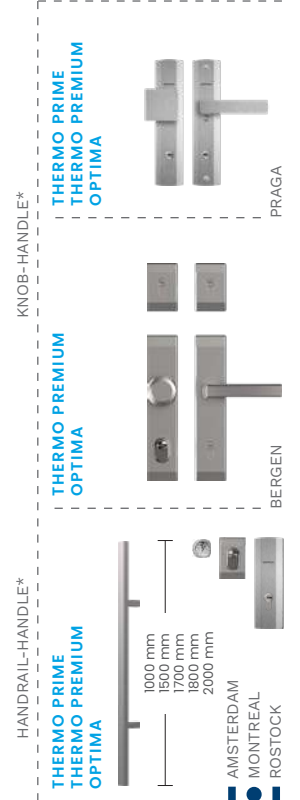

INSERTS AND APPLICATION COLOURS



DOOR COLOURS



* EXTRA CHARGE

** FOR GLAZED DOORS RC2N



W00 PLAIN



W00 PLAIN

DOOR SIZE (THERMO PRIME, THERMO PREMIUM)	-	80	90N	90E	100E*
DOOR HEIGHT (DUOTHERM, PERFOTHERM / ALUTHERM)	2076 mm / 2087-2400 mm				
DOOR SIZE (OPTIMA)	80N	80	90N	90E	100E*

MODEL	OPTIMA 50	OPTIMA 60	THERMO PREMIUM 60	THERMO PREMIUM 75	THERMO PRIME 75
W00 PLAIN	✓	✓	✓	✓	✓

RC2 STANDARD EQUIPMENT**

<ul style="list-style-type: none"> SOLID DOOR LEAF 	<ul style="list-style-type: none"> THERMO PRIME, THERMO PREMIUM – WARM THRESHOLD WITH SUBTHRESHOLD EXTENSION, h=35 mm OPTIMA – ALUMINIUM THRESHOLD
<ul style="list-style-type: none"> THERMO PRIME, THERMO PREMIUM – 4 SIDES REBATED OPTIMA – 3 SIDES REBATED 	<ul style="list-style-type: none"> FITTINGS SET
<ul style="list-style-type: none"> THERMO PRIME – ALUTHERM DOOR FRAME THERMO PREMIUM – DUOTHERM DOOR FRAME OPTIMA – PERFOTHERM DOOR FRAME OPTIMA 50 – FB OR FN DOOR FRAME 	<ul style="list-style-type: none"> T. PRIME – LONG ESCUTCHEONS: PRAGA OR SPLIT: BERGEN T. PREMIUM – LONG ESCUTCHEONS: PRAGA OR BERGEN OPTIMA – LONG ESCUTCHEONS: PRAGA OR BERGEN
<ul style="list-style-type: none"> T. PRIME, T. PREMIUM – HINGES ADJUSTABLE IN THREE PLANES WITH CAPS MATCHING FITTING'S COLOUR OPTIMA – HINGES ADJUSTABLE IN TWO PLANES WITH CAPS MATCHING FITTING'S COLOUR 	<ul style="list-style-type: none"> THERMO PRIME – CLASS 5 LOCK CYLINDER, 5 POINT HOOK MORTISE LOCK OR 3 POINT AUTOMATIC MORTISE LOCK THERMO PREMIUM, OPTIMA – CLASS 5 LOCK CYLINDER, KEYED ALIKE SYSTEM, BOLT LOCK

EXTRA CHARGES

POWDER COATING, GALA COLOUR RANGE		✓
POWDER COATING, GALACTICA / GALA OPEN COLOUR RANGE		✓
POWDER COATING, INTERGALACTICA COLOUR RANGE		✓
TWO-COLOUR DOOR, GALA COLOUR RANGE		✓
CUSTOM HEIGHT, INCREMENTS EVERY 50 mm, AVAILABLE COLOURS: FRP, FDE, FDW, FDT, FKG, FKF, FSB, ONLY WITH ALUTHERM DOOR FRAME	2150 mm, 2200 mm 2250 mm, 2300 mm 2350 mm, 2400 mm	
ALUTHERM 75 DOOR FRAME		1800 mm
ALUTHERM 60 DOOR FRAME	AMSTERDAM / MONTREAL HANDRAIL	1700 mm
PERFOTHERM 50 DOOR FRAME	ELECTRIC STRIKE RECOMMENDED	1500 mm
THERMO PREMIUM – MORTISE LOCK 3-POINT 2-HOOK / AUTOMATIC		1000 mm
THERMO PREMIUM – AUXILIARY LOCK FOR MORTISE LOCK 2-HOOK	AMSTERDAM / MONTREAL HANDRAIL WITH PUSHBUTTON, WITH DOOR LEAF ADJUSTMENT AND ELECTRIC STRIKE	1800 mm 1700 mm 1500 mm 1000 mm
TWO-COLOUR DOOR, TERRA PALETTE		
RC3 PACKAGE	AMSTERDAM HANDRAIL WITH WIRELESS PUSHBUTTON	1700 mm
CLASS 6 LOCK CYLINDERS, KEYED ALIKE SYSTEM	ELECTRIC STRIKE NECESSARY	1500 mm
THERMO PREMIUM, OPTIMA – UPPER ESCUTCHEON PROTECTION	THERMO PREMIUM, THERMO PRIME – ROSTOCK HANDRAIL	2000 mm
KNOB-HANDLE	DOOR SHORTENING (10, 20, 30, 40, 60, 80, 100 mm)	
REED SWITCH	DOOR TO SIZE, INCREMENTS EVERY 10 mm, Hmax=2400 mm, Smax=1130 mm ONLY WITH ALUTHERM DOOR FRAME	
SIZE 100E	tedee PRO SET	
THERMO PREMIUM, THERMO PRIME – INTEGRATED CLOSER	THERMO PREMIUM – RING ESCUTCHEON FOR DOOR WITH HANDRAIL AND MORTISE LOCK	no extra charge
ELECTRIC STRIKE WITH DAY / NIGHT FEATURE		

FIXED GLAZED SIDE PANELS: PAGES 94–95, FULL EQUIPMENT LIST: PAGES 98–105

DOOR COLOURS

ALPINE WALNUT	MAHOGANY	BRAZILIAN WALNUT	LIGHT WALNUT	GOLDEN OAK	WINCHESTER	TURNER OAK
FRR	FMA	FRB	FRP	FDE	FDW	FDT



WOO PLAIN



WOO PLAIN
INTERNAL SIDE



WOO PLAIN



WOO PLAIN



WOO PLAIN
INTERNAL SIDE

standard FITTINGS

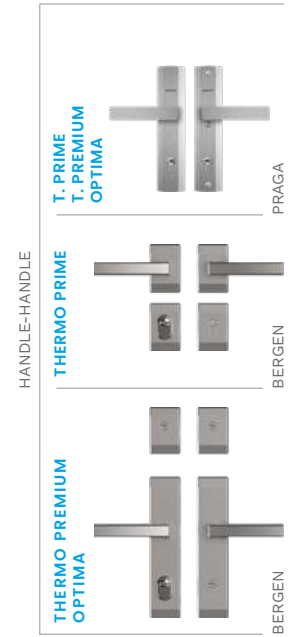

extra charge FITTINGS

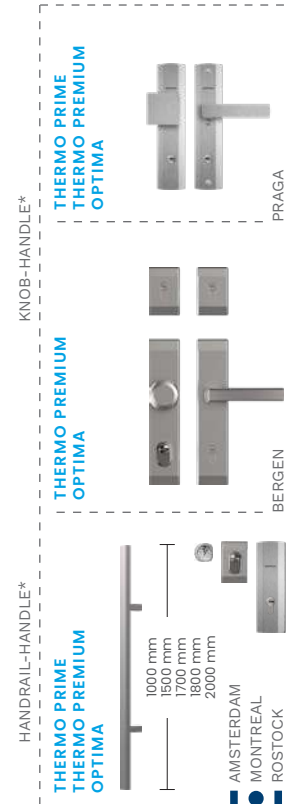

FITTINGS COLOURS

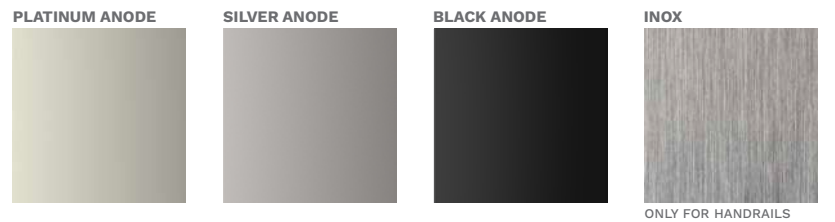

LIGHT WENGE



WHITE



STEEL GRAY



ANTHRACITE

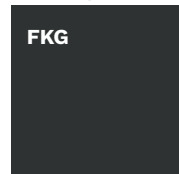

DARK ANTHRACITE

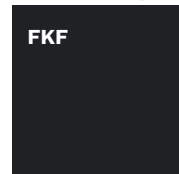

BLACK

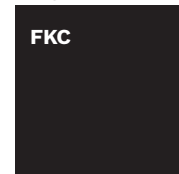

TWO-COLOUR DOOR*

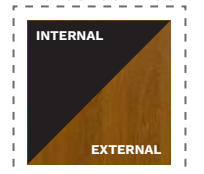

* EXTRA CHARGE

** FOR GLAZED DOORS RC2N



SNU MILANO 4



SNU MILANO 4
INTERNAL SIDE

DOOR SIZE	80N	80	90N	90E	100E*
DOOR HEIGHT (PERFOTHERM / ALUTHERM)	2076 mm / 2087 mm				

MODEL	OPTIMA 50	OPTIMA 60
SNU MILANO 4	-	✓
SNUA MILANO 4 A	-	✓
SNUB MILANO 4 B	-	✓

RC2 STANDARD EQUIPMENT**

- GLAZED DOOR LEAF
- 3 SIDES REBATED
- PERFOTHERM 60 DOOR FRAME
- HINGES ADJUSTABLE IN TWO PLANES WITH CAPS MATCHING FITTING'S COLOUR
- DEBOSSED OR DEBOSSED WITH INSERT
- DOUBLE-SIDED DESIGN
- ALUMINIUM THRESHOLD
- FITTINGS SET
- LONG ESCUTCHEONS: PRAGA OR BERGEN
- CLASS 5 LOCK CYLINDER, KEYED ALIKE SYSTEM, BOLT LOCK

EXTRA CHARGES

POWDER COATING, GALA COLOUR RANGE	✓
POWDER COATING, GALACTICA / GALA OPEN COLOUR RANGE	✓
POWDER COATING, INTERGALACTICA COLOUR RANGE	✓
TWO-COLOUR DOOR, GALA COLOUR RANGE	✓
ALUTHERM 60 DOOR FRAME	1800 mm
THERMO PRIME DOOR CONSTRUCTION***	AMSTERDAM / MONTREAL HANDRAIL ELECTRIC STRIKE RECOMMENDED 1700 mm
THERMO PREMIUM 75 DOOR CONSTRUCTION***	1500 mm
THERMO PREMIUM 60 DOOR CONSTRUCTION***	1000 mm
TWO-COLOUR DOOR, TERRA PALETTE	AMSTERDAM / MONTREAL HANDRAIL WITH PUSHBUTTON, WITH DOOR LEAF ADJUSTMENT AND ELECTRIC STRIKE 1800 mm
CLASS 6 LOCK CYLINDERS, KEYED ALIKE SYSTEM	1700 mm
UPPER ESCUTCHEON PROTECTION	1500 mm
KNOB-HANDLE	1000 mm
REED SWITCH	AMSTERDAM HANDRAIL WITH WIRELESS PUSHBUTTON ELECTRIC STRIKE NECESSARY 1700 mm
SIZE 100E	1500 mm
ELECTRIC STRIKE WITH DAY / NIGHT FEATURE	DOOR SHORTENING (10, 20, 30, 40, 60, 80, 100 mm) tedee PRO SET

FIXED GLAZED SIDE PANELS: PAGES 94-95, FULL EQUIPMENT LIST: PAGES 98-105

GLASS

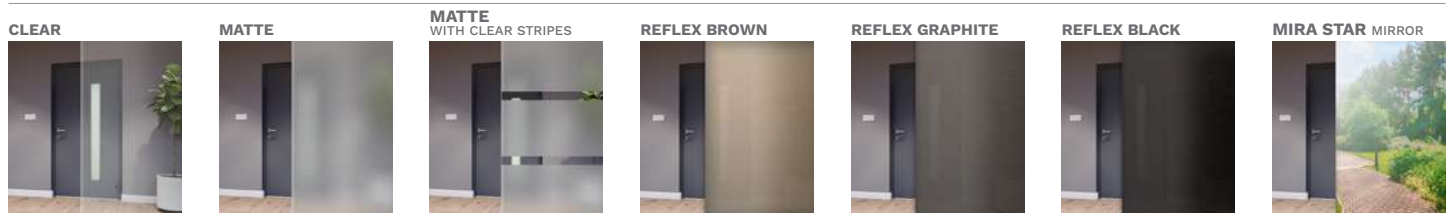

DOOR COLOURS

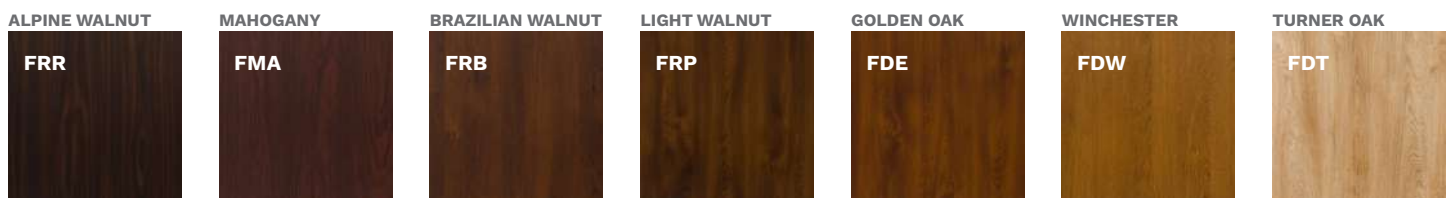



SNUA MILANO 4 A



SNUA MILANO 4 A
INTERNAL SIDE



SNUB MILANO 4 B



SNUB MILANO 4 B
INTERNAL SIDE

standard FITTINGS

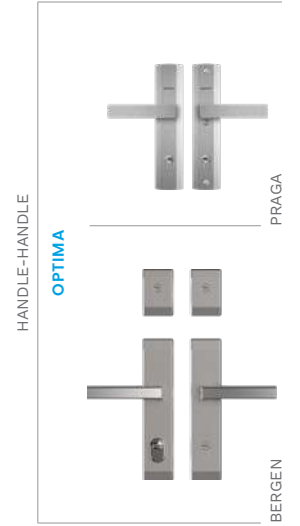

extra charge FITTINGS

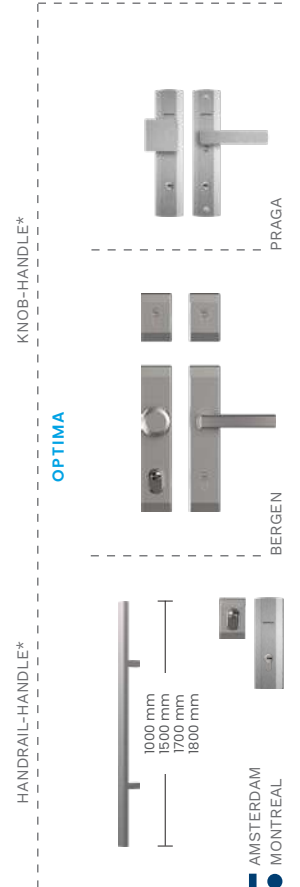

INSERTS AND APPLICATION COLOURS

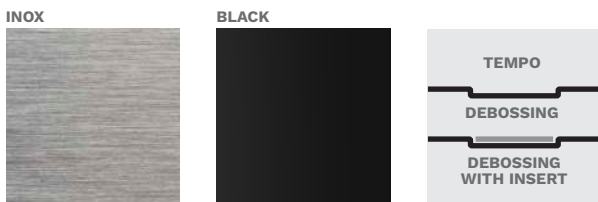

FITTINGS COLOURS

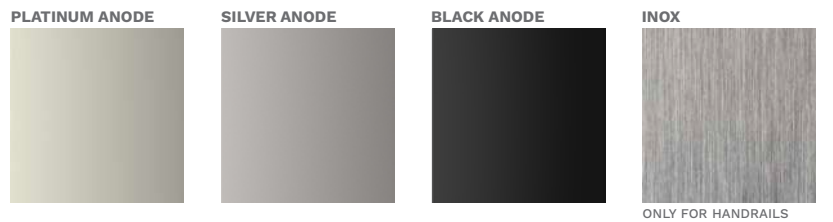

DOOR COLOURS



* EXTRA CHARGE

** FOR GLAZED DOORS RC2N

*** SPECIAL ORDER



NTI TURYN 1



NTI TURYN 1
INTERNAL SIDE

DOOR SIZE	80N	80	90N	90E	100E*
DOOR HEIGHT (PERFOTHERM / ALUTHERM)	2076 mm / 2087 mm				

MODEL	OPTIMA 50	OPTIMA 60
NTI TURYN 1	-	✓
NTIB TURYN 1 B	-	✓
NT2 TURYN 2	-	✓
NT2B TURYN 2 B	-	✓

RC2 STANDARD EQUIPMENT**

- GLAZED DOOR LEAF
- 3 SIDES REBATED
- PERFOTHERM 60 DOOR FRAME
- HINGES ADJUSTABLE IN TWO PLANES WITH CAPS MATCHING FITTING'S COLOUR
- APPLICATION ON DOOR PLANE
- DOUBLE-SIDED DESIGN
- ALUMINIUM THRESHOLD
- FITTINGS SET
- LONG ESCUTCHEONS: PRAGA OR BERGEN
- CLASS 5 LOCK CYLINDER, KEYED ALIKE SYSTEM, BOLT LOCK

EXTRA CHARGES

	POWDER COATING, GALA COLOUR RANGE	✓
	POWDER COATING, GALACTICA / GALA OPEN COLOUR RANGE	✓
	POWDER COATING, INTERGALACTICA COLOUR RANGE	✓
	TWO-COLOUR DOOR, GALA COLOUR RANGE	✓
ALUTHERM 60 DOOR FRAME		1800 mm
THERMO PRIME DOOR CONSTRUCTION***	AMSTERDAM / MONTREAL HANDRAIL	1700 mm
THERMO PREMIUM 75 DOOR CONSTRUCTION***	ELECTRIC STRIKE RECOMMENDED	1500 mm
THERMO PREMIUM 60 DOOR CONSTRUCTION***		1000 mm
TWO-COLOUR DOOR, TERRA PALETTE		1800 mm
CLASS 6 LOCK CYLINDERS, KEYED ALIKE SYSTEM	AMSTERDAM / MONTREAL HANDRAIL WITH PUSHBUTTON, WITH DOOR LEAF ADJUSTMENT AND ELECTRIC STRIKE	1700 mm
UPPER ESCUTCHEON PROTECTION		1500 mm
KNOB-HANDLE		1000 mm
REED SWITCH	AMSTERDAM HANDRAIL WITH WIRELESS PUSHBUTTON	1700 mm
SIZE 100E	ELECTRIC STRIKE NECESSARY	1500 mm
ELECTRIC STRIKE WITH DAY / NIGHT FEATURE	tedee PRO SET	

FIXED GLAZED SIDE PANELS: PAGES 94-95, FULL EQUIPMENT LIST: PAGES 98-105

GLASS

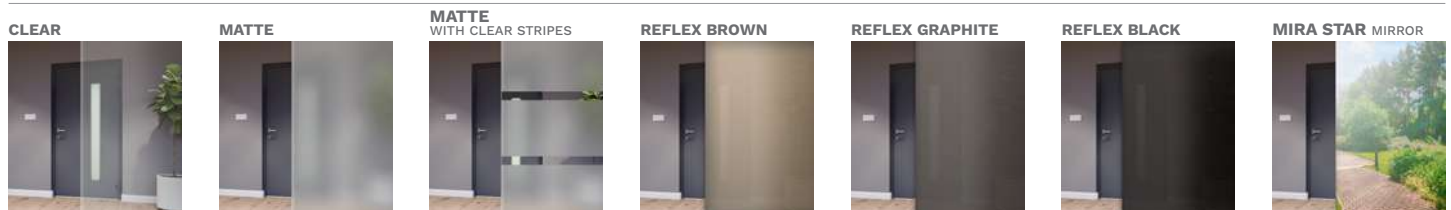

DOOR COLOURS

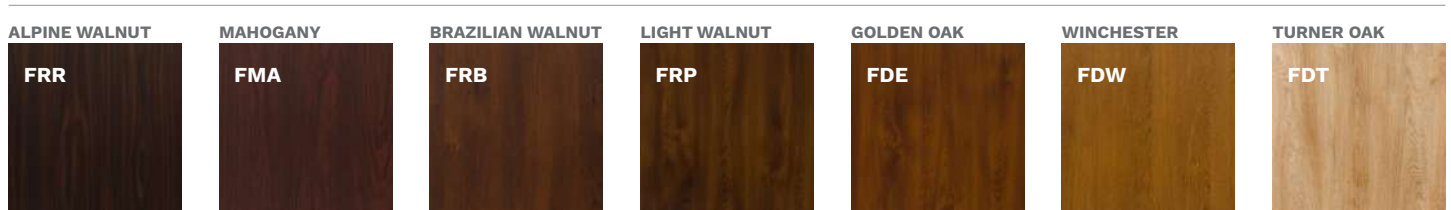



NT1B TURYN 1 B



NT2 TURYN 2



NT2 TURYN 2
INTERNAL SIDE



NT2B TURYN 2 B



NT2B TURYN 2 B
INTERNAL SIDE

standard FITTINGS

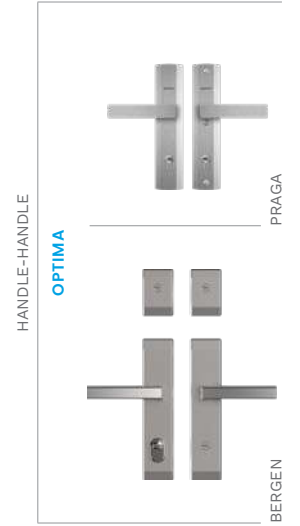

extra charge FITTINGS

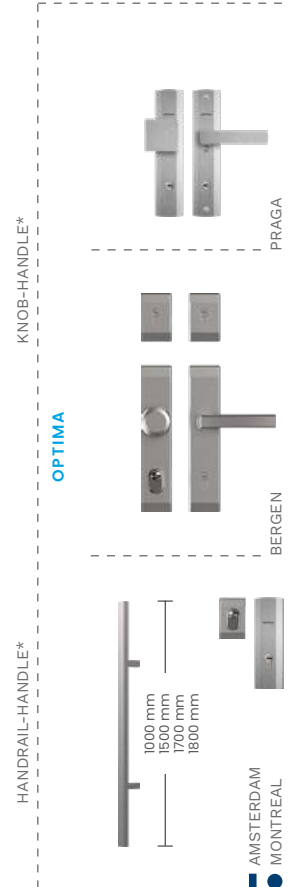

INSERTS AND APPLICATION COLOURS



DOOR COLOURS



* EXTRA CHARGE

** FOR GLAZED DOORS RC2N

*** SPECIAL ORDER



SOJ BERGAMO 2



SOJ BERGAMO 2
INTERNAL SIDE

DOOR SIZE	80N	80	90N	90E	100E*
DOOR HEIGHT (PERFOTHERM / ALUTHERM)	2076 mm / 2087 mm				

MODEL	OPTIMA 50	OPTIMA 60
SOJ BERGAMO 2	-	✓
SJ9 NICEA 9	-	✓
SBE BERLIN	-	✓

RC2 STANDARD EQUIPMENT**

- GLAZED DOOR LEAF
- 3 SIDES REBATED
- PERFOTHERM 60 DOOR FRAME
- HINGES ADJUSTABLE IN TWO PLANES WITH CAPS MATCHING FITTING'S COLOUR
- APPLICATION ON DOOR PLANE
- DOUBLE-SIDED DESIGN
- ALUMINIUM THRESHOLD
- FITTINGS SET
- LONG ESCUTCHEONS: PRAGA OR BERGEN
- CLASS 5 LOCK CYLINDER, KEYED ALIKE SYSTEM, BOLT LOCK

EXTRA CHARGES

	POWDER COATING, GALA COLOUR RANGE	✓
	POWDER COATING, GALACTICA / GALA OPEN COLOUR RANGE	✓
	POWDER COATING, INTERGALACTICA COLOUR RANGE	✓
	TWO-COLOUR DOOR, GALA COLOUR RANGE	✓
ALUTHERM 60 DOOR FRAME	1800 mm	
THERMO PRIME DOOR CONSTRUCTION***	AMSTERDAM / MONTREAL HANDRAIL ELECTRIC STRIKE RECOMMENDED	1700 mm 1500 mm
THERMO PREMIUM 75 DOOR CONSTRUCTION***		1000 mm
THERMO PREMIUM 60 DOOR CONSTRUCTION***		1800 mm
TWO-COLOUR DOOR, TERRA PALETTE	AMSTERDAM / MONTREAL HANDRAIL WITH PUSHBUTTON, WITH DOOR LEAF ADJUSTMENT AND ELECTRIC STRIKE	1700 mm 1500 mm 1000 mm
CLASS 6 LOCK CYLINDERS, KEYED ALIKE SYSTEM		1000 mm
UPPER ESCUTCHEON PROTECTION		1700 mm
KNOB-HANDLE	AMSTERDAM HANDRAIL WITH WIRELESS PUSHBUTTON ELECTRIC STRIKE NECESSARY	1500 mm
REED SWITCH		
SIZE 100E	DOOR SHORTENING SOJ (10, 20, 30, 40 mm) SJ9, SBE (10, 20, 30, 40, 60, 80, 100 mm)	
ELECTRIC STRIKE WITH DAY / NIGHT FEATURE	tedee PRO SET	

FIXED GLAZED SIDE PANELS: PAGES 94-95, FULL EQUIPMENT LIST: PAGES 98-105

GLASS

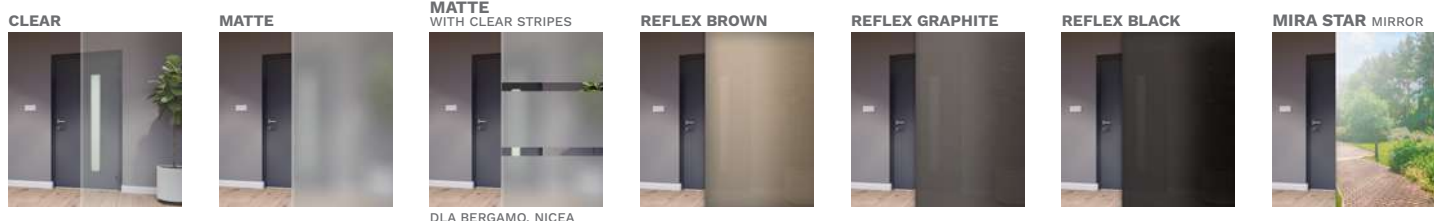

DLA BERGAMO, NICEA

DOOR COLOURS

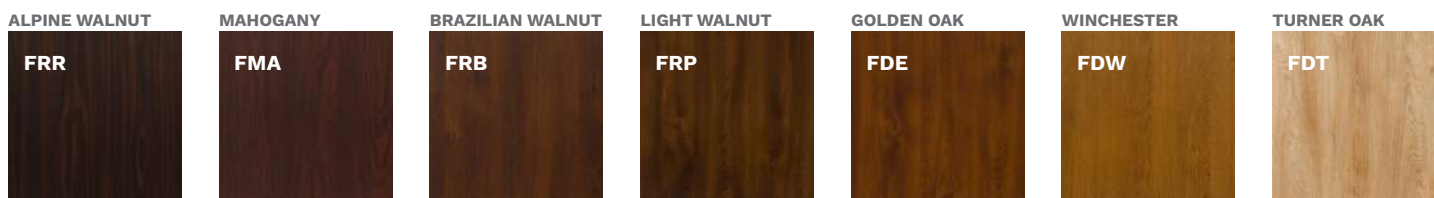



SJ9 NICEA 9



SJ9 NICEA 9
INTERNAL SIDE



SBE BERLIN



SBE BERLIN
INTERNAL SIDE

standard FITTINGS

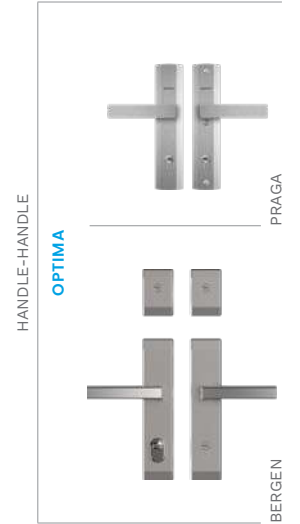

extra charge FITTINGS

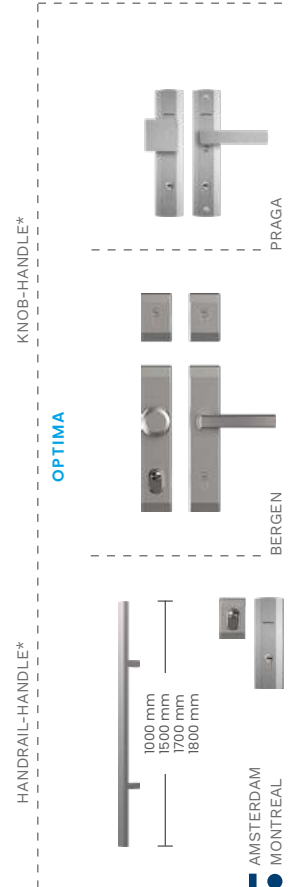

INSERTS AND APPLICATION COLOURS

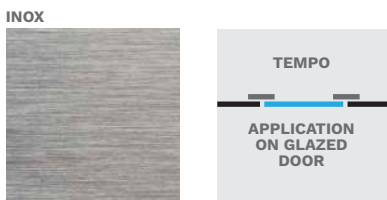

FITTINGS COLOURS

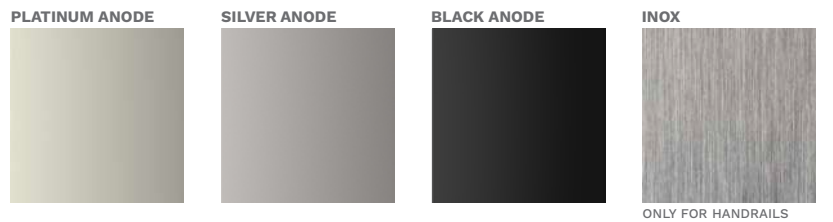

DOOR COLOURS



* EXTRA CHARGE

** FOR GLAZED DOORS RC2N

*** SPECIAL ORDER



ST4 UPPSALA 1
DEBOSSING



ST4A UPPSALA 1 A
DEBOSSING WITH INSERTS

DOOR SIZE	80N	80	90N	90E	100E*
DOOR HEIGHT (FB, PERFOTHERM / ALUTHERM)	2076 mm / 2087 mm				

MODEL	OPTIMA 50	OPTIMA 60
ST4 UPPSALA 1	✓	✓
ST4A UPPSALA 1 A	✓	✓

RC2 STANDARD EQUIPMENT**

- SOLID DOOR LEAF
- 3 SIDES REBATED
- OPTIMA 60 – PERFOTHERM 60 DOOR FRAME
- OPTIMA 50 – FB OR FN STEEL FRAME
- HINGES ADJUSTABLE IN TWO PLANES WITH CAPS MATCHING FITTING'S COLOUR
- DEBOSSING OR DEBOSSING WITH INSERT
- DOUBLE-SIDED DESIGN
- ALUMINIUM THRESHOLD
- FITTINGS SET
- LONG ESCUTCHEONS: PRAGA OR BERGEN
- CLASS 5 LOCK CYLINDER, KEYED ALIKE SYSTEM, BOLT LOCK

EXTRA CHARGES

N POWDER COATING, GALA COLOUR RANGE	✓
POWDER COATING, GALACTICA / GALA OPEN COLOUR RANGE	✓
POWDER COATING, INTERGALACTICA COLOUR RANGE	✓
TWO-COLOUR DOOR, GALA COLOUR RANGE	✓
OPTIMA 60 – ALUTHERM 60 DOOR FRAME	1800 mm
OPTIMA 50 – PERFOTHERM 50 DOOR FRAME	1700 mm
THERMO PRIME DOOR CONSTRUCTION***	AMSTERDAM / MONTREAL HANDRAIL ELECTRIC STRIKE RECOMMENDED
THERMO PREMIUM 75 DOOR CONSTRUCTION***	1500 mm
THERMO PREMIUM 60 DOOR CONSTRUCTION***	1000 mm
TWO-COLOUR DOOR, TERRA PALETTE	1800 mm
RC3 PACKAGE	AMSTERDAM / MONTREAL HANDRAIL WITH PUSHBUTTON, WITH DOOR LEAF ADJUSTMENT AND ELECTRIC STRIKE
CLASS 6 LOCK CYLINDERS, KEYED ALIKE SYSTEM	1500 mm
UPPER ESCUTCHEON PROTECTION	1000 mm
KNOB-HANDLE	AMSTERDAM HANDRAIL
REED SWITCH	WITH WIRELESS PUSHBUTTON ELECTRIC STRIKE NECESSARY
SIZE 100E	1700 mm
ELECTRIC STRIKE WITH DAY / NIGHT FEATURE	1500 mm
	tedee PRO SET

FIXED GLAZED SIDE PANELS: PAGES 94–95, FULL EQUIPMENT LIST: PAGES 98–105

DOOR COLOURS

ALPINE WALNUT	MAHOGANY	BRAZILIAN WALNUT	LIGHT WALNUT	GOLDEN OAK	WINCHESTER	TURNER OAK
FRR	FMA	FRB	FRP	FDE	FDW	FDT



ST4 UPPSALA 1



ST4 UPPSALA 1



ST4 UPPSALA 1
INTERNAL SIDE



ST4A UPPSALA 1 A
INTERNAL SIDE



ST4 UPPSALA 1



ST4 UPPSALA 1

standard FITTINGS

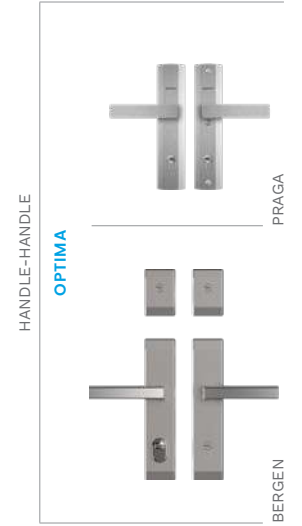

extra charge FITTINGS

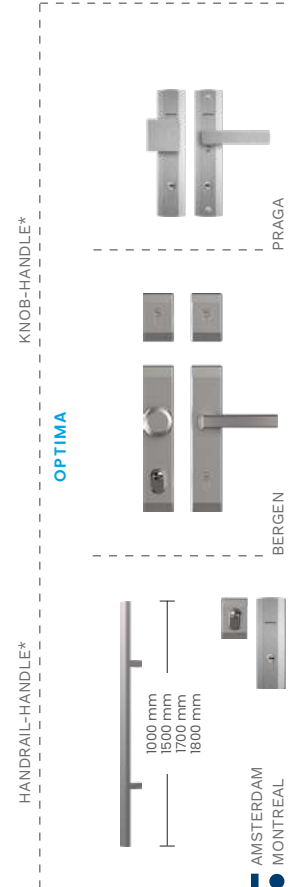

INSERT COLOUR

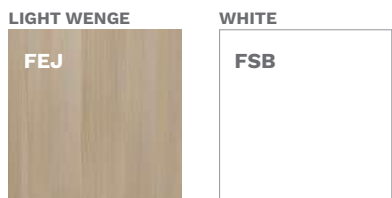
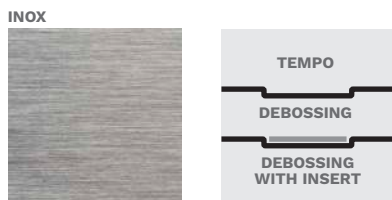

FITTINGS COLOURS

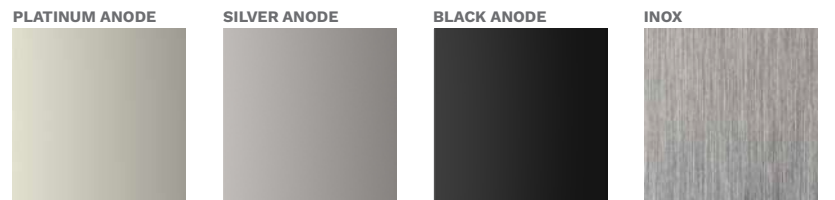

ONLY FOR HANDRAILS



* EXTRA CHARGE

** FOR GLAZED DOORS RC2N

*** SPECIAL ORDER



TML TOKIO 1
DEBOSSING



TMLA TOKIO 1 A
DEBOSSING WITH INSERTS

DOOR SIZE	80N	80	90N	90E	100E*
DOOR HEIGHT (FB, PERFOTHERM / ALUTHERM)	2076 mm / 2087 mm				

MODEL	OPTIMA 50	OPTIMA 60
TML TOKIO 1	✓	✓
TMLA TOKIO 1 A	✓	✓
TMM TOKIO 2	✓	✓
TMMA TOKIO 2 A	✓	✓

RC2 STANDARD EQUIPMENT**

- SOLID DOOR LEAF
- 3 SIDES REBATED
- OPTIMA 60 – PERFOTHERM 60 DOOR FRAME
- OPTIMA 50 – FB OR FN STEEL FRAME
- HINGES ADJUSTABLE IN TWO PLANES WITH CAPS MATCHING FITTING'S COLOUR
- DEBOSSING OR DEBOSSING WITH INSERT
- DOUBLE-SIDED DESIGN
- ALUMINIUM THRESHOLD
- FITTINGS SET
- LONG ESCUTCHEONS: PRAGA OR BERGEN
- CLASS 5 LOCK CYLINDER, KEYED ALIKE SYSTEM, BOLT LOCK

EXTRA CHARGES

	POWDER COATING, GALA COLOUR RANGE	✓
	POWDER COATING, GALACTICA / GALA OPEN COLOUR RANGE	✓
	POWDER COATING, INTERGALACTICA COLOUR RANGE	✓
	TWO-COLOUR DOOR, GALA COLOUR RANGE	✓
OPTIMA 60 – ALUTHERM 60 DOOR FRAME		1800 mm
OPTIMA 50 – PERFOTHERM 50 DOOR FRAME		1700 mm
THERMO PRIME DOOR CONSTRUCTION***	AMSTERDAM / MONTREAL HANDRAIL ELECTRIC STRIKE RECOMMENDED	1500 mm
THERMO PREMIUM 75 DOOR CONSTRUCTION***		1000 mm
THERMO PREMIUM 60 DOOR CONSTRUCTION***		1800 mm
TWO-COLOUR DOOR, TERRA PALETTE		1700 mm
RC3 PACKAGE	AMSTERDAM / MONTREAL HANDRAIL WITH PUSHBUTTON, WITH DOOR LEAF ADJUSTMENT AND ELECTRIC STRIKE	1500 mm
CLASS 6 LOCK CYLINDERS, KEYED ALIKE SYSTEM		1000 mm
UPPER ESCUTCHEON PROTECTION		1700 mm
KNOB-HANDLE	AMSTERDAM HANDRAIL WITH WIRELESS PUSHBUTTON	1500 mm
REED SWITCH	ELECTRIC STRIKE NECESSARY	
SIZE 100E		
ELECTRIC STRIKE WITH DAY / NIGHT FEATURE	bedee PRO SET	

FIXED GLAZED SIDE PANELS: PAGES 94–95, FULL EQUIPMENT LIST: PAGES 98–105

DOOR COLOURS

ALPINE WALNUT

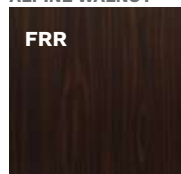

MAHOGANY

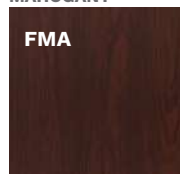

BRAZILIAN WALNUT

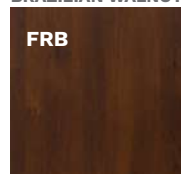

LIGHT WALNUT

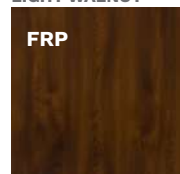

GOLDEN OAK

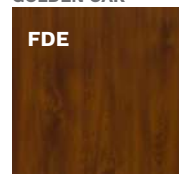

WINCHESTER

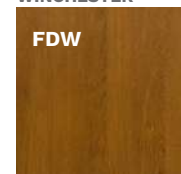

TURNER OAK





TMM TOKIO 2



**TMM TOKIO 2
INTERNAL SIDE**



TMM TOKIO 2



TMMA TOKIO 2 A



**TMMA TOKIO 2 A
INTERNAL SIDE**



TML TOKIO 1

standard FITTINGS

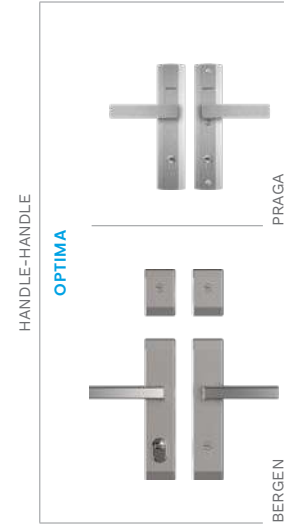

extra charge FITTINGS

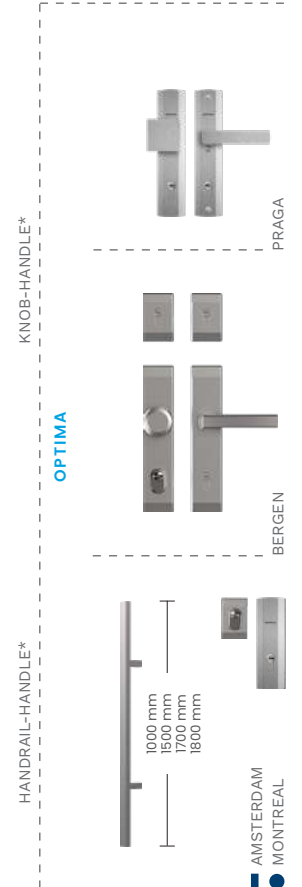

INSERT COLOUR

INOX

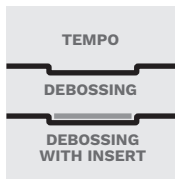

FITTINGS COLOURS

PLATINUM ANODE



SILVER ANODE



BLACK ANODE



INOX



ONLY FOR HANDRAILS

LIGHT WENGE



WHITE



STEEL GRAY



ANTHRACITE

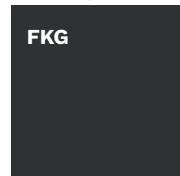

DARK ANTHRACITE

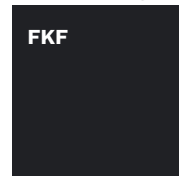

BLACK

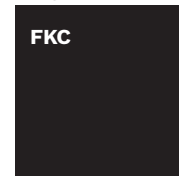

TWO-COLOUR DOOR*



* EXTRA CHARGE

** FOR GLAZED DOORS RC2N

*** SPECIAL ORDER



ST8 RYGA



ST9 LUND

DOOR SIZE	80N	80	90N	90E	100E*
DOOR HEIGHT (FB, PERFOTHERM / ALUTHERM)	2076 mm / 2087 mm				

MODEL	OPTIMA 50	OPTIMA 60
ST8 RYGA	✓	✓
ST9 LUND	✓	✓
WBA ASPEN 1	✓	✓
TN7 ASPEN 2	✓	✓
TN7B ASPEN 2 B	✓	✓

RC2 STANDARD EQUIPMENT**

- SOLID DOOR LEAF
- 3 SIDES REBATED
- OPTIMA 60 – PERFOTHERM 60 DOOR FRAME
- OPTIMA 50 – FB OR FN STEEL FRAME
- HINGES ADJUSTABLE IN TWO PLANES WITH CAPS MATCHING FITTING'S COLOUR
- DEBOSSING OR DEBOSSING WITH INSERT
- DOUBLE-SIDED DESIGN
- ALUMINIUM THRESHOLD
- FITTINGS SET
- LONG ESCUTCHEONS: PRAGA OR BERGEN
- CLASS 5 LOCK CYLINDER, KEYED ALIKE SYSTEM, BOLT LOCK

EXTRA CHARGES

POWDER COATING, GALA COLOUR RANGE	✓
POWDER COATING, GALACTICA / GALA OPEN COLOUR RANGE	✓
POWDER COATING, INTERGALACTICA COLOUR RANGE	✓
TWO-COLOUR DOOR, GALA COLOUR RANGE	✓
OPTIMA 60 – ALUTHERM 60 DOOR FRAME	1800 mm
OPTIMA 50 – PERFOTHERM 50 DOOR FRAME	1700 mm
THERMO PRIME DOOR CONSTRUCTION***	AMSTERDAM / MONTREAL HANDRAIL ELECTRIC STRIKE RECOMMENDED 1500 mm
THERMO PREMIUM 75 DOOR CONSTRUCTION***	1000 mm
THERMO PREMIUM 60 DOOR CONSTRUCTION***	1800 mm
TWO-COLOUR DOOR, TERRA PALETTE	AMSTERDAM / MONTREAL HANDRAIL WITH PUSHBUTTON, WITH DOOR LEAF ADJUSTMENT AND ELECTRIC STRIKE 1700 mm
RCS PACKAGE	1500 mm
CLASS 6 LOCK CYLINDERS, KEYED ALIKE SYSTEM	1000 mm
UPPER ESCUTCHEON PROTECTION	AMSTERDAM HANDRAIL WITH WIRELESS PUSHBUTTON ELECTRIC STRIKE NECESSARY 1700 mm
KNOB-HANDLE	1500 mm
REED SWITCH	
SIZE 100E	DOOR SHORTENING WBA, TN7, TN7B (10, 20, 30, 40, 60, 80, 100 mm)
ELECTRIC STRIKE WITH DAY / NIGHT FEATURE	tedee PRO SET

FIXED GLAZED SIDE PANELS: PAGES 94–95, FULL EQUIPMENT LIST: PAGES 98–105

DOOR COLOURS

ALPINE WALNUT	MAHOGANY	BRAZILIAN WALNUT	LIGHT WALNUT	GOLDEN OAK	WINCHESTER	TURNER OAK
FRR	FMA	FRB	FRP	FDE	FDW	FDT



WBA ASPEN 1



TN7 ASPEN 2



**TN7 ASPEN 2
INTERNAL SIDE**



**ST9 LUND
INTERNAL SIDE**



TN7B ASPEN 2 B



**TN7B ASPEN 2 B
INTERNAL SIDE**

standard FITTINGS

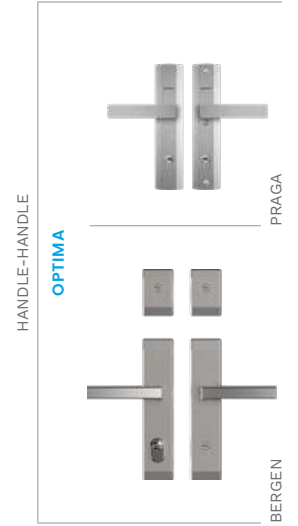

extra charge FITTINGS

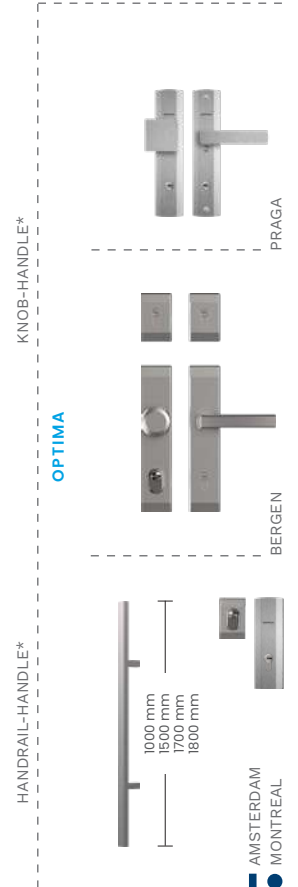

QUADRO INSERT COLOURS



ONLY FOR ASPEN 2 B

FITTINGS COLOURS

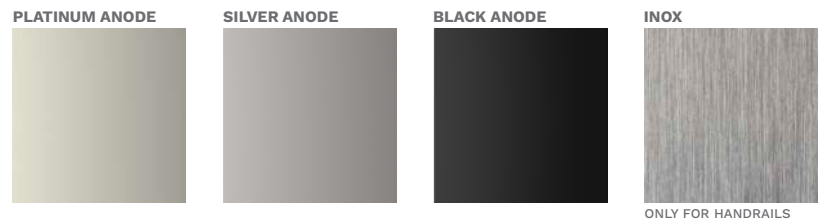

ONLY FOR HANDRAILS

DOOR COLOURS



* EXTRA CHARGE

** FOR GLAZED DOORS RC2N



SR3 TROMSO



SR4 TROMSO 1

DOOR SIZE	80N	80	90N	90E	100E*
DOOR HEIGHT (FB, PERFOTHERM / ALUTHERM)	2076 mm / 2087 mm				

MODEL	OPTIMA 50	OPTIMA 60
SR3 TROMSO	✓	✓
SR4 TROMSO 1	✓	✓
SR5 TROMSO 2	✓	✓

RC2 STANDARD EQUIPMENT**

- SOLID DOOR LEAF
- 3 SIDES REBATED
- OPTIMA 60 – PERFOTHERM 60 DOOR FRAME
- OPTIMA 50 – FB OR FN STEEL FRAME
- HINGES ADJUSTABLE IN TWO PLANES WITH CAPS MATCHING FITTING'S COLOUR
- DEBOSSING
- DOUBLE-SIDED DESIGN
- ALUMINIUM THRESHOLD
- FITTINGS SET
- LONG ESCUTCHEONS: PRAGA OR BERGEN
- CLASS 5 LOCK CYLINDER, KEYED ALIKE SYSTEM, BOLT LOCK

EXTRA CHARGES

N POWDER COATING, GALA COLOUR RANGE		✓
POWDER COATING, GALACTICA / GALA OPEN COLOUR RANGE		✓
POWDER COATING, INTERGALACTICA COLOUR RANGE		✓
TWO-COLOUR DOOR, GALA COLOUR RANGE		✓
OPTIMA 60 – ALUTHERM 60 DOOR FRAME		1800 mm
OPTIMA 50 – PERFOTHERM 50 DOOR FRAME	AMSTERDAM / MONTREAL HANDRAIL	1700 mm
THERMO PRIME DOOR CONSTRUCTION***	ELECTRIC STRIKE RECOMMENDED	1500 mm
THERMO PREMIUM 75 DOOR CONSTRUCTION***		1000 mm
THERMO PREMIUM 60 DOOR CONSTRUCTION***		1800 mm
TWO-COLOUR DOOR, TERRA PALETTE	AMSTERDAM / MONTREAL HANDRAIL WITH PUSHBUTTON,	1700 mm
RCS PACKAGE	WITH DOOR LEAF ADJUSTMENT AND ELECTRIC STRIKE	1500 mm
CLASS 6 LOCK CYLINDERS, KEYED ALIKE SYSTEM		1000 mm
UPPER ESCUTCHEON PROTECTION	AMSTERDAM HANDRAIL WITH WIRELESS PUSHBUTTON	1700 mm
KNOB-HANDLE	ELECTRIC STRIKE NECESSARY	1500 mm
REED SWITCH		
SIZE 100E	DOOR SHORTENING SR4 (10, 20, 30, 40 mm)	
ELECTRIC STRIKE WITH DAY / NIGHT FEATURE	tedee PRO SET	

FIXED GLAZED SIDE PANELS: PAGES 94–95, FULL EQUIPMENT LIST: PAGES 98–105

DOOR COLOURS

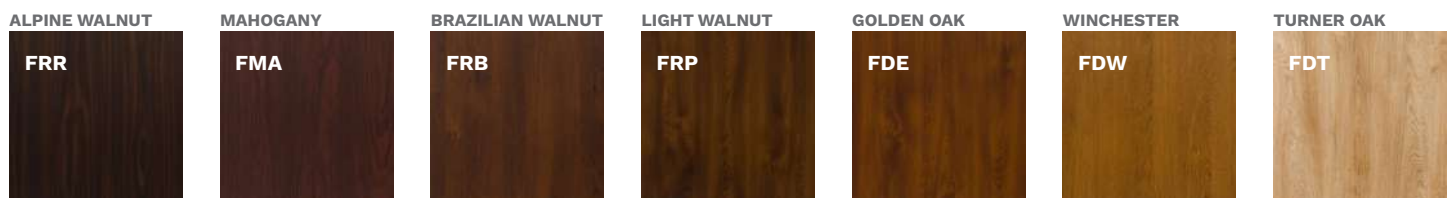



SR5 TROMSO 2



SR5 TROMSO 2



**SR5 TROMSO 2
INTERNAL SIDE**



**SR4 TROMSO 1
INTERNAL SIDE**



SR3 TROMSO



**SR3 TROMSO
INTERNAL SIDE**

standard FITTINGS

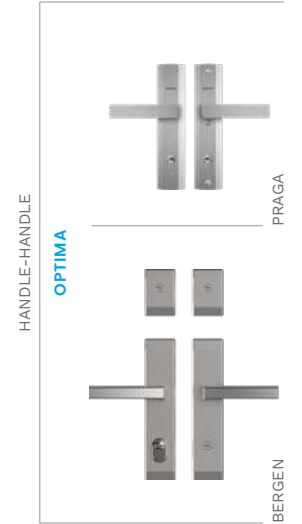

extra charge FITTINGS

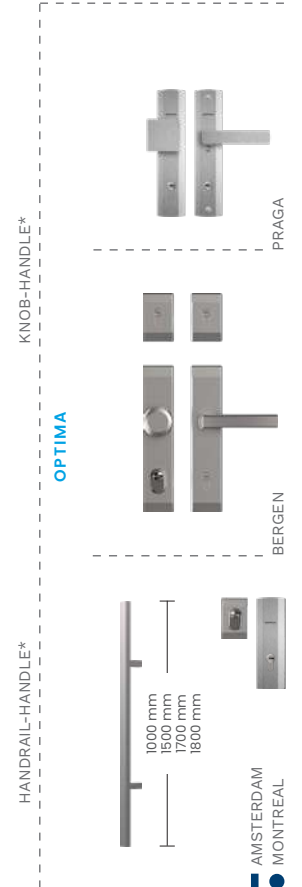

FITTINGS COLOURS

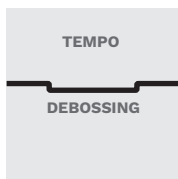

PLATINUM ANODE



SILVER ANODE



BLACK ANODE



INOX



ONLY FOR HANDRAILS

DOOR COLOURS

LIGHT WENGE



WHITE



STEEL GRAY

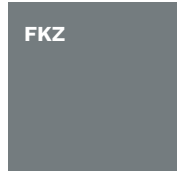

ANTHRACITE

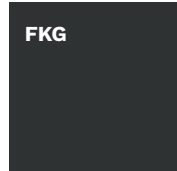

DARK ANTHRACITE

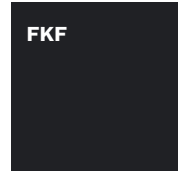

BLACK

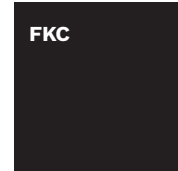

TWO-COLOUR DOOR*



* EXTRA CHARGE

** FOR GLAZED DOORS RC2N



W76 MODENA



W77 MODENA 2

DOOR SIZE	80	90N	90E
DOOR HEIGHT (FB, PERFOTHERM / ALUTHERM)	2076 mm / 2087 mm		

MODEL	OPTIMA 50	OPTIMA 60
W76 MODENA	-	✓
W77 MODENA 2	-	✓
W78 MODENA 3	-	✓
WDR RAVENA	✓	✓

RC2 STANDARD EQUIPMENT**

- GLAZED OR SOLID DOOR LEAF
- ALUMINIUM THRESHOLD
- 3 SIDES REBATED
- FITTINGS SET
- OPTIMA 60 – PERFOTHERM 60 DOOR FRAME
- LONG ESCUTCHEONS: PRAGA OR BERGEN
- OPTIMA 50 – FB OR FN STEEL DOOR FRAME
- CLASS 5 LOCK CYLINDER, KEYED ALIKE SYSTEM, BOLT LOCK
- HINGES ADJUSTABLE IN TWO PLANES WITH CAPS MATCHING FITTING'S COLOUR
- DOUBLE-SIDED DESIGN
- DEEP DEBOSSING

EXTRA CHARGES

POWDER COATING, GALA COLOUR RANGE	✓
POWDER COATING, GALACTICA / GALA OPEN COLOUR RANGE	✓
POWDER COATING, INTERGALACTICA COLOUR RANGE	✓
TWO-COLOUR DOOR, GALA COLOUR RANGE	✓
OPTIMA 60 – ALUTHERM 60 DOOR FRAME	RC3 PACKAGE (OPTIMA 60 WDR)
OPTIMA 50 – PERFOTHERM 50 DOOR FRAME	UPPER ESCUTCHEON PROTECTION
THERMO PRIME DOOR CONSTRUCTION***	KNOB-HANDLE
THERMO PREMIUM 75 DOOR CONSTRUCTION***	REED SWITCH
THERMO PREMIUM 60 DOOR CONSTRUCTION***	ELECTRIC STRIKE WITH DAY / NIGHT FEATURE
TWO-COLOUR DOOR, TERRA PALETTE	DOOR SHORTENING (10, 20, 30, 40, 60, 80, 100 mm)
CLASS 6 LOCK CYLINDERS, KEYED ALIKE SYSTEM	tedee PRO SET

FIXED GLAZED SIDE PANELS: PAGES 94-95, FULL EQUIPMENT LIST: PAGES 98-105

GLASS

MATTE



REFLEX BROWN



MIRA STAR MIRROR



DOOR COLOURS

ALPINE WALNUT

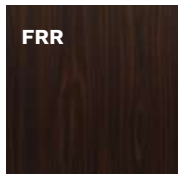

MAHOGANY

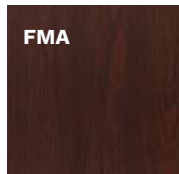

BRAZILIAN WALNUT

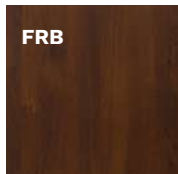

LIGHT WALNUT

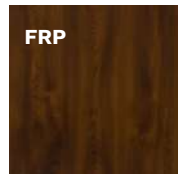

GOLDEN OAK



WINCHESTER

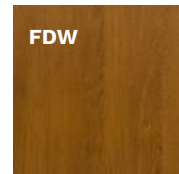

WHITE





W78 MODENA 3



WDR RAVENA



**WDR RAVENA
INTERNAL SIDE**



**W77 MODENA 2
INTERNAL SIDE**



W76 MODENA



W78 MODENA 3

standard FITTINGS

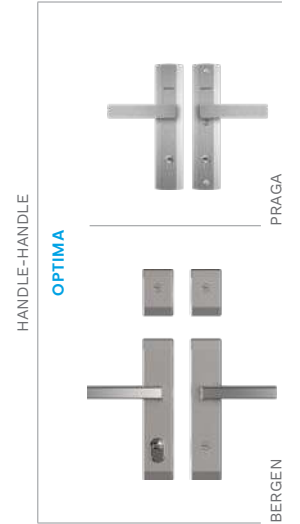

extra charge FITTINGS

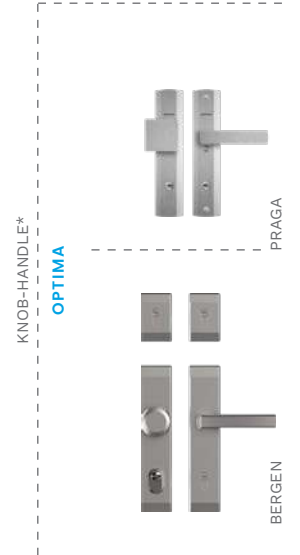

FITTINGS COLOURS

PLATINUM ANODE



SILVER ANODE



BLACK ANODE

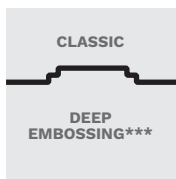
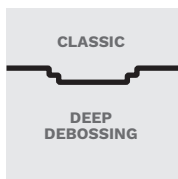
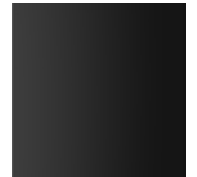

DOOR COLOURS

STEEL-GRAY



ANTHRACITE

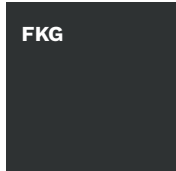

DARK ANTHRACITE

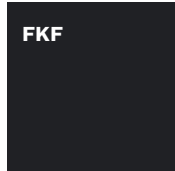

TWO-COLOUR DOOR*



* EXTRA CHARGE

** FOR GLAZED DOORS RC2N

*** SPECIAL ORDER



WJ1 NICEA 5



WJ1 NICEA 5
INTERNAL SIDE

DOOR SIZE	80	90N	90E
DOOR HEIGHT (FB, PERFOTHERM / ALUTHERM)	2076 mm / 2087 mm		

MODEL	OPTIMA 50	OPTIMA 60
WJ1 NICEA 5	-	✓
W23 OLYMPIA	-	✓

RC2 STANDARD EQUIPMENT**

- GLAZED DOOR LEAF
- 3 SIDES REBATED
- PERFOTHERM 60 DOOR FRAME
- HINGES ADJUSTABLE IN TWO PLANES WITH CAPS MATCHING FITTING'S COLOUR
- DOUBLE-SIDED DESIGN
- ALUMINIUM THRESHOLD
- FITTINGS SET
- LONG ESCUTCHEONS: PRAGA OR BERGEN
- CLASS 5 LOCK CYLINDER, KEYED ALIKE SYSTEM, BOLT LOCK
- DEEP DEBOSSING

EXTRA CHARGES

	POWDER COATING, GALA COLOUR RANGE	✓
	POWDER COATING, GALACTICA / GALA OPEN COLOUR RANGE	✓
	POWDER COATING, INTERGALACTICA COLOUR RANGE	✓
	TWO-COLOUR DOOR, GALA COLOUR RANGE	✓
OPTIMA 60 – ALUTHERM 60 DOOR FRAME	UPPER ESCUTCHEON PROTECTION	
THERMO PRIME DOOR CONSTRUCTION***	KNOB-HANDLE	
THERMO PREMIUM 75 DOOR CONSTRUCTION***	REED SWITCH	
THERMO PREMIUM 60 DOOR CONSTRUCTION***	SIZE 100E (W23)	
TWO-COLOUR DOOR, TERRA PALETTE	ELECTRIC STRIKE WITH DAY / NIGHT FEATURE	
CLASS 6 LOCK CYLINDERS, KEYED ALIKE SYSTEM	DOOR SHORTENING (10, 20, 30, 40, 60, 80, 100 mm)	
	tedee PRO SET	

FIXED GLAZED SIDE PANELS: PAGES 94–95, FULL EQUIPMENT LIST: PAGES 98–105

GLASS

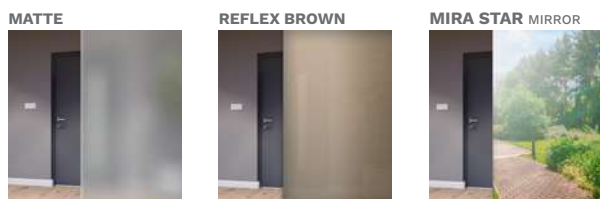

DOOR COLOURS

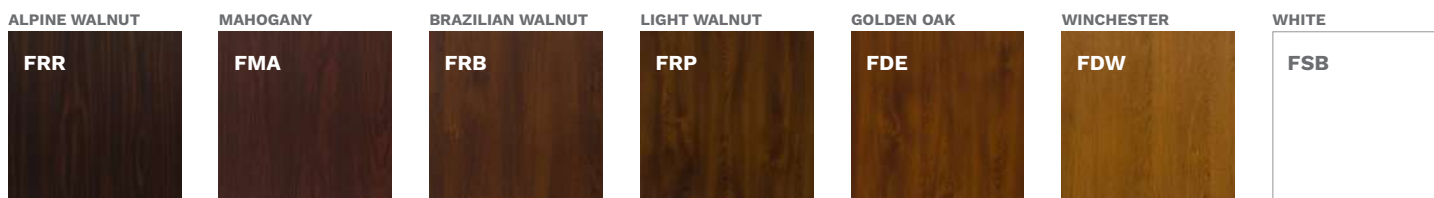



W23 OLYMPIA



**W23 OLYMPIA
INTERNAL SIDE**



W23 OLYMPIA



**W23 OLYMPIA
INTERNAL SIDE**

standard FITTINGS

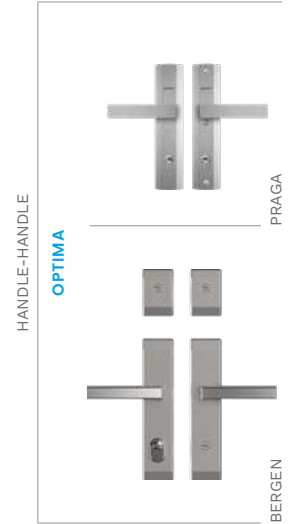

extra charge FITTINGS



FITTINGS COLOURS

PLATINUM ANODE



SILVER ANODE



BLACK ANODE

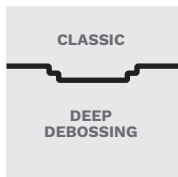
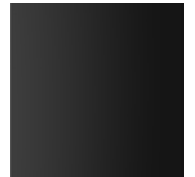

DOOR COLOURS

STEEL-GRAY



ANTHRACITE

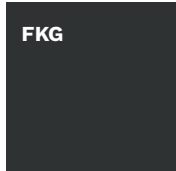

DARK ANTHRACITE

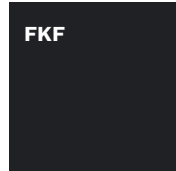

TWO-COLOUR DOOR*



* EXTRA CHARGE

** FOR GLAZED DOORS RC2N



W91 WERONA



W94 WERONA 1

DOOR SIZE	80	90N	90E
DOOR HEIGHT (FB, PERFOTHERM / ALUTHERM)	2076 mm / 2087 mm		

MODEL	OPTIMA 50	OPTIMA 60
W91 WERONA	✓	✓
W94 WERONA 1	-	✓
W93 WERONA 3	-	✓
W6A WERONA 4	-	✓
WQA WERONA 5	-	✓

RC2 STANDARD EQUIPMENT**

- GLAZED OR SOLID DOOR LEAF
- 3 SIDES REBATED
- OPTIMA 60 – PERFOTHERM 60 DOOR FRAME
- OPTIMA 50 – FB OR FN STEEL DOOR FRAME
- HINGES ADJUSTABLE IN TWO PLANES WITH CAPS MATCHING FITTING'S COLOUR
- DOUBLE-SIDED DESIGN
- ALUMINIUM THRESHOLD
- FITTINGS SET
- LONG ESCUTCHEONS: PRAGA OR BERGEN
- CLASS 5 LOCK CYLINDER, KEYED ALIKE SYSTEM, BOLT LOCK
- DEEP DEBOSSING

EXTRA CHARGES

POWDER COATING, GALA COLOUR RANGE	✓
POWDER COATING, GALACTICA / GALA OPEN COLOUR RANGE	✓
POWDER COATING, INTERGALACTICA COLOUR RANGE	✓
TWO-COLOUR DOOR, GALA COLOUR RANGE	✓
OPTIMA 60 – ALUTHERM 60 DOOR FRAME	CLASS 6 LOCK CYLINDERS, KEYED ALIKE SYSTEM
OPTIMA 50 – PERFOTHERM 50 DOOR FRAME	RC3 PACKAGE (OPTIMA 60 W91)
THERMO PRIME DOOR CONSTRUCTION***	UPPER ESCUTCHEON PROTECTION
THERMO PREMIUM 75 DOOR CONSTRUCTION***	KNOB-HANDLE
THERMO PREMIUM 60 DOOR CONSTRUCTION***	REED SWITCH
TWO-COLOUR DOOR, TERRA PALETTE	ELECTRIC STRIKE WITH DAY / NIGHT FEATURE
DEEP EMBOSING (W91)***	DOOR SHORTENING (10, 20, 30, 40, 60, 80, 100 mm)
	tedee PRO SET

FIXED GLAZED SIDE PANELS: PAGES 94-95, FULL EQUIPMENT LIST: PAGES 98-105

GLASS



DOOR COLOURS

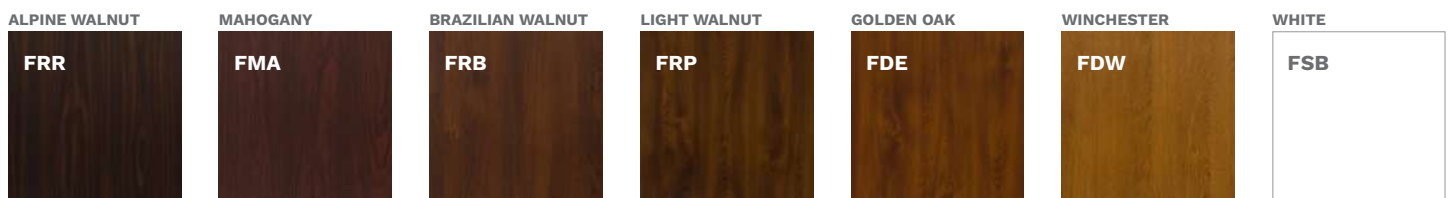



W93 WERONA 3



W6A WERONA 4



**W6A WERONA 4
INTERNAL SIDE**



WQA WERONA 5



**WQA WERONA 5
INTERNAL SIDE**



W91 WERONA

standard FITTINGS

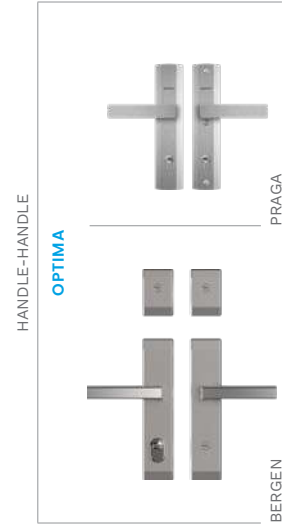

extra charge FITTINGS

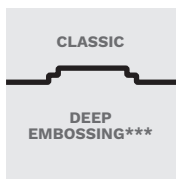
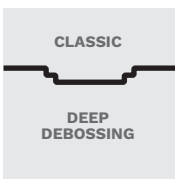
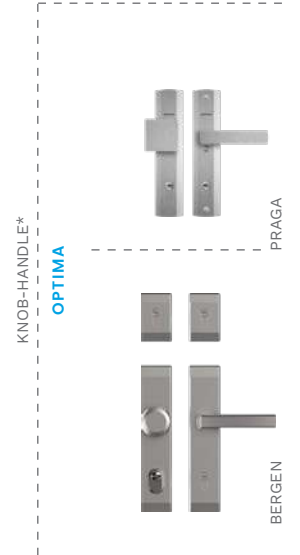

FITTINGS COLOURS

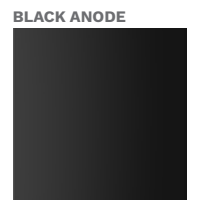

DOOR COLOURS

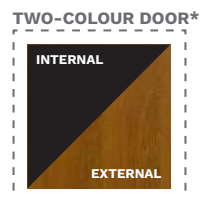
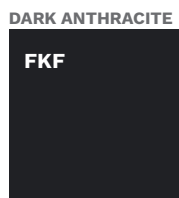

* EXTRA CHARGE

** FOR GLAZED DOORS RC2N

*** SPECIAL ORDER



W24 LIZBONA



W9N WENECJA

DOOR SIZE	80	90N	90E
DOOR HEIGHT (FB, PERFOTHERM / ALUTHERM)	2076 mm / 2087 mm		

MODEL	OPTIMA 50	OPTIMA 60
W24 LIZBONA	✓	✓
W9N WENECJA	✓	✓
W13 LONDYN	✓	✓
W5L LONDYN 1	-	✓

RC2 STANDARD EQUIPMENT**

- GLAZED OR SOLID DOOR LEAF
- 3 SIDES REBATED
- OPTIMA 60 – PERFOTHERM 60 DOOR FRAME
- OPTIMA 50 – FB OR FN STEEL DOOR FRAME
- HINGES ADJUSTABLE IN TWO PLANES WITH CAPS MATCHING FITTING'S COLOUR
- DOUBLE-SIDED DESIGN
- ALUMINIUM THRESHOLD
- FITTINGS SET
- LONG ESCUTCHEONS: PRAGA OR BERGEN
- CLASS 5 LOCK CYLINDER, KEYED ALIKE SYSTEM, BOLT LOCK
- DEEP DEBOSSING

EXTRA CHARGES

	POWDER COATING, GALA COLOUR RANGE	✓
	POWDER COATING, GALACTICA / GALA OPEN COLOUR RANGE	✓
	POWDER COATING, INTERGALACTICA COLOUR RANGE	✓
	TWO-COLOUR DOOR, GALA COLOUR RANGE	✓
OPTIMA 60 – ALUTHERM 60 DOOR FRAME	CLASS 6 LOCK CYLINDERS, KEYED ALIKE SYSTEM	
OPTIMA 50 – PERFOTHERM 50 DOOR FRAME	RC3 PACKAGE (OPTIMA 60 W24, W9N, W13)	
THERMO PRIME DOOR CONSTRUCTION***	UPPER ESCUTCHEON PROTECTION	
THERMO PREMIUM 75 DOOR CONSTRUCTION***	KNOB-HANDLE	
THERMO PREMIUM 60 DOOR CONSTRUCTION***	REED SWITCH	
TWO-COLOUR DOOR, TERRA PALETTE	ELECTRIC STRIKE WITH DAY / NIGHT FEATURE	
DEEP EMBOSING***	DOOR SHORTENING (10, 20, 30, 40, 60, 80, 100 mm)	
	tedee PRO SET	

FIXED GLAZED SIDE PANELS: PAGES 94–95, FULL EQUIPMENT LIST: PAGES 98–105

GLASS



DOOR COLOURS

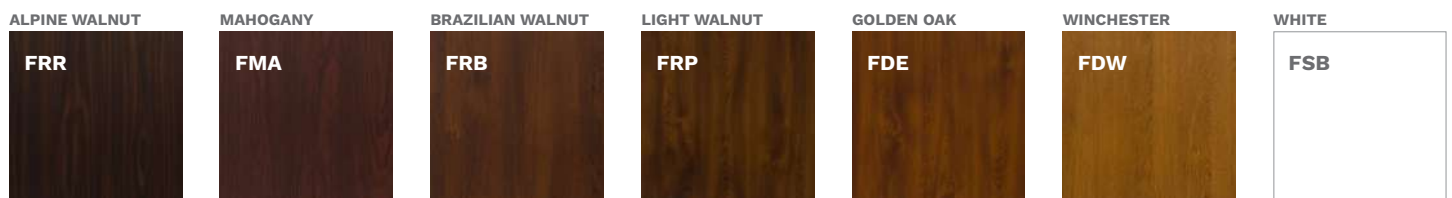



W13 LONDYN



**W13 LONDYN
INTERNAL SIDE**



W24 LIZBONA



**W9N WENECJA
INTERNAL SIDE**



W5L LONDYN 1



**W5L LONDYN 1
INTERNAL SIDE**

standard FITTINGS

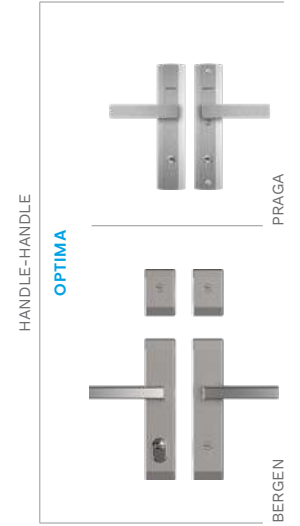

extra charge FITTINGS



FITTINGS COLOURS

PLATINUM ANODE



SILVER ANODE



BLACK ANODE

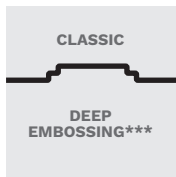
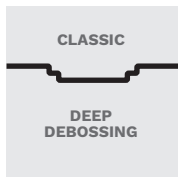
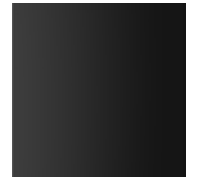

DOOR COLOURS

STEEL-GRAY



ANTHRACITE

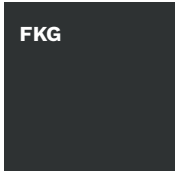

DARK ANTHRACITE

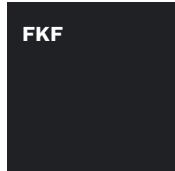

TWO-COLOUR DOOR*



* EXTRA CHARGE

** FOR GLAZED DOORS RC2N

*** SPECIAL ORDER



W54 BARCELONA



W53 BARCELONA 1

DOOR SIZE	80	90N	90E
DOOR HEIGHT (FB, PERFOTHERM / ALUTHERM)	2076 mm / 2087 mm		

MODEL	OPTIMA 50	OPTIMA 60
W54 BARCELONA	✓	✓
W53 BARCELONA 1	-	✓
G76 GENEWA 1	-	✓
G75 GENEWA 2	-	✓
D75 GENEWA 3	✓	✓

RC2 STANDARD EQUIPMENT**

- GLAZED OR SOLID DOOR LEAF
- ALUMINIUM THRESHOLD
- 3 SIDES REBATED
- FITTINGS SET
- OPTIMA 60 – PERFOTHERM 60 DOOR FRAME
- LONG ESCUTCHEONS: PRAGA OR BERGEN
- OPTIMA 50 – FB OR FN STEEL DOOR FRAME
- CLASS 5 LOCK CYLINDER, KEYED ALIKE SYSTEM, BOLT LOCK
- HINGES ADJUSTABLE IN TWO PLANES WITH CAPS MATCHING FITTING'S COLOUR
- DOUBLE-SIDED DESIGN
- DEEP DEBOSSING

EXTRA CHARGES

POWDER COATING, GALA COLOUR RANGE	✓
POWDER COATING, GALACTICA / GALA OPEN COLOUR RANGE	✓
POWDER COATING, INTERGALACTICA COLOUR RANGE	✓
TWO-COLOUR DOOR, GALA COLOUR RANGE	✓
OPTIMA 60 – ALUTHERM 60 DOOR FRAME	CLASS 6 LOCK CYLINDERS, KEYED ALIKE SYSTEM
OPTIMA 50 – PERFOTHERM 50 DOOR FRAME	RC3 PACKAGE (OPTIMA 60 W54, D75)
THERMO PRIME DOOR CONSTRUCTION***	UPPER ESCUTCHEON PROTECTION
THERMO PREMIUM 75 DOOR CONSTRUCTION***	KNOB-HANDLE
THERMO PREMIUM 60 DOOR CONSTRUCTION***	REED SWITCH
TWO-COLOUR DOOR, TERRA PALETTE	ELECTRIC STRIKE WITH DAY / NIGHT FEATURE
DEEP EMBOSING W54***	DOOR SHORTENING (10, 20, 30, 40, 60, 80, 100 mm)
	tedee PRO SET

FIXED GLAZED SIDE PANELS: PAGES 94-95, FULL EQUIPMENT LIST: PAGES 98-105

GLASS



DOOR COLOURS

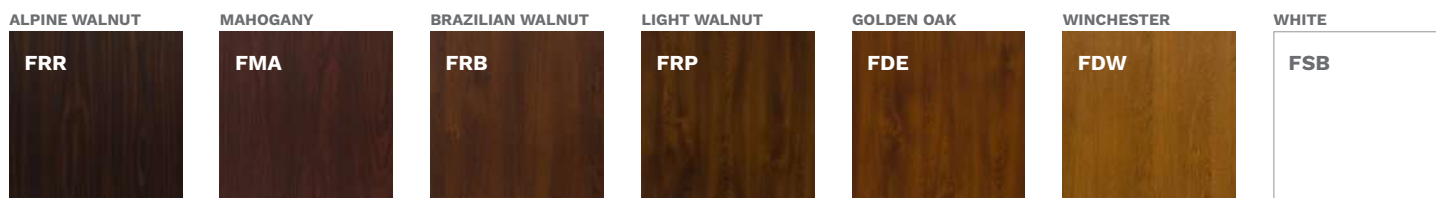



G76 GENEWA 1



**G76 GENEWA 1
INTERNAL SIDE**



G75 GENEWA 2



**W53 BARCELONA 1
INTERNAL SIDE**



D75 GENEWA 3



**D75 GENEWA 3
INTERNAL SIDE**

standard FITTINGS

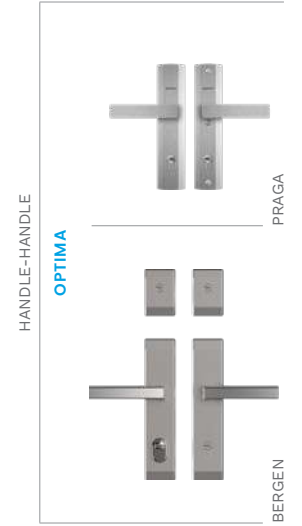

extra charge FITTINGS

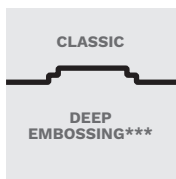
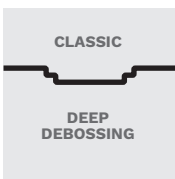

FITTINGS COLOURS

PLATINUM ANODE



SILVER ANODE



BLACK ANODE

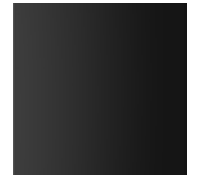

DOOR COLOURS

STEEL-GRAY



ANTHRACITE

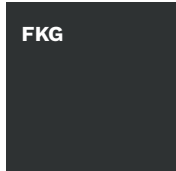

DARK ANTHRACITE

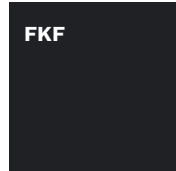

TWO-COLOUR DOOR*

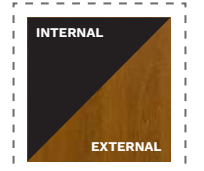

* EXTRA CHARGE

** FOR GLAZED DOORS RC2N

*** SPECIAL ORDER

OPTIMA 60 DUO have been designed for users looking for a custom-size door. A passive door leaf enables a broader passage. Passive door leaves are available both with and without glazing.

PARAMETERS

- ✓ DOOR FOR DETACHED HOUSES AS WELL AS FOR MULTI-FAMILY HOUSES
- ✓ STEEL DOOR LEAVES 60 mm THICK, FILLED WITH EXPANDED GRAPHITE POLYSTYRENE
- ✓ AVAILABLE WITH PERFOTHERM 60 DOOR FRAME AND ALUMINUM THRESHOLD
- ✓ ALUTHERM 60 ALUMINUM DOOR FRAME WITH AN EXTRA CHARGE
- ✓ PASSIVE DOOR LEAVES IN SOLID AND GLAZED DESIGN, IN SIZES 30, 40, 50 cm
- ✓ DOOR AVAILABLE IN 12 COLOURS

DOOR FRAME DIMENSIONS AND MOUNTING HOLES – SEE p. 110–111

PASSIVE DOORS*

The passive door leaf price includes price for treshold and door frame. Alutherm 60 aluminum door frame – EXTRA CHARGE.

NAME	SIZE
P00	30 40 50
PD4	40
GH1	40 50
GC2	40 50
GN5	30 40 50
GPD	30 40 50
DN3 / DN3B	30 40 50
DN6 / DN6B	30 40 50
DT8 / DT8B	50
DW9 / DW9B	50
DW8 / DW8B	50
DPE / DPEB	30 40 50
PD5	30 40 50
PD5A	30 40 50
PD5B	30 40 50
NMB	30 40 50
NMBA	30 40 50
NMBB	30 40 50
NMA	30 40 50
NMAA	30 40 50
NMAB	30 40 50

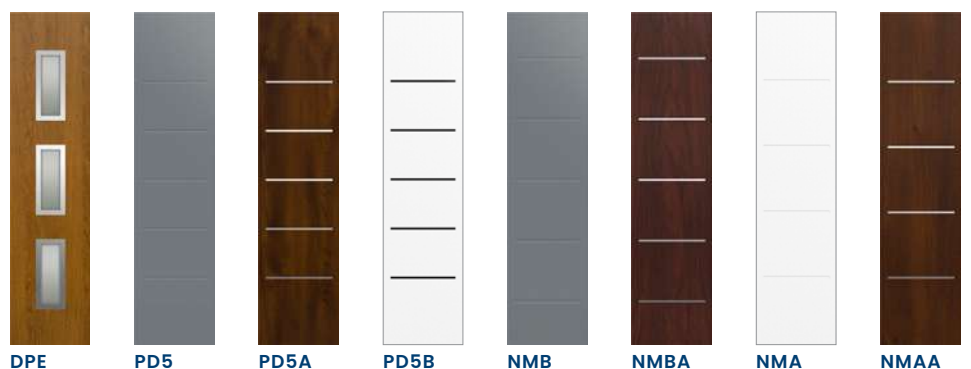
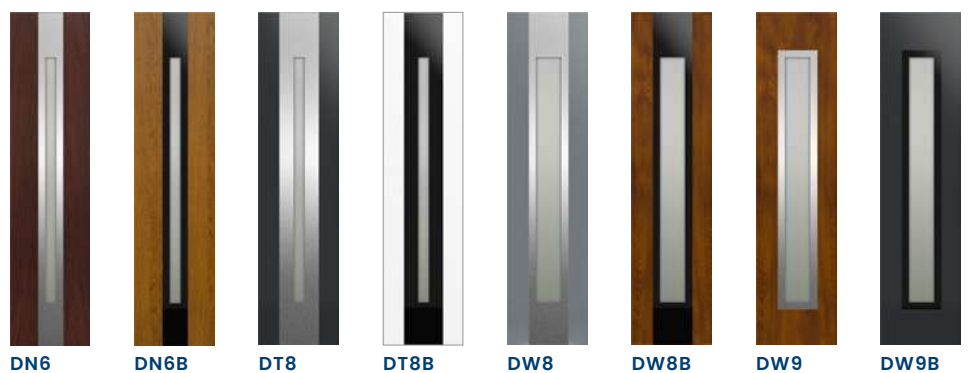

POWDER COATING*	
	OPTIMA DUO
GALA PALETTE	✓
GALACTICA PALETTE	✓
INTERGALACTICA PALETTE	✓
GALA OPEN PALETTE	✓



SOJ BERGAMO 2 + NMBA



NS5 HANOVER 5 + DW9



ST8 RYGA + P00



TMMa TOKIO 2 A + P00



NS9 MILANO 12 + DW8



SNUA MILANO 4 A + PD5A



NT2B TURYN 2 B + DT8B



ST4A UPPSALA 1 A + NMAA



NS6 HANOVER 6 + DW8



SET GL



SET G



SET GP



SET L

SIDE GLAZED PANELS*

HEIGHT Hz	GLAZED PANEL / GLASS TYPE	WIDTH Ld/Pd						
		up to 300 mm	up to 400 mm	up to 500 mm	up to 600 mm	up to 700 mm	up to 800 mm	up to 900 mm
2087 mm	PANEL WITH SAFETY GLASS	✓	✓	✓	✓	✓	✓	✓
	ANTI-BULGLARY RC2 PANEL WITH P4 GLASS	✓	✓	✓	✓	✓	✓	✓
do 2200 mm	PANEL WITH SAFETY GLASS	✓	✓	✓	✓	✓	✓	✓
	ANTI-BULGLARY RC2 PANEL WITH P4 GLASS	✓	✓	✓	✓	✓	✓	✓
do 2300 mm	PANEL WITH SAFETY GLASS	✓	✓	✓	✓	✓	✓	✓
	ANTI-BULGLARY RC2 PANEL WITH P4 GLASS	✓	✓	✓	✓	✓	✓	✓
do 2400 mm	PANEL WITH SAFETY GLASS	✓	✓	✓	✓	✓	✓	✓
	ANTI-BULGLARY RC2 PANEL WITH P4 GLASS	✓	✓	✓	✓	✓	✓	✓

SIDE GLAZED PANEL STANDARD WIDTH IN 50 MM INCREMENTS. FOR 10 MM INCREMENTS – EXTRA CHARGE +25%

ALUTHERM DOOR FRAME		
SIZE	HEIGHT Hz	WIDTH Sc
80	standard 2087 mm	918 mm
90N	not standard: 2150 mm	988 mm
	2200 mm	
90E	2250 mm	1031 mm
	2300 mm	
100E	2350 mm	1131 mm
	2400 mm	

FOR DOORS WITH INTEGRATED CLOSER DOOR FRAME TOTAL HEIGHT +3,5 mm.

To get complete price for set please sum up:

for THERMO PRIME:

- door price
- side / top panel price

for THERMO PREMIUM I OPTIMA:

- door price
- ALUTHERM door frame extra charge,
- side / top panel price

N

POWDER COATING*

	SIDE/ TOP GLAZED PANEL
GALA PALETTE	✓
GALACTICA PALETTE	✓
INTERGALACTICA PALETTE	✓
GALA OPEN PALETTE	✓



SET P



SET LP



SET LGP

TOP GLAZED PANELS*

HEIGHT Hd	GLAZED PANEL / GLASS TYPE	WIDTH Ld/B/Pd				
		up to 1150 mm	up to 1550 mm	up to 1950 mm	up to 2350 mm	up to 2950 mm
300 mm	PANEL WITH SAFETY GLASS	✓	✓	✓	✓	✓
400 mm		✓	✓	✓	✓	✓
500 mm		✓	✓	✓	✓	✓
300 mm	ANTI-BULGLARY RC2 PANEL WITH P4 GLASS	✓	✓	✓	✓	✓
400 mm		✓	✓	✓	✓	✓
500 mm		✓	✓	✓	✓	✓

TOP GLAZED PANEL STANDARD WIDTH IN 50 MM INCREMENTS. FOR 10 MM INCREMENTS – EXTRA CHARGE +25%

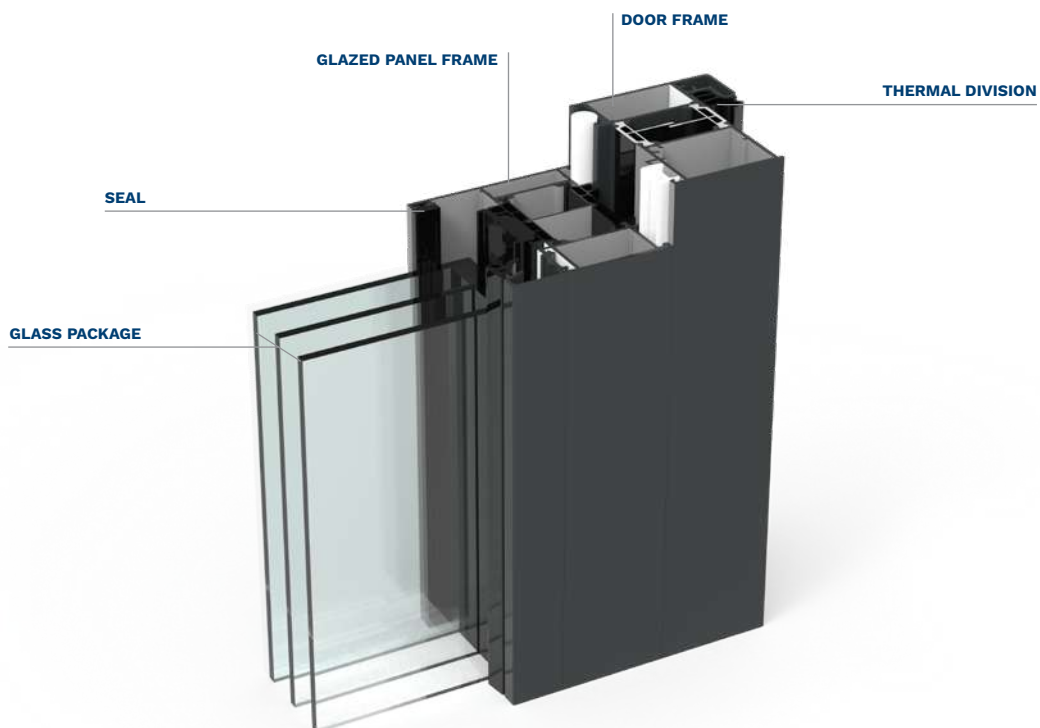

* EXTRA CHARGE

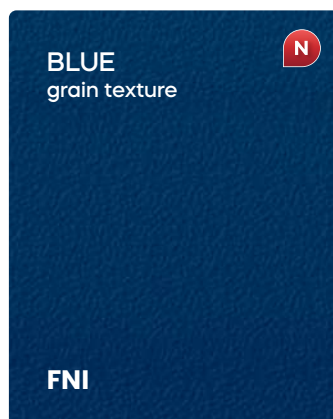
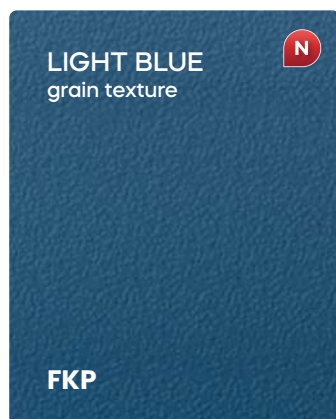
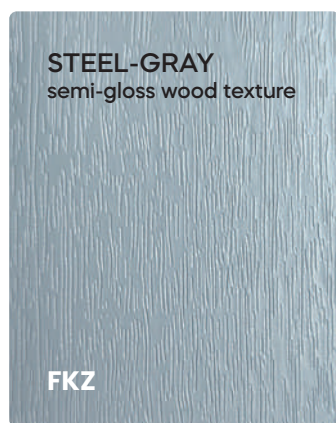



TWO-COLOURED DOOR*

To obtain a unique configuration of the door to our house, we can combine any two colors from the available TERRA palette. The outer side of the door leaf, as well as the outer frame, will then have a different color than the inner side. In this way, we can even better match the style of the door to the design of the façade and interior. That option is available with an extra charge.

Without extra charges, there is also available to order door leaf in a selected color with a frame in a different color.

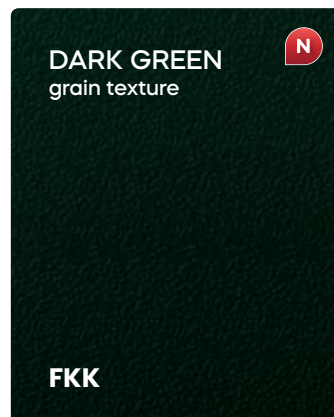

* EXTRA CHARGE

STANDARD ACCESSORIES SETS



PRAGA
HANDLE-HANDLE
LONG ESCUTCHEON

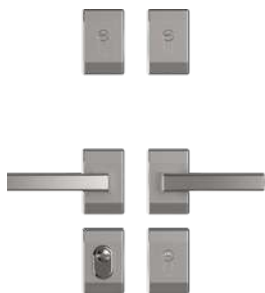

BERGEN
HANDLE-HANDLE
SPLIT ESCUTCHEON



PRAGA
HANDLE-HANDLE
LONG ESCUTCHEON
UPPER LOCK ESCUTCHEON
WITHOUT CYLINDER
PROTECTION



BERGEN
HANDLE-HANDLE
LONG ESCUTCHEON
UPPER LOCK ESCUTCHEON
WITHOUT CYLINDER
PROTECTION

CYLINDERS SET, KEYED ALIKE SYSTEM, AB SYSTEM (for doors with mortise locks – single cylinder)	CLASS 5
NUMBER OF KEYS	5 + 2
PRAGA OR BERGEN ESCUTCHEON	to choose from
HINGE CAPS MATCHING FITTING'S COLOUR	✓

EVO – CLASS 5 LOCK CYLINDER



SECURITY CLASS	CLASS 5
MECHANISM DURABILITY	100 000 cycles
NUMBER OF PINS	12 pins: 9 in two rows and 3 side pins
KEY TYPE	horizontal drilled
NUMBER OF KEY CODE COMBINATIONS	9 300 000
RESISTANCE TO BURGLARY CLASS	C
RESISTANCE TO CORROSION CLASS	C
FIRE RESISTANCE	✓
ANTY-DRILLING	two steel hardened nickel-plated anti-drilling pins in the body
EMERGENCY FUNCTION	no
NUMBER OF KEYS	5 keys made of 'new silver' (for final user) + 2 brass keys (for installer)
OTHER	code card
WARRANTY	2 years
tedee READY	no

AB SYSTEM



2 x Installer's keys
Installer's key „A“ operates the cylinder until „B“ key is used by final user.



5 x final keys
Use of „B“ key deactivates installer's keys. A sealed opaque bag includes set of „B“ keys and code card.

FITTINGS COLOURS

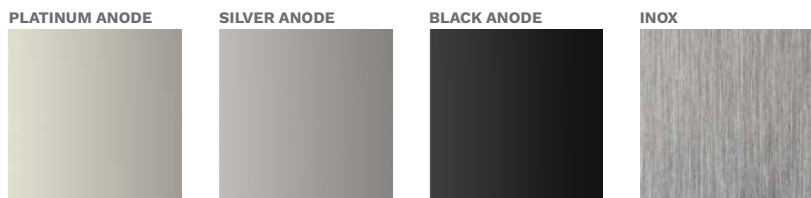

ONLY FOR HANDRAILS

LOCK CYLINDERS COLOURS

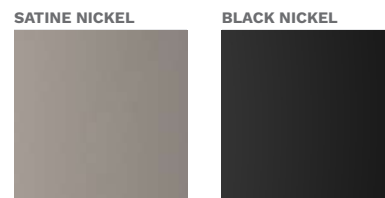

EXTRA CHARGE ACCESSORIES SETS



PRAGA
KNOB-HANDLE
LONG ESCUTCHEON



BERGEN
KNOB-HANDLE
SPLIT ESCUTCHEON



BERGEN
KNOB-HANDLE
LONG ESCUTCHEON ZAMEK
UPPER LOCK ESCUTCHEON
WITH CYLINDER
PROTECTION



AMSTERDAM / BERGEN
HANDRAIL-HANDLE
RING ESCUTCHEON
/ SPLIT ESCUTCHEON



AMSTERDAM / PRAGA
HANDRAIL-HANDLE
PRAGA ESCUTCHEON FOR HANDRAIL
/ LONG ESCUTCHEON

THERMO PREMIUM – AUXILIARY LOCK CYLINDER WITH PROTECTION	✓
KNOB-HANDLE SET	✓
6 CLASS LOCK CYLINDERS, KEYED ALIKE SYSTEM	✓
ADJUSTMENT FOR HANDRAIL WITH PUSHBUTTON	✓
HANDRAIL AMSTERDAM / MONTREAL 1800 mm, ELECTRIC STRIKE RECOMMENDED	✓
HANDRAIL AMSTERDAM / MONTREAL 1700 mm, ELECTRIC STRIKE RECOMMENDED	✓
HANDRAIL AMSTERDAM / MONTREAL 1500 mm, ELECTRIC STRIKE RECOMMENDED	✓
HANDRAIL AMSTERDAM / MONTREAL 1000 mm, ELECTRIC STRIKE RECOMMENDED	✓
HANDRAIL AMSTERDAM / MONTREAL 1800 mm WITH PUSHBUTTON AND ADJUSTMENT FOR HANDRAIL AND ELECTRIC STRIKE	✓
HANDRAIL AMSTERDAM / MONTREAL 1700 mm WITH PUSHBUTTON AND ADJUSTMENT FOR HANDRAIL AND ELECTRIC STRIKE	✓
HANDRAIL AMSTERDAM / MONTREAL 1500 mm WITH PUSHBUTTON AND ADJUSTMENT FOR HANDRAIL AND ELECTRIC STRIKE	✓
HANDRAIL AMSTERDAM / MONTREAL 1000 mm WITH PUSHBUTTON AND ADJUSTMENT FOR HANDRAIL AND ELECTRIC STRIKE	✓
HANDRAIL AMSTERDAM 1700 mm WITH WIRELESS PUSHBUTTON AND ELECTRIC STRIKE	✓
HANDRAIL AMSTERDAM 1500 mm WITH WIRELESS PUSHBUTTON AND ELECTRIC STRIKE	✓
HANDRAIL ROSTOCK 2000 mm (ONLY FOR OUTWARD OPENING DOORS)	✓
tedee PRO SET	✓

VITA – CLASS 6 LOCK CYLINDER

















SECURITY CLASS	CLASS 6
MECHANISM DURABILITY	100 000 cycles
NUMBER OF PINS	6 active pins
KEY TYPE	vertical incised
NUMBER OF KEY CODE COMBINATIONS	100 000
RESISTANCE TO BURGLARY CLASS	D
RESISTANCE TO CORROSION CLASS	C
FIRE RESISTANCE	✓
ANTY-DRILLING	two steel hardened anti-drilling pins in the body and cylinder
EMERGENCY FUNCTION	standard in key-key version
NUMBER OF KEYS	5 brass nickel-plated keys (for final user) + 2 brass keys (for installer)
OTHER	security card
WARRANTY	5 years (registered product)
tedee READY	✓



HANDRAILS















The visualizations show the door of a standard height of 2076 mm.















EXTRA CHARGES	OPTIMA 50	OPTIMA 60	THERMO PREMIUM 60	THERMO PREMIUM 75	THERMO PRIME 75
ELECTRIC STRIKE WITH DAY / NIGHT FEATURE RECOMMENDED FOR DOORS WITH HANDRAIL RECOMMENDED WITH POWER SUPPLY UNIT ADDITIONAL ACCESSORIES, SEE p. 103	✓	✓	✓	✓	✓
REVERSIVE ELECTRIC STRIKE RECOMMENDED FOR DOORS WITH HANDRAIL MOUNTED IN OPTIMA 60 DUO PASSIVE DOOR LEAF ADDITIONAL ACCESSORIES, SEE p. 103	-	✓	-	-	-
ELECTRIC STRIKE WITH DAY / NIGHT FEATURE MOUNTED IN OPTIMA 60 DUO PASSIVE LEAF RECOMMENDED FOR DOORS WITH HANDRAIL	-	✓	-	-	-
REVERSIVE ELECTRIC STRIKE MOUNTED IN OPTIMA 60 DUO PASSIVE LEAF RECOMMENDED FOR DOORS WITH HANDRAIL	-	✓	-	-	-
FACTORY-FITTED REED SWITCH	✓	✓	✓	✓	✓
DOOR SHORTENING WITHIN THE 0-100 mm RANGE (FOR SELECTED DESIGNS)	✓	✓	✓	✓	✓
DOOR TO SIZE (AVAILABLE ONLY WITH ALUTHERM DOOR FRAME AND FOR SELECTED DESIGNS)	-	✓	✓	✓	✓
HIGHER DOOR; TOTAL HEIGHT UP TO 2400 mm (AVAILABLE ONLY WITH ALUTHERM DOOR FRAME AND FOR SELECTED DESIGNS)	-	✓	✓	✓	✓
MORTISE LOCK	-	-	✓	✓	no extra charge
AUXILIARY LOCK FOR DOORS EQUIPPED WITH MORTISE LOCK	-	-	✓	✓	-
TWO-COLOUR DOOR, TERRA PALETTE	✓	✓	✓	✓	✓
INTERNAL DOOR LEAF REINFORCEMENT FOR SURFACE-MOUNTED CLOSER	✓	✓	✓	✓	✓
DRIP EDGE (RECOMMENDED FOR INWARD OPENED DOORS)	✓	✓	✓	✓	✓
ADJUSTMENT FOR HANDRAIL WITH PUSHBUTTON	-	✓	✓	✓	✓
MOUNTING KIT: FRAME SCREWS, WEDGES, MOUNTING ANCHORS (FRAME SCREWS FOR INSTALLATION IN ORDINARY CONCRETE, CERAMIC BRICK, SOLID SILICATE BRICK, WOOD)					no extra charge

HANDLES & ESCUTCHEONS		OPTIMA 50	OPTIMA 60	THERMO PREMIUM 60	THERMO PREMIUM 75	THERMO PRIME 75
	PRAGA HANDLE-HANDLE LONG ESCUTCHEON EXTERNAL ESCUTCHEON WITHOUT CYLINDER PROTECTION	✓	✓	✓	✓	✓
	PRAGA SINGLE-SIDED HANDLE LONG ESCUTCHEON EXTERNAL ESCUTCHEON WITHOUT CYLINDER PROTECTION (FOR HANDRAIL)	✓	✓	✓	✓	✓
	PRAGA KNOB-HANDLE LONG ESCUTCHEON EXTERNAL ESCUTCHEON WITHOUT CYLINDER PROTECTION	✓	✓	✓	✓	✓
	BERGEN HANDLE-HANDLE LONG ESCUTCHEON TD200 EXTERNAL ESCUTCHEON WITH CYLINDER PROTECTION	✓	✓	✓	✓	-
	BERGEN HANDLE-HANDLE LONG ESCUTCHEON TD1000 EXTERNAL ESCUTCHEON WITH CYLINDER PROTECTION	-	-	✓	✓	-
	BERGEN SINGLE-SIDED HANDLE LONG ESCUTCHEON EXTERNAL ESCUTCHEON WITH CYLINDER PROTECTION (FOR HANDRAIL)	-	-	✓	✓	-
	BERGEN KNOB-HANDLE LONG ESCUTCHEON TD200 EXTERNAL ESCUTCHEON WITH CYLINDER PROTECTION	-	-	✓	✓	-
	BERGEN KNOB-HANDLE LONG ESCUTCHEON TD1000 EXTERNAL ESCUTCHEON WITH CYLINDER PROTECTION	-	-	✓	✓	-
	BERGEN HANDLE-HANDLE SPLIT ESCUTCHEON	✓	✓	-	-	✓
	BERGEN SINGLE-SIDED HANDLE SPLIT ESCUTCHEON (FOR HANDRAIL)	✓	✓	-	-	✓
	BERGEN KNOB-HANDLE SPLIT ESCUTCHEON	✓	✓	-	-	✓
	BERGEN SPLIT ESCUTCHEON TW300 EXTERNAL ESCUTCHEON WITH CYLINDER PROTECTION	✓	✓	✓	✓	✓
	BERGEN SPLIT ESCUTCHEON EXTERNAL ESCUTCHEON WITHOUT CYLINDER PROTECTION	✓	✓	✓	✓	✓
	PRAGA SPLIT ESCUTCHEON EXTERNAL ESCUTCHEON WITHOUT CYLINDER PROTECTION	✓	✓	✓	✓	✓

HANDRAILS		OPTIMA 50	OPTIMA 60	THERMO PREMIUM 60	THERMO PREMIUM 75	THERMO PRIME 75
	AMSTERDAM 1800 mm RECTANGULAR CROSS-SECTION HANDRAIL (PROFILE 40 x 20 mm) ELECTRIC STRIKE RECOMMENDED	✓	✓	✓	✓	✓
	AMSTERDAM 1700 mm RECTANGULAR CROSS-SECTION HANDRAIL (PROFILE 40 x 20 mm) ELECTRIC STRIKE RECOMMENDED	✓	✓	✓	✓	✓
	AMSTERDAM 1500 mm RECTANGULAR CROSS-SECTION HANDRAIL (PROFILE 40 x 20 mm) ELECTRIC STRIKE RECOMMENDED	✓	✓	✓	✓	✓
	AMSTERDAM 1000 mm RECTANGULAR CROSS-SECTION HANDRAIL (PROFILE 40 x 20 mm) ELECTRIC STRIKE RECOMMENDED	✓	✓	✓	✓	✓
	AMSTERDAM 1800 mm RECTANGULAR CROSS-SECTION HANDRAIL WITH PUSHBUTTON (PROFILE 40 x 20 mm) ELECTRIC STRIKE INCLUDED	✓	✓	✓	✓	✓
	AMSTERDAM 1700 mm RECTANGULAR CROSS-SECTION HANDRAIL WITH PUSHBUTTON (PROFILE 40 x 20 mm) ELECTRIC STRIKE INCLUDED	✓	✓	✓	✓	✓
	AMSTERDAM 1500 mm RECTANGULAR CROSS-SECTION HANDRAIL WITH PUSHBUTTON (PROFILE 40 x 20 mm) ELECTRIC STRIKE INCLUDED	✓	✓	✓	✓	✓
	AMSTERDAM 1000 mm RECTANGULAR CROSS-SECTION HANDRAIL WITH PUSHBUTTON (PROFILE 40 x 20 mm) ELECTRIC STRIKE INCLUDED	✓	✓	✓	✓	✓
	AMSTERDAM 1800 mm RECTANGULAR CROSS-SECTION HANDRAIL WITH WIRELESS PUSHBUTTON (PROFILE 40 x 20 mm) ELECTRIC STRIKE NECESSARY	✓	✓	✓	✓	✓
	AMSTERDAM 1500 mm RECTANGULAR CROSS-SECTION HANDRAIL WITH WIRELESS PUSHBUTTON (PROFILE 40 x 20 mm) ELECTRIC STRIKE NECESSARY	✓	✓	✓	✓	✓
	MONTREAL 1800 mm CIRCULAR CROSS-SECTION HANDRAIL (PROFILE Ø 35 mm) ELECTRIC STRIKE RECOMMENDED	✓	✓	✓	✓	✓
	MONTREAL 1700 mm CIRCULAR CROSS-SECTION HANDRAIL (PROFILE Ø 35 mm) ELECTRIC STRIKE RECOMMENDED	✓	✓	✓	✓	✓
	MONTREAL 1500 mm CIRCULAR CROSS-SECTION HANDRAIL (PROFILE Ø 35 mm) ELECTRIC STRIKE RECOMMENDED	✓	✓	✓	✓	✓
	MONTREAL 1000 mm CIRCULAR CROSS-SECTION HANDRAIL (PROFILE Ø 35 mm) ELECTRIC STRIKE RECOMMENDED	✓	✓	✓	✓	✓
	MONTREAL 1800 mm CIRCULAR CROSS-SECTION HANDRAIL WITH PUSHBUTTON (PROFILE Ø 35 mm) ELECTRIC STRIKE INCLUDED	✓	✓	✓	✓	✓
	MONTREAL 1700 mm CIRCULAR CROSS-SECTION HANDRAIL WITH PUSHBUTTON (PROFILE Ø 35 mm) ELECTRIC STRIKE INCLUDED	✓	✓	✓	✓	✓
	MONTREAL 1500 mm CIRCULAR CROSS-SECTION HANDRAIL WITH PUSHBUTTON (PROFILE Ø 35 mm) ELECTRIC STRIKE INCLUDED	✓	✓	✓	✓	✓
	MONTREAL 1000 mm CIRCULAR CROSS-SECTION HANDRAIL WITH PUSHBUTTON (PROFILE Ø 35 mm) ELECTRIC STRIKE INCLUDED	✓	✓	✓	✓	✓
	ROSTOCK 2000 mm RECTANGULAR CROSS-SECTION HANDRAIL (PROFILE 40 x 20 mm) ONLY FOR OUTWARD-OPENING DOORS	-	-	✓	✓	✓

ACCESSORIES	OPTIMA 50	OPTIMA 60	THERMO PREMIUM 60	THERMO PREMIUM 75	THERMO PRIME 75
 WIDE-ANGLE VIEWER 50/80	✓	✓	✓	✓	✓
 4.3" ELECTRONIC VIEWER	✓	✓	✓	✓	✓
 2,4" ELECTRONIC VIEWER	✓	✓	✓	✓	✓
 ACCESS CONTROL NUMERIC KEYPAD	✓	✓	✓	✓	✓
 BUFFER POWER SUPPLY UNIT AWZG2 – 12V; RECOMMENDED FOR DOORS WITH ELECTRIC STRIKE	✓	✓	✓	✓	✓
 SWITCHING POWER SUPPLY PSC12015; RECOMMENDED FOR DOORS WITH ELECTRIC STRIKE	✓	✓	✓	✓	✓
 LOWER LOCKING PLATE	✓	✓	-	-	-
 INTEGRATED CLOSER	-	-	✓	✓	✓
 CLOSER GT 1500 STANDARD	✓	✓	✓	✓	✓
 CLOSER GT 1500 INTERLOCK	✓	✓	✓	✓	✓
 ALUMINUM DECORATIVE CAPS FOR HINGES MATCHING THE COLOUR OF THE OTHER FITTINGS	✓	✓	✓	✓	✓
 OPTIMA ALUMINUM THRESHOLD H20 mm	✓	✓	-	-	-
 THERMO PRIME, THERMO PREMIUM WARM ALUMINIUM THRESHOLD H20 mm	-	-	✓	✓	✓
 DRIP CAP MATCHING THE COLOUR OF THE DOOR LEAF	✓	✓	✓	✓	✓

ACCESSORIES	OPTIMA 50	OPTIMA 60	THERMO PREMIUM 60	THERMO PREMIUM 75	THERMO PRIME 75
 STEEL-WOODEN SIDE EXTENSION WIDTH 30 mm PERFOTHERM, DUOTHERM DOOR FRAMES	✓	✓	✓	✓	-
 STEEL-WOODEN SIDE EXTENSION WIDTH 60 mm PERFOTHERM, DUOTHERM DOOR FRAMES	✓	✓	✓	✓	-
 ALUMINUM SIDE EXTENSION WIDTH 25 mm ALUTHERM PRIME DOOR FRAME	-	✓	✓	✓	✓
 ALUMINUM SIDE EXTENSION WIDTH 33 mm ALUTHERM PRIME DOOR FRAME	-	✓	✓	✓	✓
 ALUMINUM SIDE EXTENSION WIDTH 44 mm ALUTHERM PRIME DOOR FRAME	-	✓	✓	✓	✓
 ALUMINUM SIDE EXTENSION WIDTH 55 mm ALUTHERM PRIME DOOR FRAME	-	✓	✓	✓	✓
 ALUMINUM SIDE EXTENSION WIDTH 108 mm ALUTHERM PRIME DOOR FRAME	-	✓	✓	✓	✓
 SUB THRESHOLD (EXTENSION) HARDENED EXPANDED POLYSTYRENE, AVAILABLE HEIGHTS: 70-250 mm INCREMENTS EVERY 10 mm, WIDTH 1200 mm	✓	✓	✓	✓	✓
 LOCK AND CYLINDER MAINTENANCE AGENT 25 ml	✓	✓	✓	✓	✓
 LOCK AND CYLINDER MAINTENANCE AGENT 100 ml	✓	✓	✓	✓	✓
 LOCK AND CYLINDER MAINTENANCE AGENT 400 ml	✓	✓	✓	✓	✓
 GERDA RESIST ULTRA INSULATION DUO TAPES	✓	✓	✓	✓	✓

LOCK CYLINDERS

	DOOR OPENING DIRECTION	MAIN LOCK PROFILE CYLINDERS		AUXILIARY LOCK PROFILE CYLINDERS		CLASS 5	CLASS 6
		MAIN LOCK ESCUTCHEON	CYLINDER SIZE	AUXILIARY LOCK ESCUTCHEON	CYLINDER SIZE		
OPTIMA 50 main lock: GERDA ZW1000, cam; auxiliary lock: GERDA ZW500	inwards	long escutcheon PRAGA BERGEN TD200	30/45	PRAGA BERGEN integrated TW300	G45/30	✓	✓
	outwards				G30/45	✓	✓
THERMO PREMIUM 60 OPTIMA 60 main lock: RC2 – GERDA ZW1000ZM, cog wheel cam; RC3 – GERDA ZW2000ZM, cog wheel cam; auxiliary lock: GERDA ZW500	inwards	long escutcheon BERGEN TD200, TD1000	35/55Z	BERGEN integrated TW300	G55/35	✓	✓
	outwards	long escutcheon PRAGA	30/50Z	PRAGA	G50/30	✓	✓
	inwards	long escutcheon BERGEN TD200, TD1000	35/55Z	BERGEN integrated TW300	G35/55	✓	✓
	outwards	long escutcheon PRAGA	50/30Z	PRAGA	G30/50	✓	✓
THERMO PREMIUM 60 MORTISE LOCK cam	inwards	split escutcheon BERGEN TW300	35/55			✓	✓
		long escutcheon PRAGA	30/50			✓	✓
	outwards	split escutcheon BERGEN TW300	35/55			✓	✓
		long escutcheon PRAGA	30/50			✓	✓
THERMO PREMIUM 60 MORTISE LOCK cam, set: single-sided handle & ring escutcheon	outwards	split escutcheon BERGEN TW300	35/35	✓	✓		
		long escutcheon PRAGA	30/35	✓	✓		
THERMO PREMIUM 75 main lock: GERDA ZW2000ZM cog wheel cam; auxiliary lock: GERDA ZW500	inwards	long escutcheon BERGEN TD200, TD1000	45/55Z	BERGEN integrated TW300	G55/45	✓	✓
		long escutcheon PRAGA	45/50Z	PRAGA	G50/45	✓	✓
	outwards	long escutcheon BERGEN TD200, TD1000	50/55Z	BERGEN integrated TW300	G50/55	✓	✓
		long escutcheon PRAGA	45/50Z	PRAGA	G45/50	✓	✓
THERMO PRIME 75 THERMO PREMIUM 75 MORTISE LOCK cam, set: handle-handle	universal	split escutcheon BERGEN TW300	45/55			✓	✓
		long escutcheon PRAGA	45/50			✓	✓
THERMO PRIME 75 THERMO PREMIUM 75 MORTISE LOCK cam, set: single-sided handle & ring escutcheon	inwards	split escutcheon BERGEN TW300	30/55			✓	✓
		long escutcheon PRAGA	30/50			✓	✓
	outwards	split escutcheon BERGEN TW300	35/45			✓	✓
		long escutcheon PRAGA	35/45			✓	✓

DOORS WITH TWO LOCKS: MAIN LOCK - KEY/KEY LOCK CYLINDER; AUXILIARY LOCK - KEY/THURNTUMB LOCK CYLINDER.
DOORS WITH ONE LOCK: MAIN LOCK - KEY/KEY LOCK CYLINDER OR LUB KEY/THUMBTURN LOCK CYLINDER.
MARKING G BEFORE THE SIZE OF THE LOCK CYLINDER INDICATES THUMBTURN.

THERMO PRIME / THERMO PREMIUM DOOR LEAF DIMENSIONS [mm]

SIZE	DOOR MODEL	Sp DOOR LEAF WIDTH, NARROW SIDE	Ss DOOR LEAF WIDTH, BROAD SIDE
80	THERMO PRIME THERMO PREMIUM	812	842
90N		882	912
90E		925	955
100E		1025	1055

SIZE	DOOR MODEL	Hs DOOR LEAF HEIGHT, NARROW SIDE	Hp DOOR LEAF HEIGHT, BROAD SIDE
2087	THERMO PRIME THERMO PREMIUM	2009	2039
2100	THERMO PRIME	2022	2052
2150		2072	2102
2200		2122	2152
2250		2172	2202
2300		2222	2252
2350		2272	2302
2400		2322	2352

ALUTHERM / DUOTHERM DOOR FRAME DIMENSIONS [mm]

SIZE	DOOR FRAME MODEL	Spr CLEAR OPENING	Sc TOTAL DOOR FRAME WIDTH	Sm RECOMMENDED MOUNTING CUT-OUT WIDTH*	Hc TOTAL DOOR FRAME HEIGHT***	Hm RECOMMENDED MOUNTING CUT-OUT HEIGHT FROM LEVEL 0**
80	DUOTHERM	796	896	916	2076	2086
90 N		866	966	986		
90 E		909	1009	1029		
100 E		1009	1109	1129		
80	ALUTHERM	787	918	938	STANDARD 2087 CUSTOM****	STANDARD 2097 CUSTOM****
90 N		857	988	1008		
90 E		900	1031	1051		
100 E		1000	1131	1151		

* INCLUDES MOUNTING CLEARANCE OF 10 mm PER SIDE

** INCLUDES MOUNTING CLEARANCE OF 10 mm

*** FOR DOORS WITH INTEGRATED CLOSER TOTAL HEIGHT OF THE FRAME +3.5 mm

**** THERMO PRIME ONLY

Spr – FOR DOORS OPENED AT 90°

THERMO PRIME 75 / THERMO PREMIUM 75

ALUTHERM 75

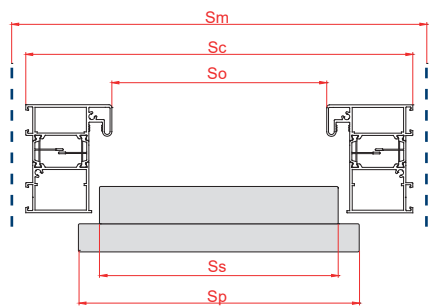
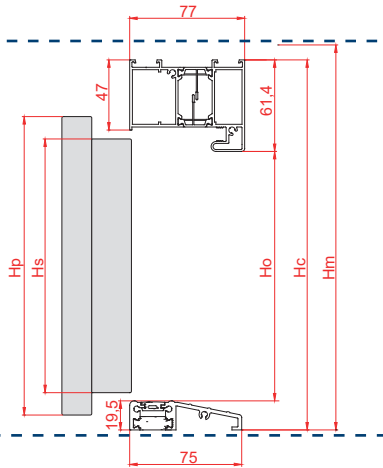

DUOTHERM 75

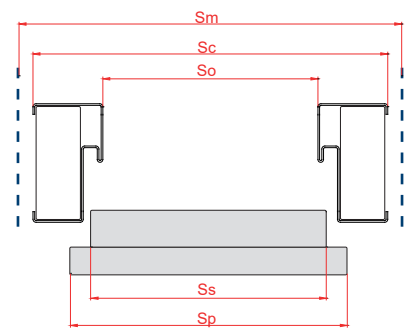
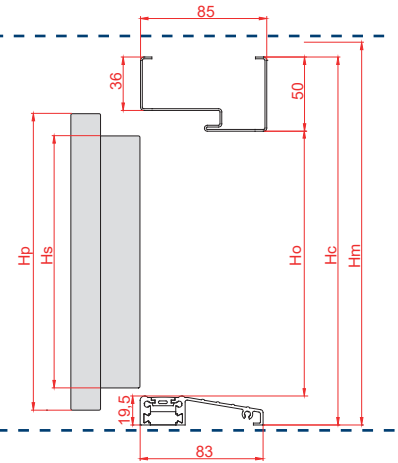

THERMO PREMIUM 60

ALUTHERM 60

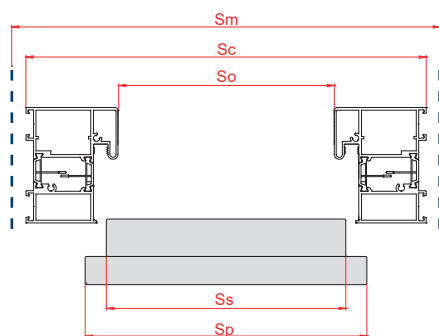
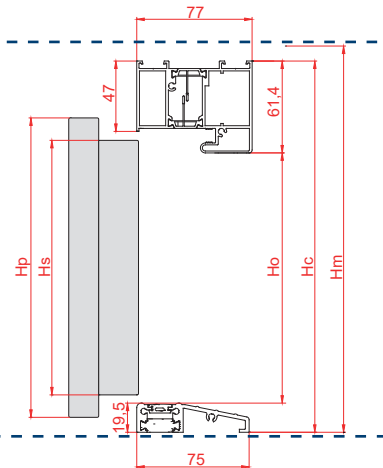

DUOTHERM 60

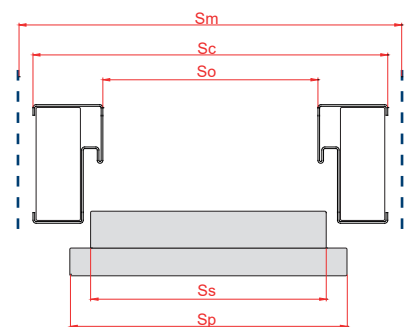
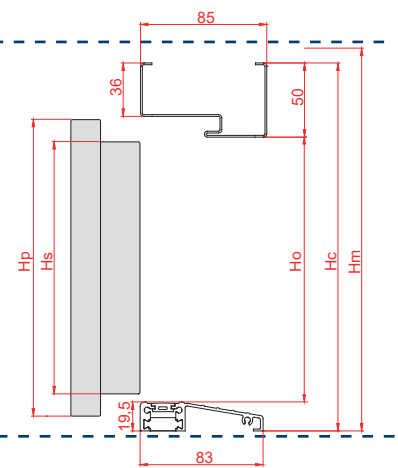

AVOID INSTALLING DARK COLOUR DOORS IN AREAS EXPOSED TO DIRECT AND LONG-TERM SUNLIGHT. DOOR INSTALLED AS EXTERIOR ENTRANCE DOOR AT SITES DIRECTLY EXPOSED TO WEATHER CONDITIONS (RAIN, WIND, ETC.) SHOULD OPEN OUTWARDS. IF MOUNTED AS AN EXTERIOR ENTRANCE DOOR, A ROOFING IS REQUIRED.

OPTIMA DOOR LEAF DIMENSIONS [mm]

SIZE	DOOR MODEL	Sp DOOR LEAF WIDTH, NARROW SIDE	Ss DOOR LEAF WIDTH, BROAD SIDE	Hs DOOR LEAF HEIGHT, NARROW SIDE	Hp DOOR LEAF HEIGHT, BROAD SIDE
80N	OPTIMA	782	812	2023	2038,5
80		812	842		
90N		882	912		
90E		925	955		
100E		1025	1055		
90E + 30	OPTIMA DUO 60	1182	1242		
90E + 40		1282	1342		
90E + 50		1382	1442		

ALUTHERM, PERFOTHERM, FB DOOR FRAME DIMENSIONS [mm]

SIZE	DOOR FRAME MODEL	Spr CLEAR OPENING	Sc TOTAL DOOR FRAME WIDTH	Sm RECOMMENDED MOUNTING CUT-OUT WIDTH*	Hc TOTAL DOOR FRAME HEIGHT	Hm RECOMMENDED MOUNTING CUT-OUT HEIGHT FROM LEVEL 0**
80N	PERFOTHERM FB	766	866	886	2076	2086
80		796	896	916		
90 N		866	966	986		
90 E		909	1009	1029		
100 E		1009	1109	1129		
80	ALUTHERM	787	918	938	2087	2097
90 N		857	988	1008		
90 E		900	1031	1051		
100 E		1000	1131	1151		

* INCLUDES MOUNTING CLEARANCE OF 10 mm PER SIDE

** INCLUDES MOUNTING CLEARANCE OF 10 mm

Spr – FOR DOORS OPENED AT 90°

OPTIMA 60

ALUTHERM 60

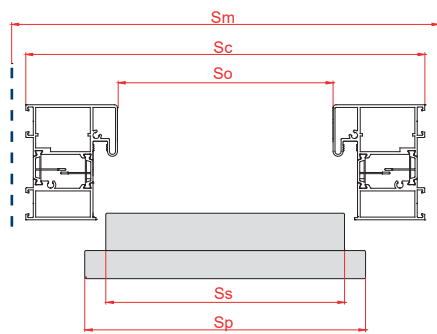
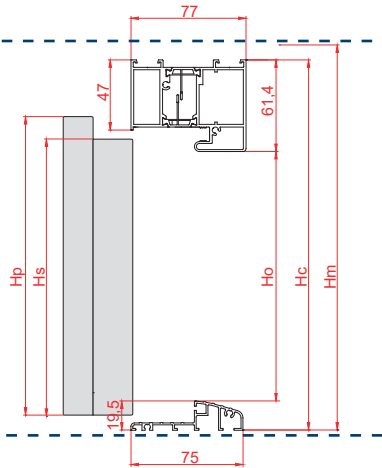

PERFOTHERM 60

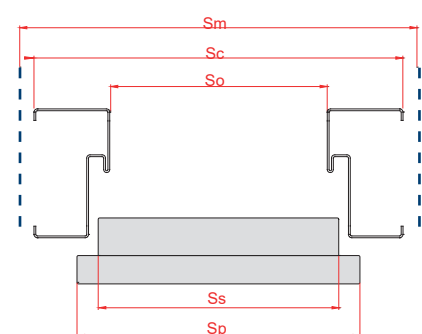
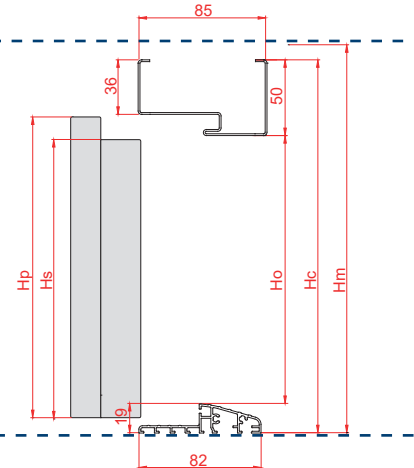

OPTIMA 50

PERFOTHERM 50

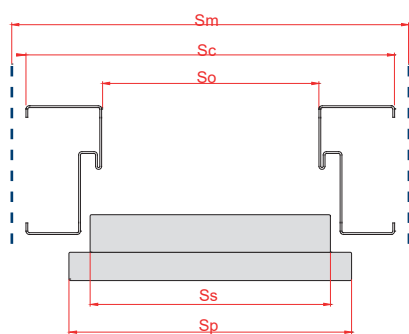
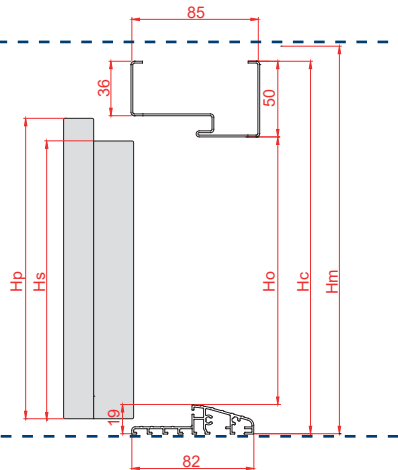

FB

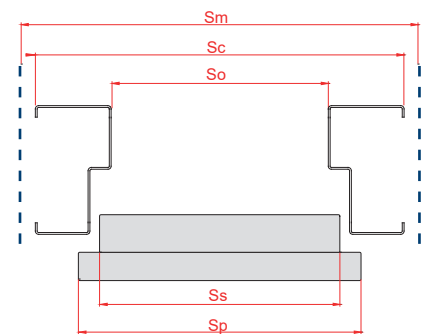
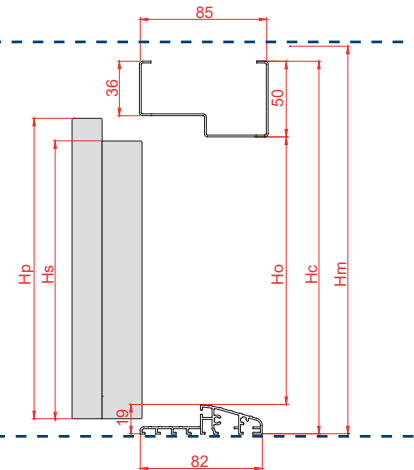

AVOID INSTALLING DARK COLOUR DOORS IN AREAS EXPOSED TO DIRECT AND LONG-TERM SUNLIGHT. DOOR INSTALLED AS EXTERIOR ENTRANCE DOOR AT SITES DIRECTLY EXPOSED TO WEATHER CONDITIONS (RAIN, WIND, ETC.) SHOULD OPEN OUTWARDS. IF MOUNTED AS AN EXTERIOR ENTRANCE DOOR, A ROOFING IS REQUIRED.

FN DOOR FRAME DIMENSIONS FOR OPTIMA [mm]

SIZE	DOOR FRAME MODEL	Sc1 TOTAL DOOR FRAME WIDTH	Sc2 TOTAL DOOR FRAME WIDTH	Sm RECOMMENDED MOUNTING CUT-OUT WIDTH*	Hc1 TOTAL DOOR FRAME HEIGHT	Hc2 TOTAL DOOR FRAME HEIGHT	Hm RECOMMENDED MOUNTING CUT-OUT HEIGHT FROM LEVEL 0**
80N	FN	862	797	817	2075	2041	2051
80		892	827	847			
90N		962	897	917			
90E		1005	940	960			
100E		1105	1040	1060			

ALUTHERM, PERFOTHERM DOOR FRAME DIMENSIONS FOR OPTIMA 60 DUO [mm]

SIZE	DOOR FRAME MODEL	Spr CLEAR OPENING	Sc TOTAL DOOR FRAME WIDTH	Sm RECOMMENDED MOUNTING CUT-OUT WIDTH*	Hc TOTAL DOOR FRAME HEIGHT	Hm RECOMMENDED MOUNTING CUT-OUT HEIGHT FROM LEVEL 0**
80	PERFOTHERM	796	896	916	2076	2086
80+30		1087	1187	1207		
80+40		1187	1287	1307		
80+50		1287	1387	1407		
90 E		909	1009	1029		
90 E +30		1200	1300	1320		
90 E +40		1300	1400	1420		
90 E +50		1400	1500	1520		
100 E		1009	1109	1129		
100 E +30		1300	1400	1420		
100 E +40		1400	1500	1520		
100 E +50		1500	1600	1620		
80		ALUTHERM	787	918		
80+30	1078		1209	1229		
80+40	1178		1309	1329		
80+50	1278		1409	1429		
90 E	900		1031	1051		
90 E +30	1191		1322	1342		
90 E +40	1291		1422	1442		
90 E +50	1391		1522	1542		
100 E	1000		1131	1151		
100 E +30	1291		1422	1442		
100 E +40	1391		1522	1542		
100 E +50	1491		1622	1642		

* INCLUDES MOUNTING CLEARANCE OF 10 mm PER SIDE

** INCLUDES MOUNTING CLEARANCE OF 10 mm

Spr – FOR DOORS OPENED AT 90°

OPTIMA 50

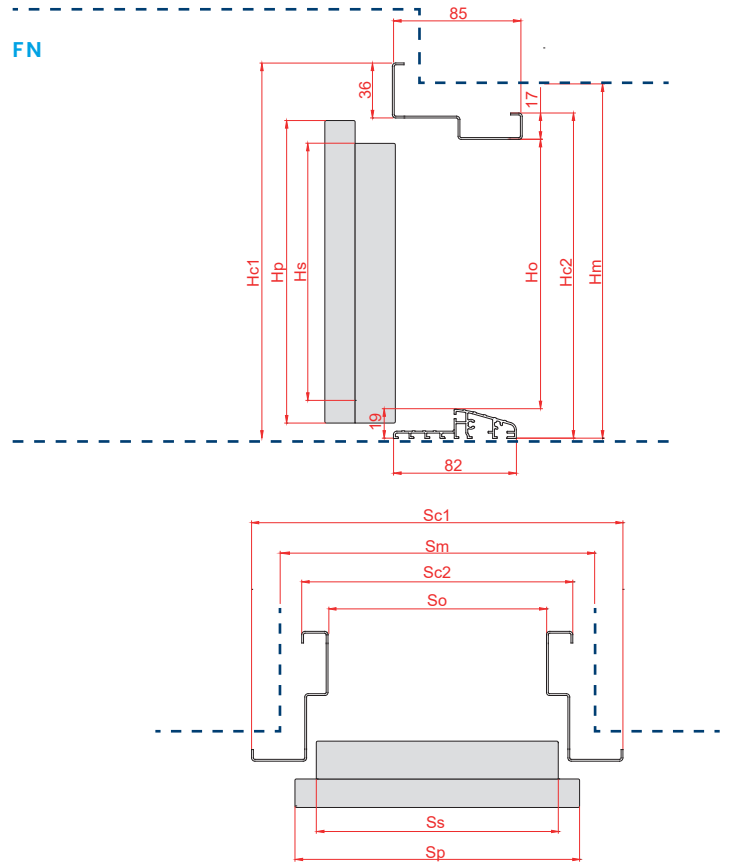

OPTIMA 60 DUO

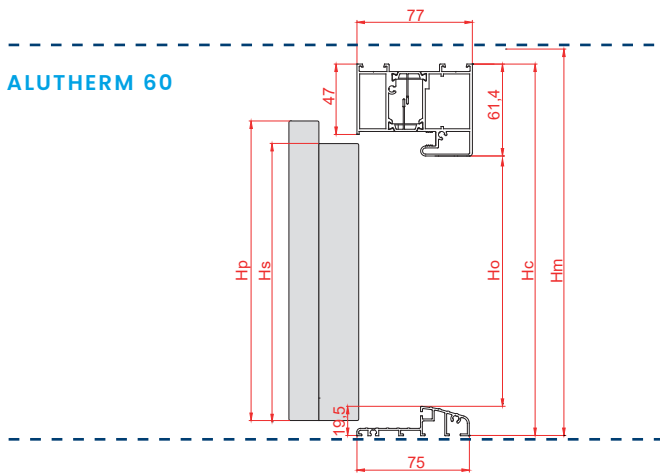

ALUTHERM 60

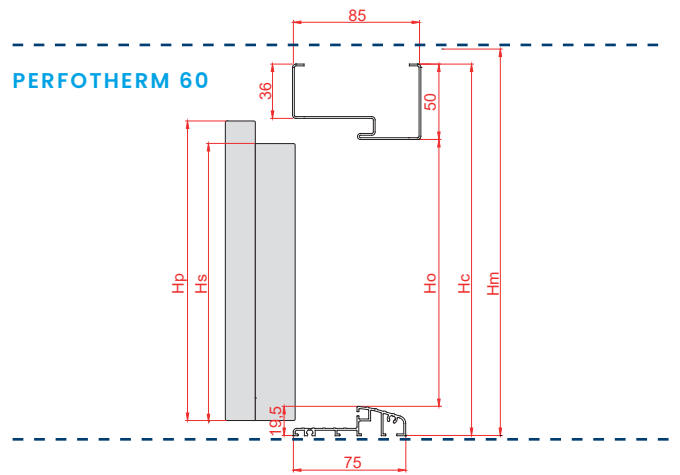
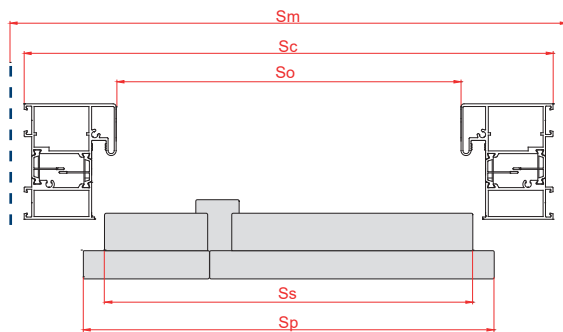

PERFOTHERM 60

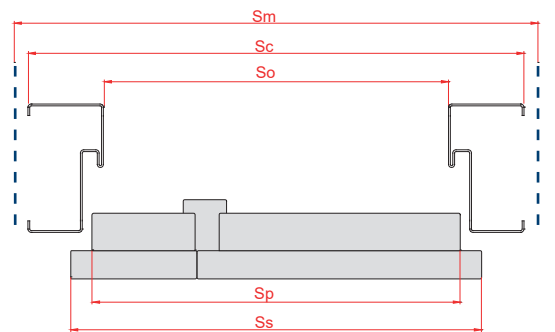

AVOID INSTALLING DARK COLOUR DOORS IN AREAS EXPOSED TO DIRECT AND LONG-TERM SUNLIGHT. DOOR INSTALLED AS EXTERIOR ENTRANCE DOOR AT SITES DIRECTLY EXPOSED TO WEATHER CONDITIONS (RAIN, WIND, ETC.) SHOULD OPEN OUTWARDS. IF MOUNTED AS AN EXTERIOR ENTRANCE DOOR, A ROOFING IS REQUIRED.



Gerda Sp. z o.o.

Sokołów, ul. Sokołowska 49
05-806 Komorów
POLAND
Phone (+48 22) 329 10 30

e-mail: export@gerda.pl

www.gerda.pl/en/

This catalogue does not constitute an offer under the provisions of law and is merely informational.

Gerda Sp. z o.o., committed to continuously improving its products and services, reserves the right (without prior notice) to introduce changes to products that, due to the printing material preparation process, may not be included in this material.

Despite all the effort and care in controlling the presented content, substantial or printing errors may occur.

Colours presented herein may differ from the original due to different colour reproduction technique in the printing process. The owner of the copyright for this catalogue, as well as Gerda Sp. z o.o. logotypes and graphics, is Gerda Sp. z o.o.

It is prohibited to copy or distribute any content and material without the prior consent of Gerda Sp. z o.o.

Distributor:

